

1 Stěny se zavěšenými dveřmi

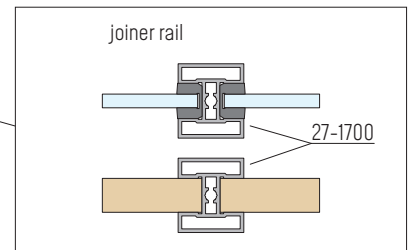

Hliníková konstrukce vyplněná sklem nebo deskou, se závěsnými dveřmi (jednoduché nebo dvojité) v kombinaci s horním a bočním pevným panelem, v mnoha konfiguracích. Maximální výška konstrukce je 3 m. Délka celého zařízení nesmí přesáhnout 4 m a maximální šířka jednoho pevného panelu nebo zavěšených dveří je 1 m. Maximální výška nosníku – 1 m a délka – 2 m.

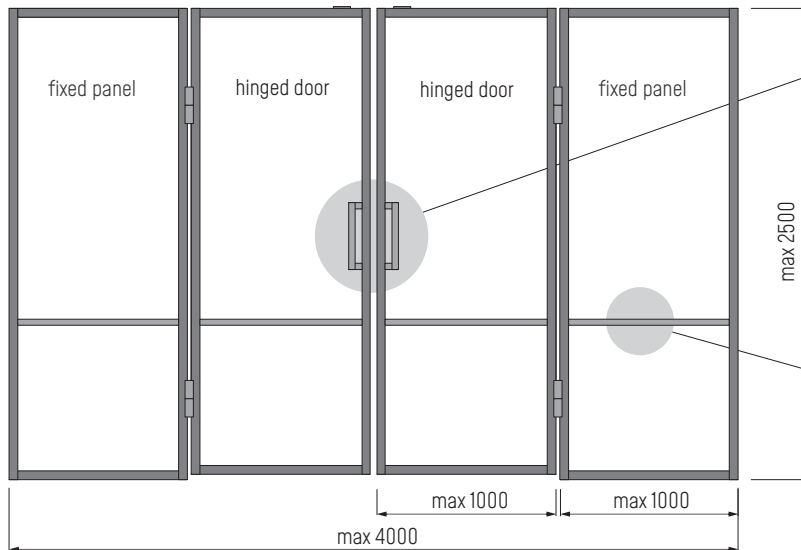
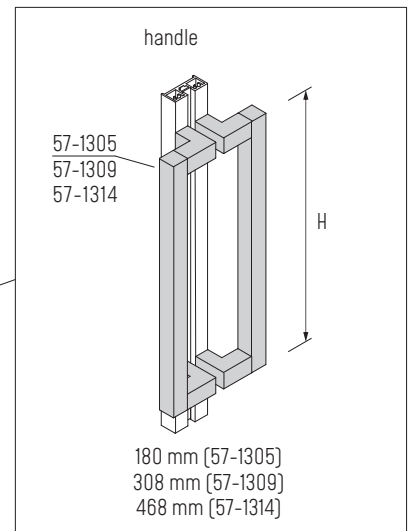
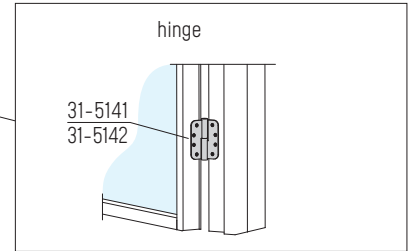
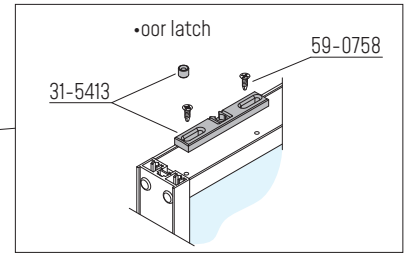
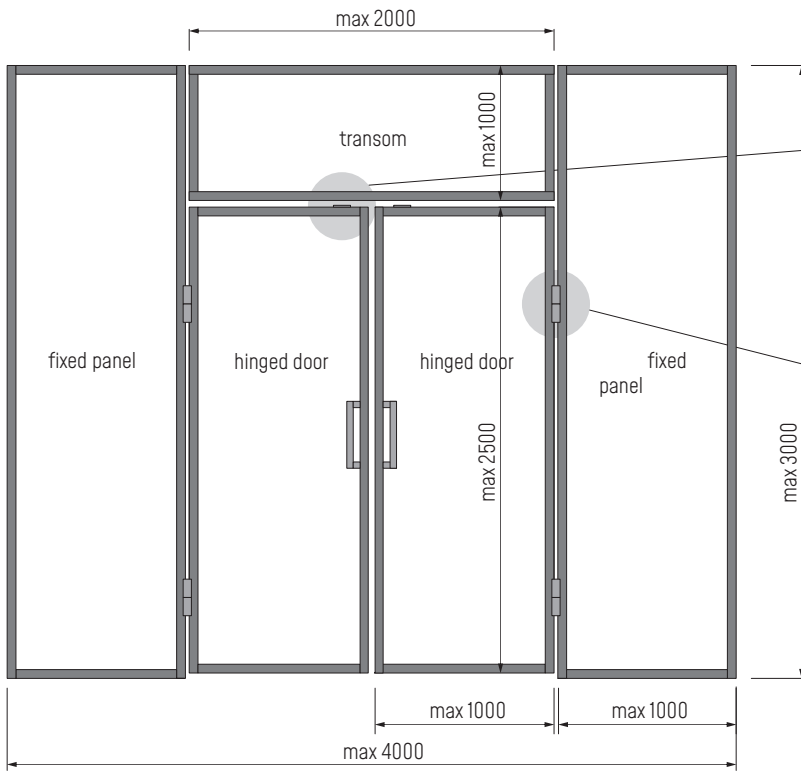

CONFIGURATION EXAMPLES • EXAMPLES OF DIVISIONS AND FILLINGS

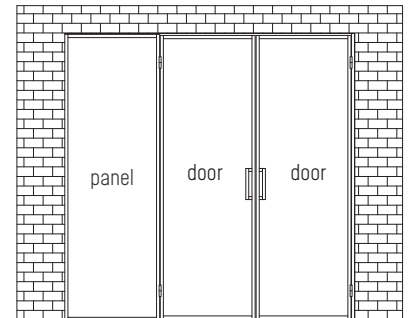
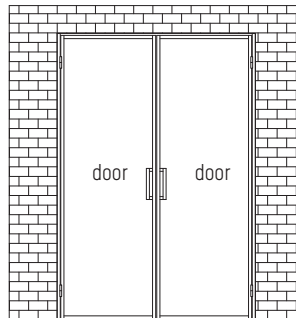
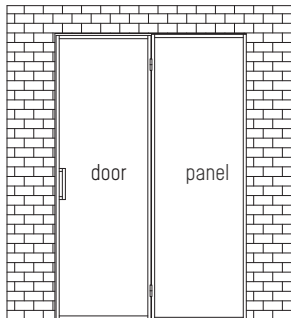
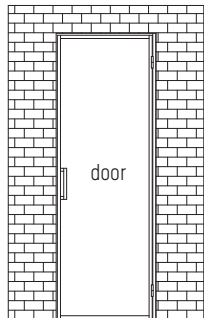
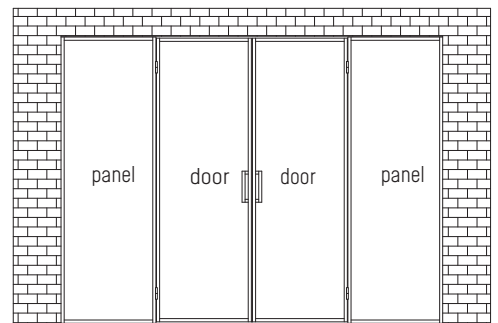
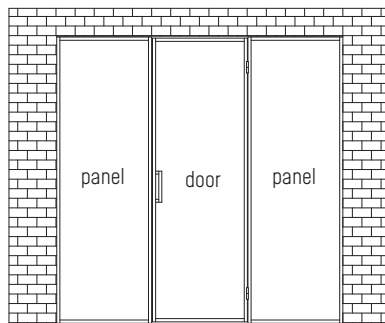
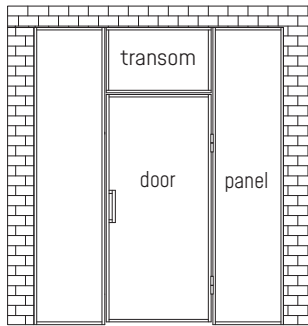
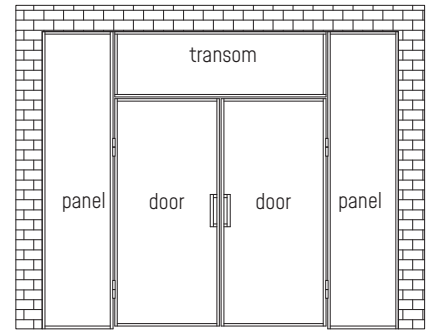
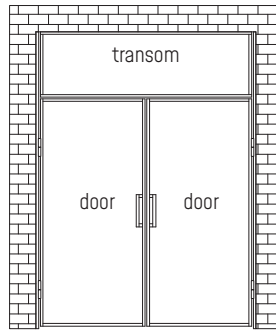
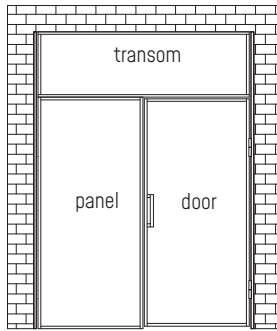
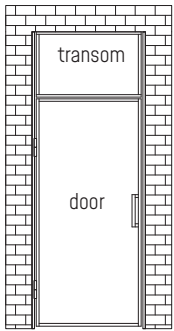

EXAMPLES OF DIVISIONS AND FILLINGS



TECHNICAL DETAILS

TRANSOM WITH FIXED PANEL

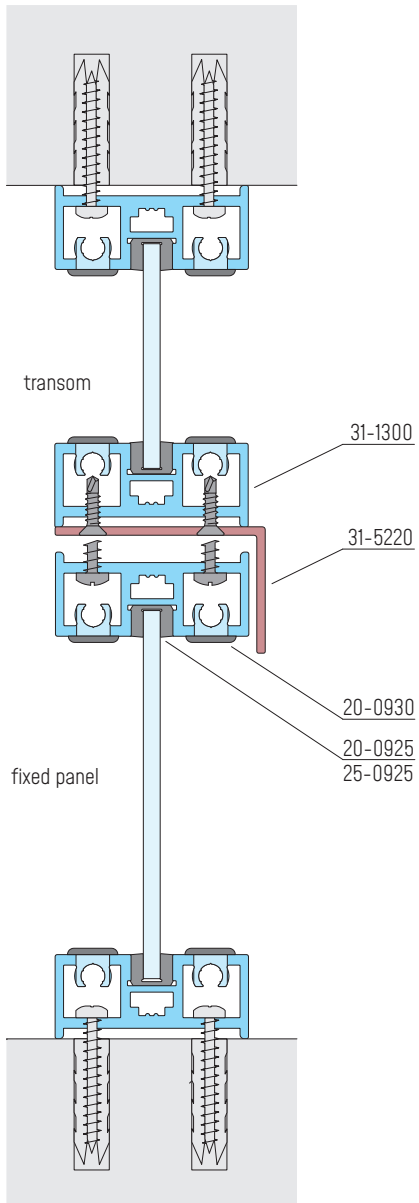

TRANSOM WITH HINGED DOORS

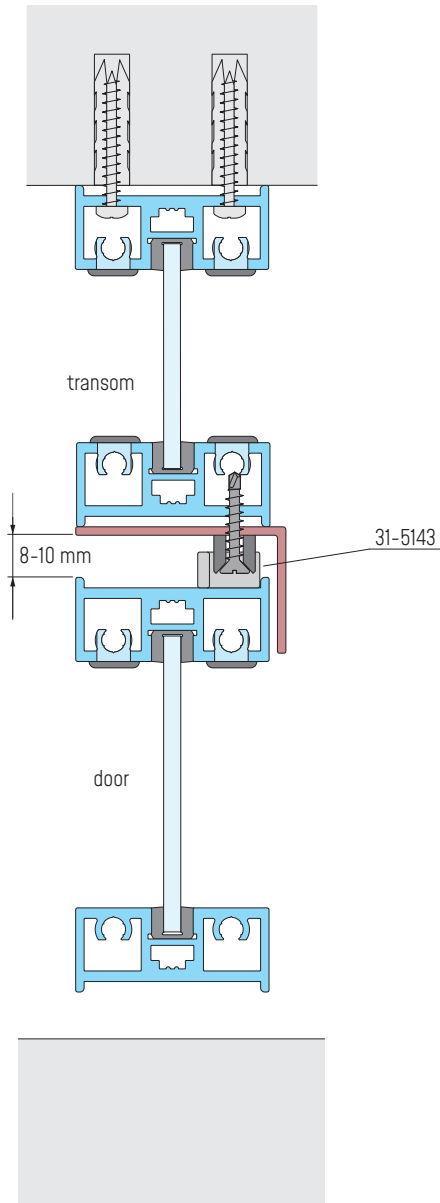

FIXED PANEL

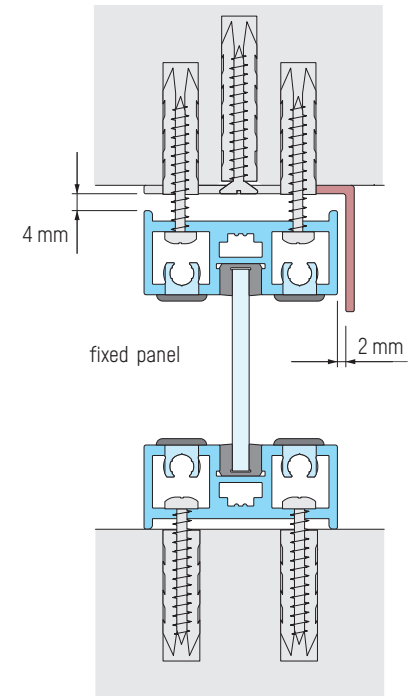

JOINING PROFILES IN THE CORNER

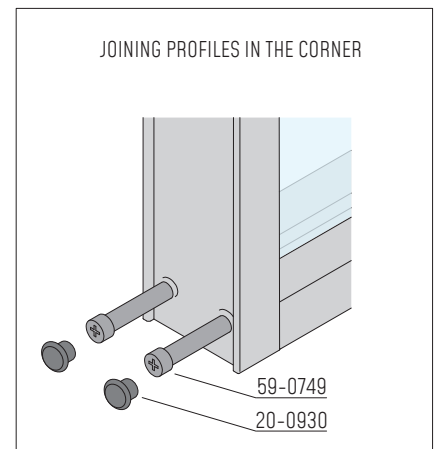

TECHNICAL DETAILS

FIXED PANEL ADJUSTMENT OPTION

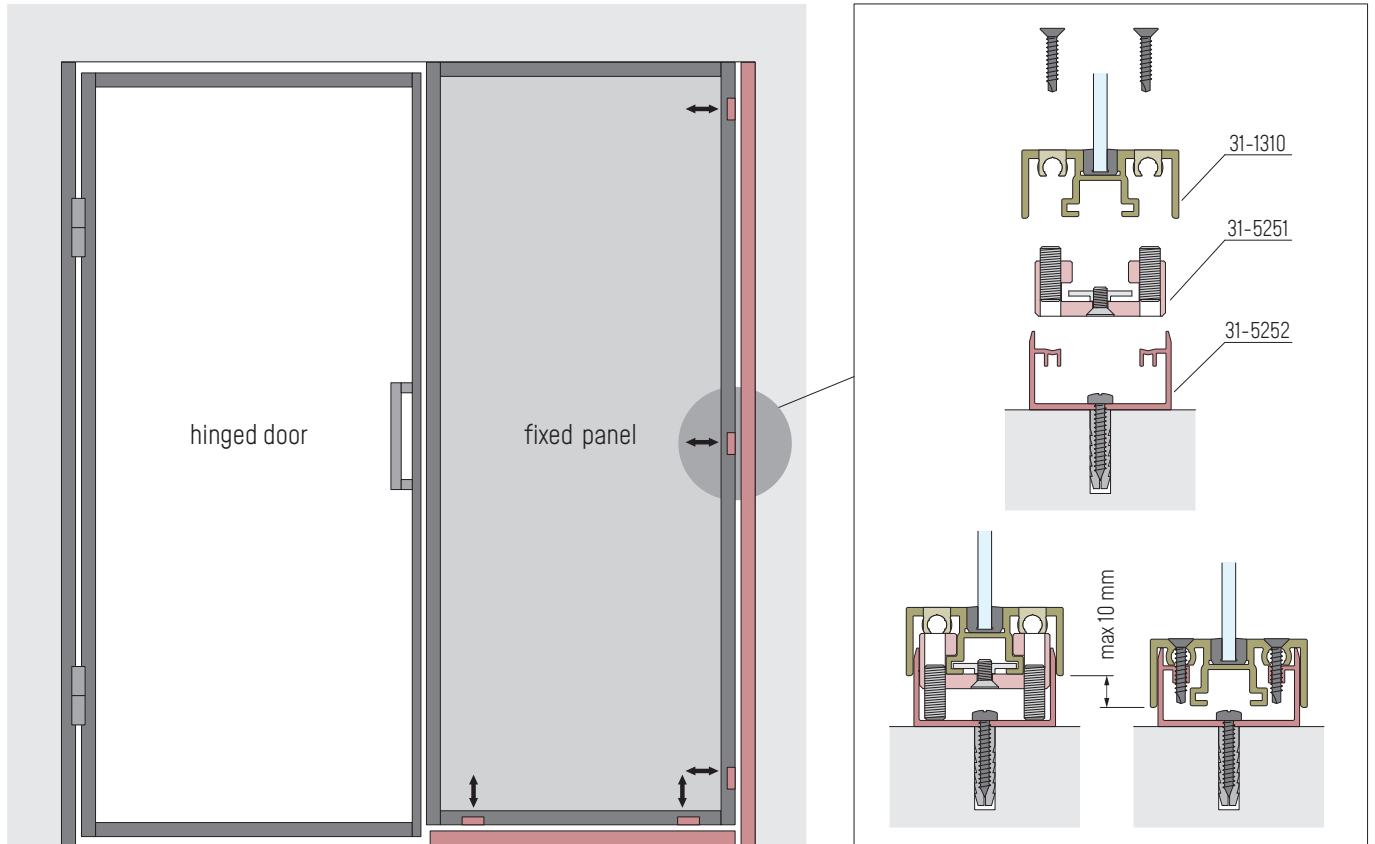

adjustment c-channel bar

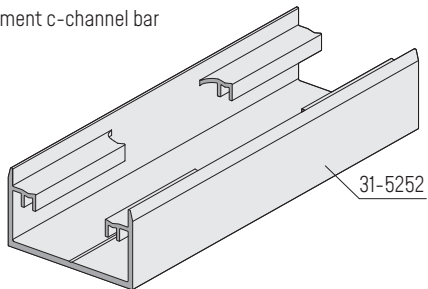

adjustment insert

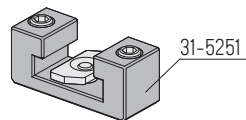

masking plate

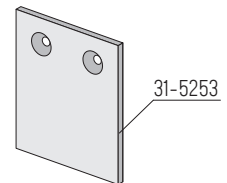

[5] SYSTEM COMPONENTS

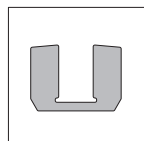

20-0925
GLAZIN STRIP
CM, PR

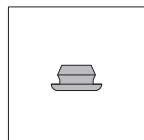

20-0930
KOREK
PLUG
AN, CZ

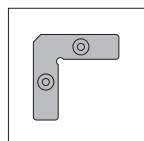

21-1301
SMALL FIXING BRACKET

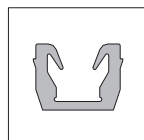

25-0925
AL25 SERIES 4 MM GASKET
CM, PR

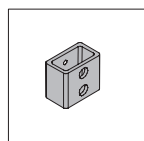

26-0181
AL26 MASKING STRIP HOLDER

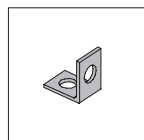

26-0182
AL26 MASKING STRIP
CATCH

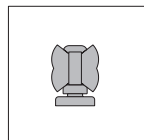

27-0501
AL27 BOTTOM SLIDING GUIDE
CZ, SZ

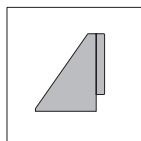

27-0980
AL27 BOTTOM STOPPER
AN, CM

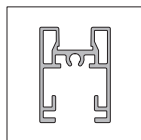

27-1400
AL27 RAIL, 2750 MM
AN, CM

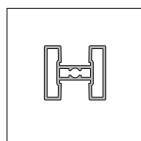

27-1700
AL27 SINGLE DOOR JOINER RAIL, 2750 MM
AN, CM

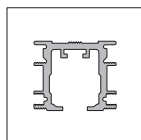

27-2110
AL27-2 TOP TRACK 2, 5000 MM

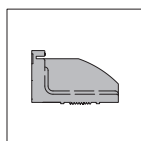

27-2130
AL27-2 ANGLE BRACKET

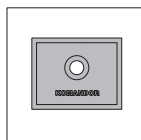

27-2131
AL27-2 SPACER WASHER

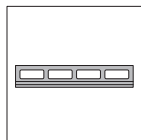

27-2140
AL27-2 SPACER INSERT

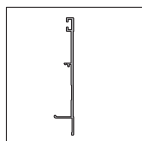

27-2180
AL27-2 CEILING MASKING STRIP, 5000
MM AN, CM

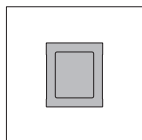

27-2181
AL27-2 CEILING TRACK PLUG
AN, CM

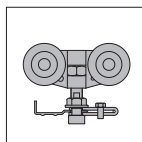

31-0600
LUMI TOP ROLLER

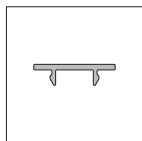

31-0895
AL31 MASKING STRIP 2750 MM
AN, CM

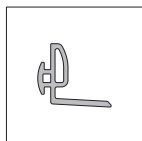

31-0922
AL31 DOOR FRAME GASKET
CZ, SJ

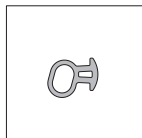

31-0923
AL31 DOOR FRAME CASING GASKET
CZ, SJ

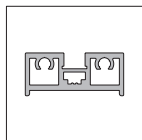

31-1300
AL31 DOOR PROFILE 3050 MM
AN, CM

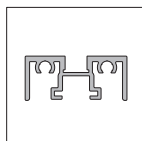

31-1310
AL31 OPEN RAIL 3050MM
AN, CM

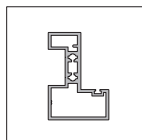

31-1320
AL31 DOOR FRAME 3050 MM
AN, CM

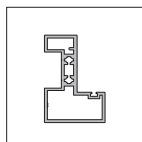

31-1321
AL31 DOOR FRAME 3550 MM
AN

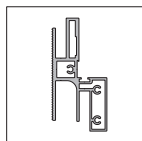

31-1322
AL31 DOOR FRAME 5300
MM AN, CM

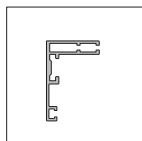

31-1603
AL31 DOOR FRAME CASING 30, 5300
MM AN, CM

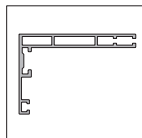

31-1607
AL31 DOOR FRAME CASING 70, 5300
MM AN, CM

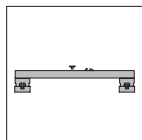

31-2691
LUMI AIR SPRING
COMPONENTS

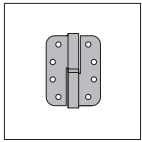

31-5141
AL31 BUTT HINGE, LEFT
CM, MS

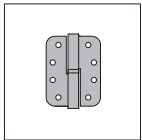

31-5142
AL31 BUTT HINGE, RIGHT
CM, MS

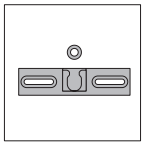

31-5143
LUMI DOOR LATCH

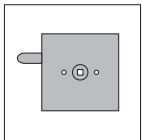

31-5144L
LUMI DOOR LOCK, LEFT
CM, MS

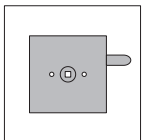

31-5144P
LUMI DOOR LOCK, RIGHT
CM, MS

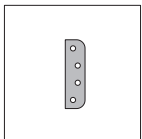

31-5145
BUTT HINGE SPACER
CM, MS

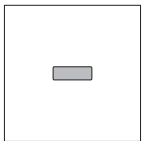

31-5210
LUMI FLAT BAR 12X4x3000 MM
AN, CM

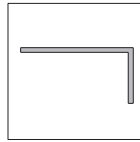

31-5220
LUMI ANGLE 50x25x4000 MM
AN, CM

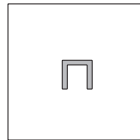

31-5240
LUMI C-CHANNEL BAR 12x12x3000 MM
AN, CM

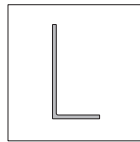

31-5250
LUMI FIXING BRACKET 50x25x2
AN, CM

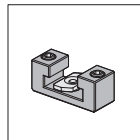

31-5251
LUMI ADJUSTMENT INSERT

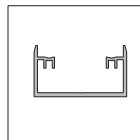

31-5252
LUMI C-CHANNEL BAR FOR ADJUSTMENT 4000 MM
AN, CM

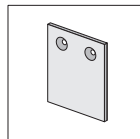

31-5253
MASKING PLATE OF LUMI ADJUSTABLE
PANEL MS, CM

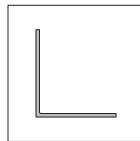

31-5260
LUMI DOOR CASING FIXING BRACKET 60x60x40

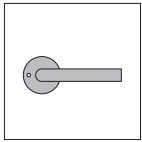

57-1300
LUMI DOOR HANDLE WITH ROUND PLATE
CM. MS

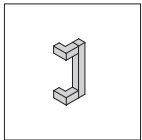

57-1305
LUMI HANDLE 160 MM
CM. MS

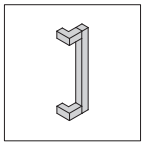

57-1309
LUMI HANDLE 288 MM
CM. MS

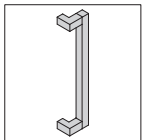

57-1314
LUMI HANDLE 448 MM
CM. MS

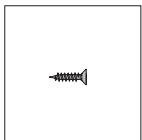

59-0702
MOUNTING SCREW 3,5x16 MM

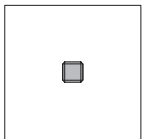

59-0719
HEADLESS SET SCREW M5x5

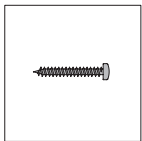

59-0728
MOUNTING SCREW 3,9x38 MM

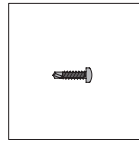

59-0730
CYLINDRICAL HEAD SELF DRILLING SCREW 3,5x16

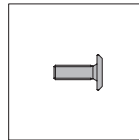

59-0731
SOCKET HEAD SCREW
M6x18

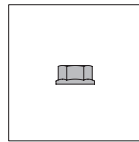

59-0732
SECURING NUT M6

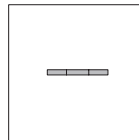

59-0733
6,4 MM PLAIN WASHER

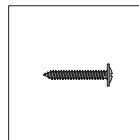

59-0739
SCREW WITH WASHER 3,5x25

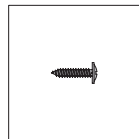

59-0740
SCREW WITH WASHER 3,5x13

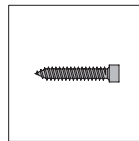

59-0749
MOUNTING SCREW 6,3x35

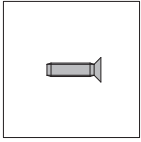

59-0751
COUNTERSUNK HEAD SELF-FORMING SCREW M5x10

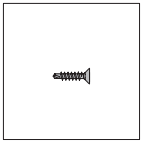

59-0758
COUNTERSUNK SELF DRILLING SCREW 3.5x16

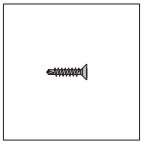

59-0759
COUNTERSUNK SELF DRILLING SCREW 3.5x19

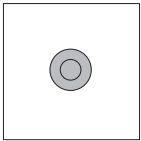

59-2002
SCREW PLUG
AN, CM