

TYPLOGIES

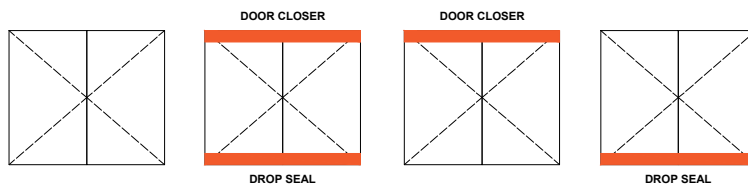
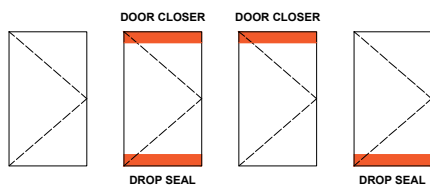
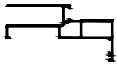

1  GT60-1 - 1457 gr/m | Frame

2  GT60-2 - 935 gr/m | Frame

3  GT24 - 1035 gr/m | Door frame

4  GT34 - 1645 gr/m | Door frame

5  GT14-B KIT | Door pivot

6  WB02 | Drop seal

7  GT60-KIT | Corner

8  GT60-S | Support fitting

9  DG02 | Rubber

10  GTQ-A | Rubber

11  S38 | Polycarbonate Gasket

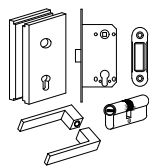
A  LOCK WITH CYLINDER

B  WC LOCK

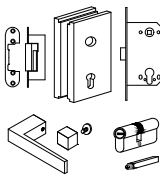
C  LOCK WITH ELECTRIC STRIKE PLATE

D  HORIZONTAL MAGNETIC LOCK

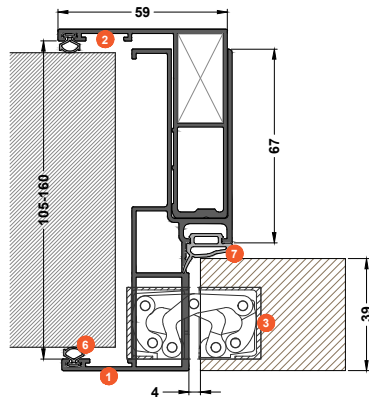
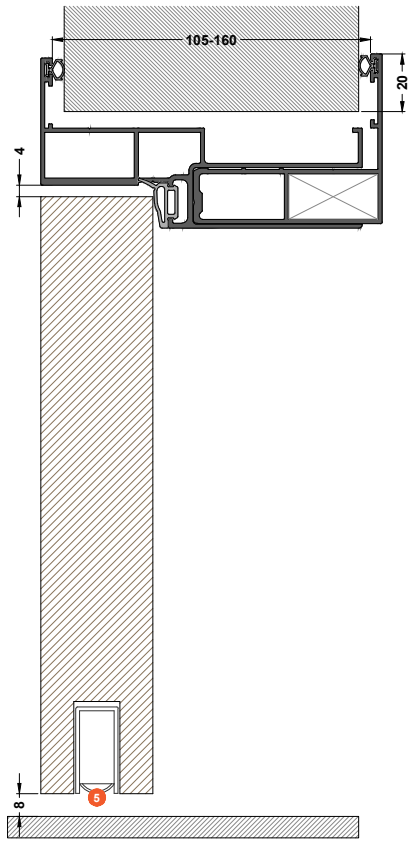

TYPOLOGIES

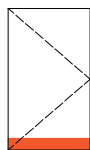
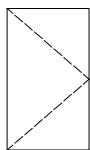

DROP SEAL

1  GT60-1 - 1457 gr/m | Frame

2  GT60-2 - 935 gr/m | Frame

3  GF01-03 | Concealed 3D Hinge + plates
| (GT60-03-SPH-KIT)

4  GT60-KIT | Corner

5  WB02 | Drop seal

6  DG02 | Rubber

7  GTQ-A | Rubber

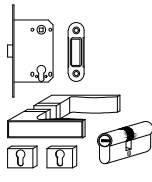
A  LOCK WITH CYLINDER

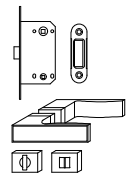
B  WC LOCK

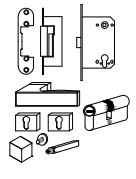
C  LOCK WITH ELECTRIC STRIKE PLATE

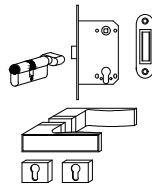
D  WC LOCK WITH CYLINDER AND BUTTON

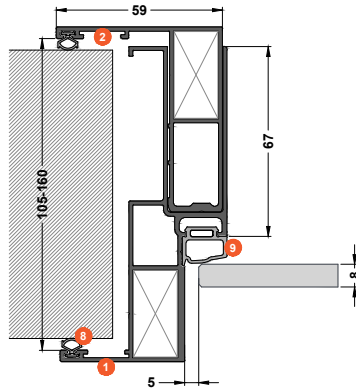
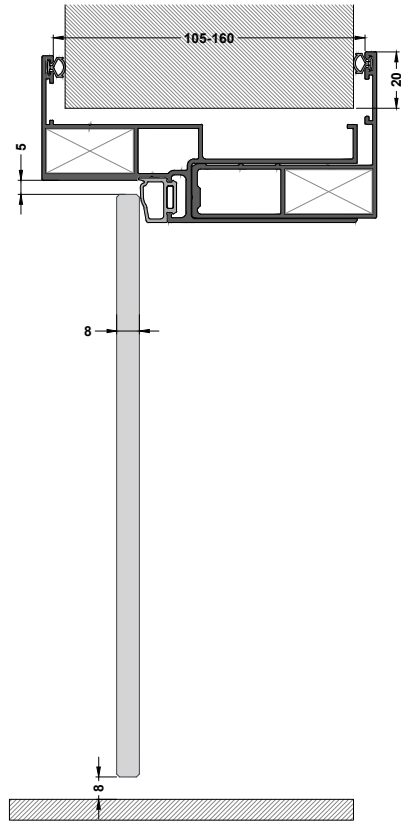

TPOLOGIES

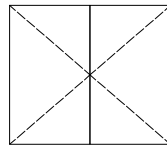

1  GT60-1 - 1457 gr/m | Frame

2  GT60-2 - 935 gr/m | Frame

3  DH12 | Hinge

4  DH13 | Hinge

5  DL04 | Lock

6  DL09A | Strike plate

7  GT60-KIT | Corner

8  DG02 | Rubber

9  GTQ-B | Rubber