

## 1 Stěny se zavěšenými dveřmi

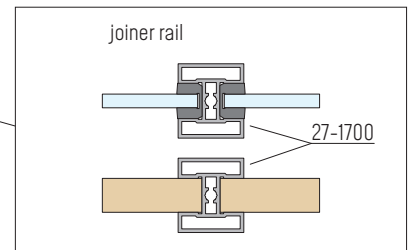

Hliníková konstrukce vyplněná sklem nebo deskou, se závěsnými dveřmi (jednoduché nebo dvojité) v kombinaci s horním a bočním pevným panelem, v mnoha konfiguracích. Maximální výška konstrukce je 3 m. Délka celého zařízení nesmí přesáhnout 4 m a maximální šířka jednoho pevného panelu nebo zavěšených dveří je 1 m. Maximální výška nosníku – 1 m a délka – 2 m.

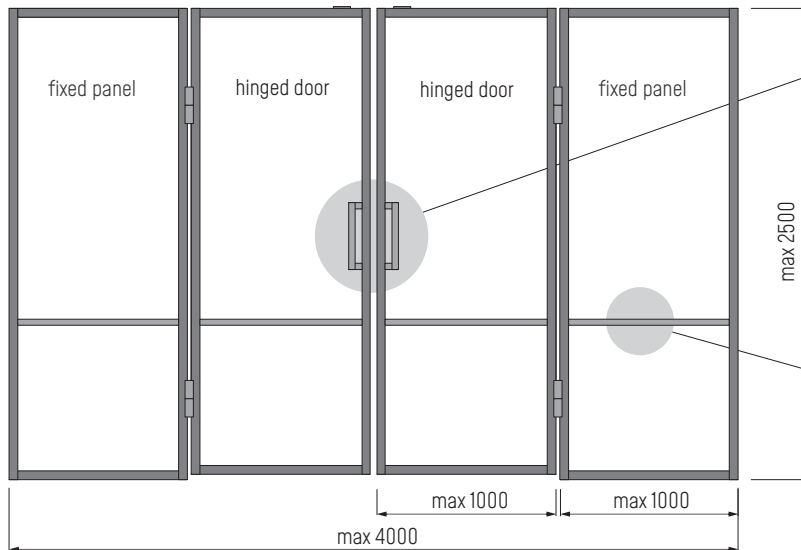
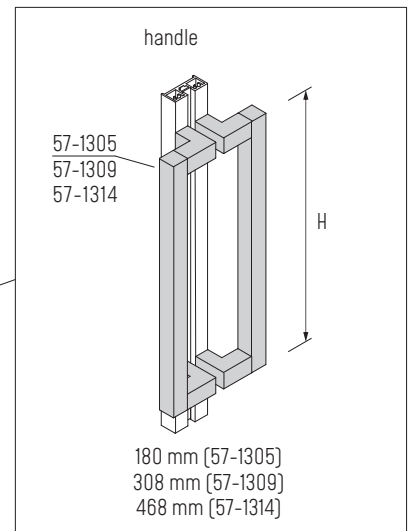
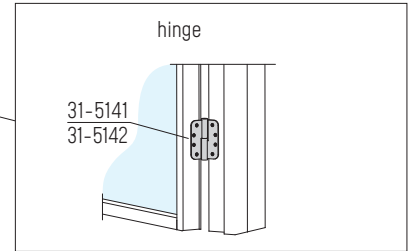
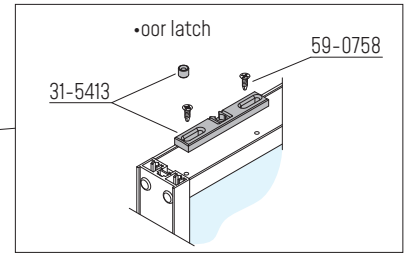
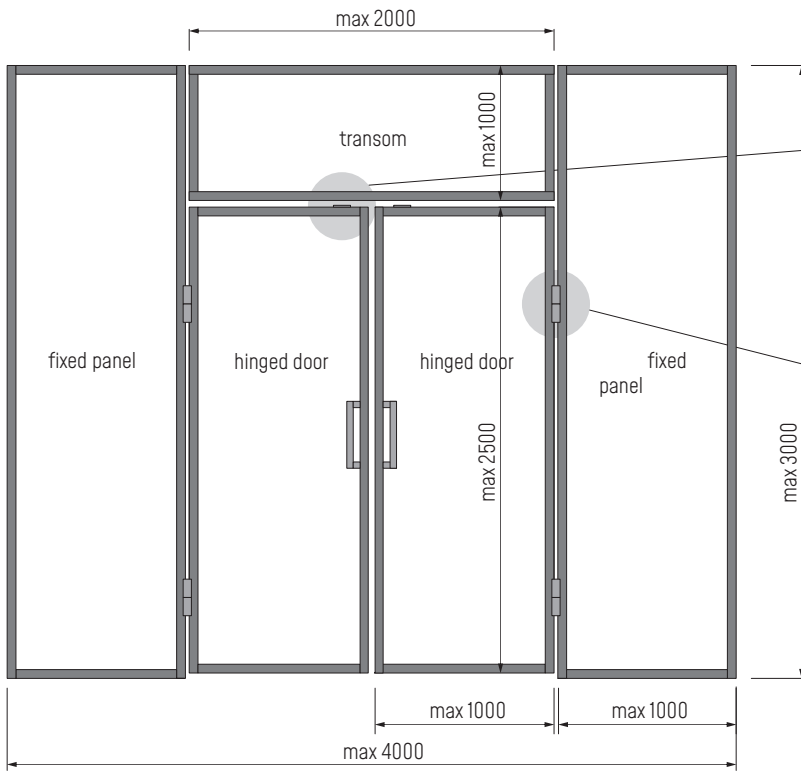

CONFIGURATION EXAMPLES • EXAMPLES OF DIVISIONS AND FILLINGS

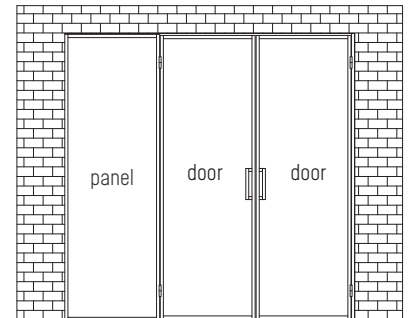
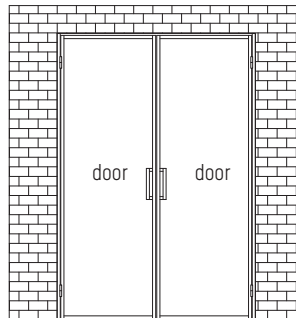
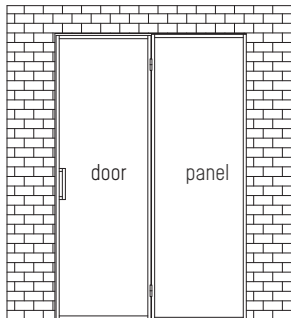
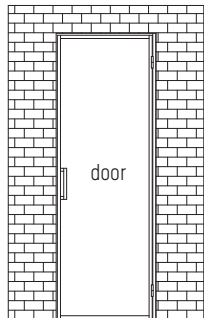
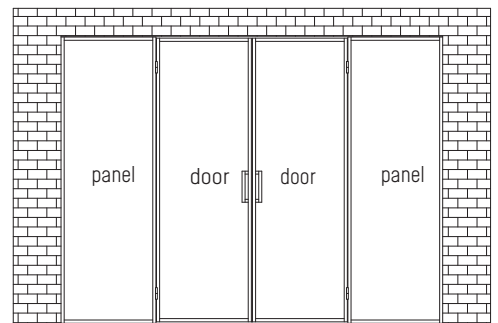
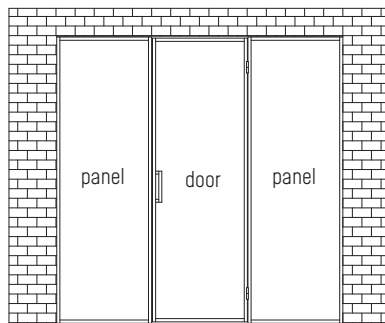
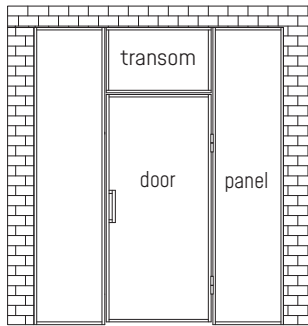
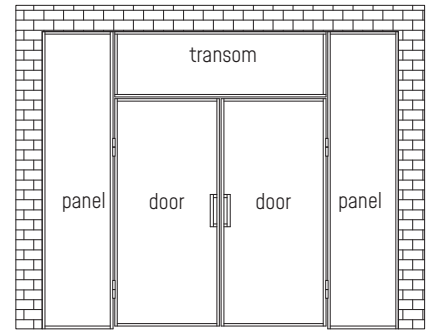
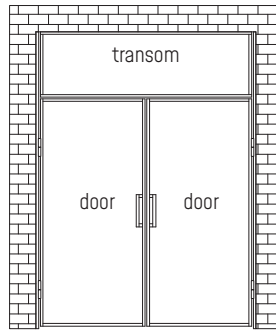
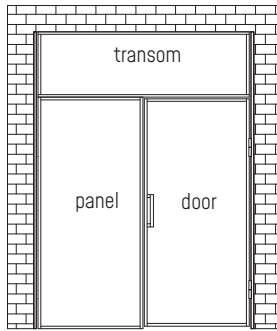
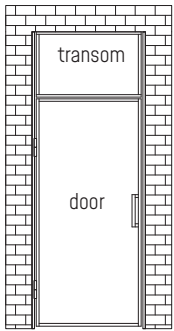

EXAMPLES OF DIVISIONS AND FILLINGS



# TECHNICAL DETAILS

TRANSOM WITH FIXED PANEL

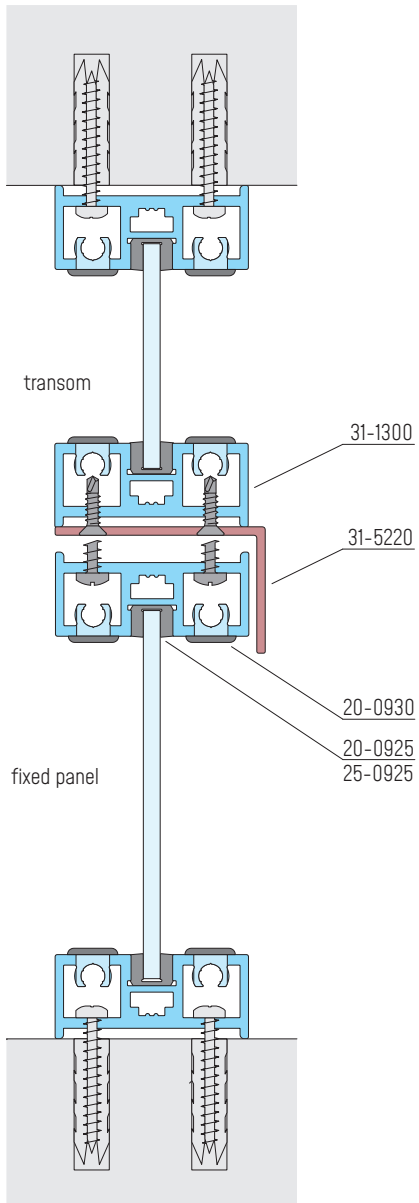

TRANSOM WITH HINGED DOORS

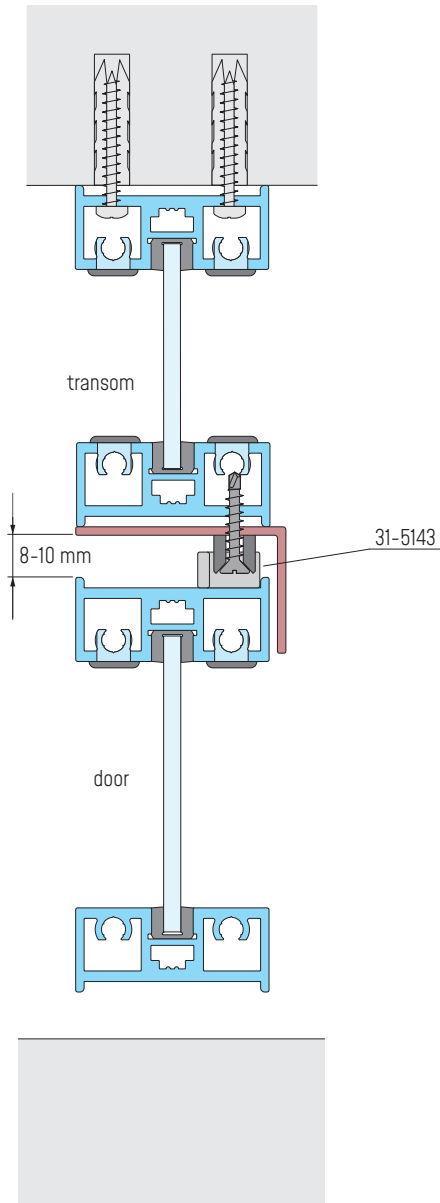

FIXED PANEL

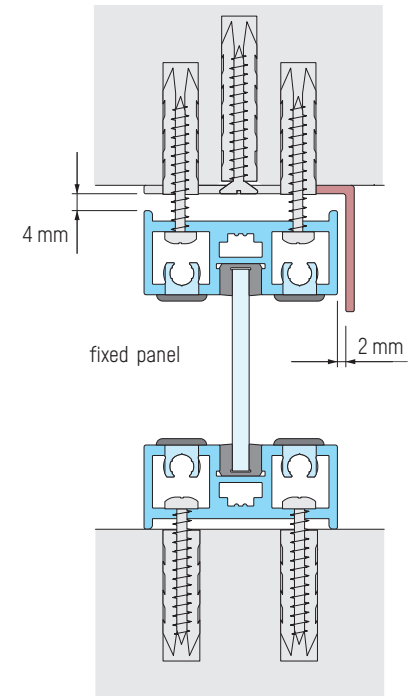

JOINING PROFILES IN THE CORNER

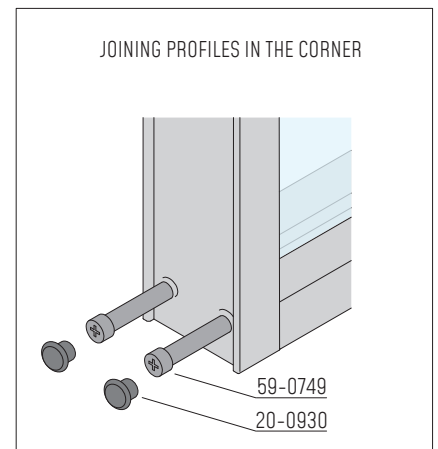

# TECHNICAL DETAILS

## FIXED PANEL ADJUSTMENT OPTION

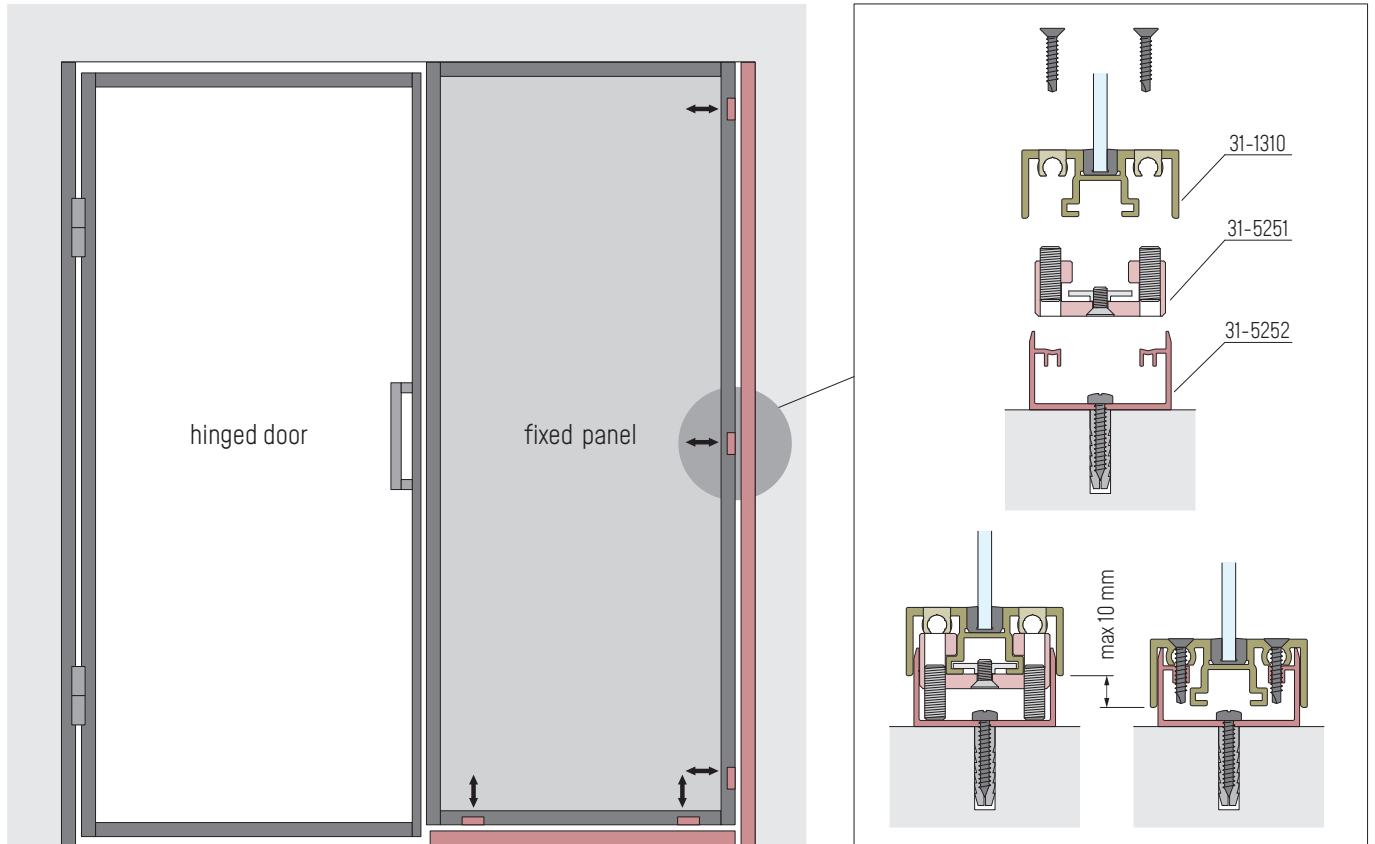

adjustment c-channel bar

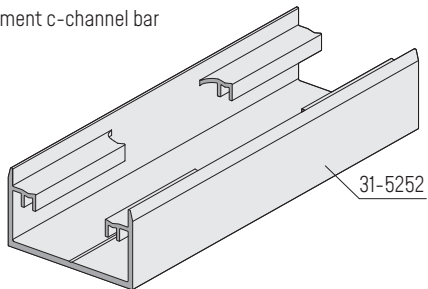

adjustment insert

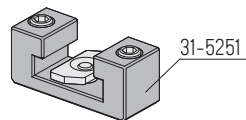

masking plate

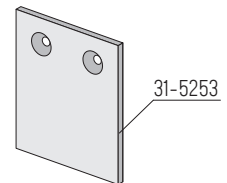

# [ 5 ] SYSTEM COMPONENTS

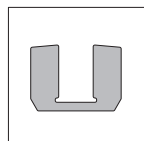

**20-0925**  
GLAZIN STRIP  
CM, PR

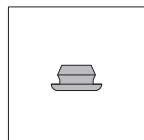

**20-0930**  
KOREK  
PLUG  
AN, CZ

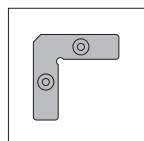

**21-1301**  
SMALL FIXING BRACKET

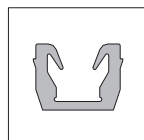

**25-0925**  
AL25 SERIES 4 MM GASKET  
CM, PR

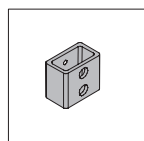

**26-0181**  
AL26 MASKING STRIP HOLDER

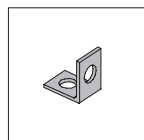

**26-0182**  
AL26 MASKING STRIP  
CATCH

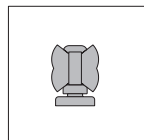

**27-0501**  
AL27 BOTTOM SLIDING GUIDE  
CZ, SZ

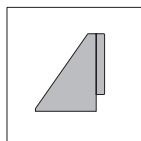

**27-0980**  
AL27 BOTTOM STOPPER  
AN, CM

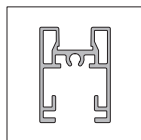

**27-1400**  
AL27 RAIL, 2750 MM  
AN, CM

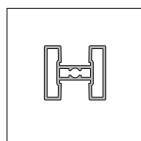

**27-1700**  
AL27 SINGLE DOOR JOINER RAIL, 2750 MM  
AN, CM

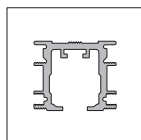

**27-2110**  
AL27-2 TOP TRACK 2, 5000 MM

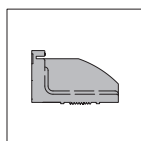

**27-2130**  
AL27-2 ANGLE BRACKET

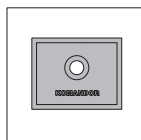

**27-2131**  
AL27-2 SPACER WASHER

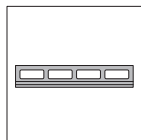

**27-2140**  
AL27-2 SPACER INSERT

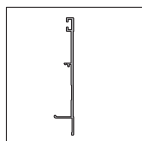

**27-2180**  
AL27-2 CEILING MASKING STRIP, 5000  
MM AN, CM

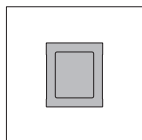

**27-2181**  
AL27-2 CEILING TRACK PLUG  
AN, CM

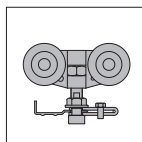

**31-0600**  
LUMI TOP ROLLER

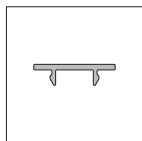

**31-0895**  
AL31 MASKING STRIP 2750 MM  
AN, CM

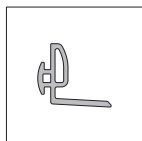

**31-0922**  
AL31 DOOR FRAME GASKET  
CZ, SJ

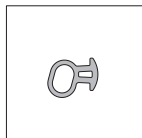

**31-0923**  
AL31 DOOR FRAME CASING GASKET  
CZ, SJ

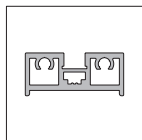

**31-1300**  
AL31 DOOR PROFILE 3050 MM  
AN, CM

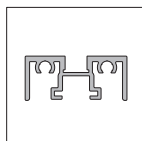

**31-1310**  
AL31 OPEN RAIL 3050MM  
AN, CM

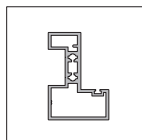

**31-1320**  
AL31 DOOR FRAME 3050 MM  
AN, CM

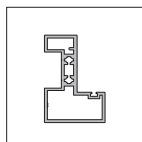

**31-1321**  
AL31 DOOR FRAME 3550 MM  
AN

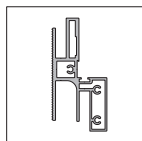

**31-1322**  
AL31 DOOR FRAME 5300  
MM AN, CM

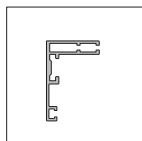

**31-1603**  
AL31 DOOR FRAME CASING 30, 5300  
MM AN, CM

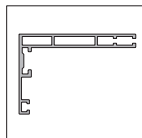

**31-1607**  
AL31 DOOR FRAME CASING 70, 5300  
MM AN, CM

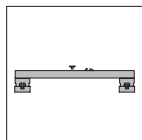

**31-2691**  
LUMI AIR SPRING  
COMPONENTS



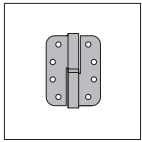

**31-5141**  
AL31 BUTT HINGE, LEFT  
CM, MS

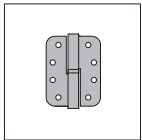

**31-5142**  
AL31 BUTT HINGE, RIGHT  
CM, MS

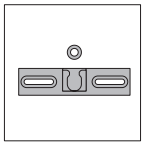

**31-5143**  
LUMI DOOR LATCH

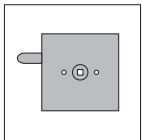

**31-5144L**  
LUMI DOOR LOCK, LEFT  
CM, MS

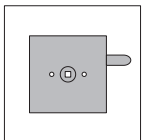

**31-5144P**  
LUMI DOOR LOCK, RIGHT  
CM, MS

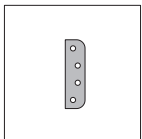

**31-5145**  
BUTT HINGE SPACER  
CM, MS

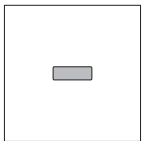

**31-5210**  
LUMI FLAT BAR 12X4x3000 MM  
AN, CM

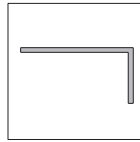

**31-5220**  
LUMI ANGLE 50x25x4000 MM  
AN, CM

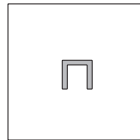

**31-5240**  
LUMI C-CHANNEL BAR 12x12x3000 MM  
AN, CM

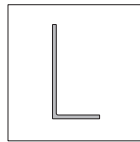

**31-5250**  
LUMI FIXING BRACKET 50x25x2  
AN, CM

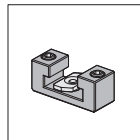

**31-5251**  
LUMI ADJUSTMENT INSERT

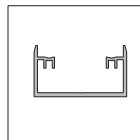

**31-5252**  
LUMI C-CHANNEL BAR FOR ADJUSTMENT 4000 MM  
AN, CM

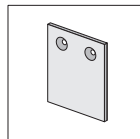

**31-5253**  
MASKING PLATE OF LUMI ADJUSTABLE  
PANEL MS, CM

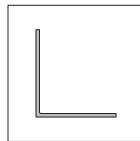

**31-5260**  
LUMI DOOR CASING FIXING BRACKET 60x60x40

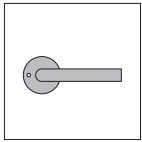

**57-1300**  
LUMI DOOR HANDLE WITH ROUND PLATE  
CM. MS

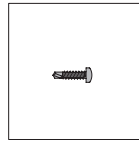

**59-0730**  
CYLINDRICAL HEAD SELF-DRILLING SCREW 3,5x16

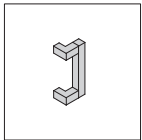

**57-1305**  
LUMI HANDLE 160 MM  
CM. MS

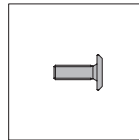

**59-0731**  
SOCKET HEAD SCREW  
M6x18

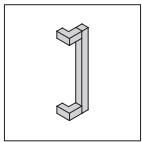

**57-1309**  
LUMI HANDLE 288 MM  
CM. MS

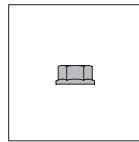

**59-0732**  
SECURING NUT M6

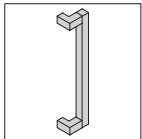

**57-1314**  
LUMI HANDLE 448 MM  
CM. MS

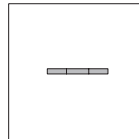

**59-0733**  
6,4 MM PLAIN WASHER

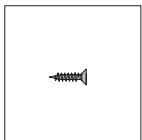

**59-0702**  
MOUNTING SCREW 3,5x16 MM

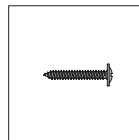

**59-0739**  
SCREW WITH WASHER 3,5x25

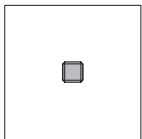

**59-0719**  
HEADLESS SET SCREW M5x5

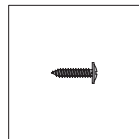

**59-0740**  
SCREW WITH WASHER 3,5x13

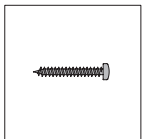

**59-0728**  
MOUNTING SCREW 3,9x38 MM

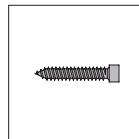

**59-0749**  
MOUNTING SCREW 6,3x35

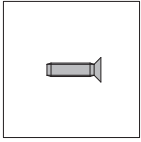

**59-0751**  
COUNTERSUNK HEAD SELF-FORMING SCREW M5x10

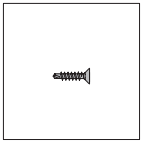

**59-0758**  
COUNTERSUNK SELF DRILLING SCREW 3.5x16

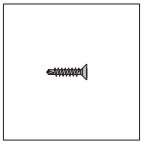

**59-0759**  
COUNTERSUNK SELF DRILLING SCREW 3.5x19

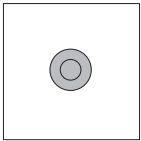

**59-2002**  
SCREW PLUG  
AN, CM