



Distributor pro ČR a SK
www.mintiga.cz
obchod@mintiga.cz
+420 724 124 042

listino prezzi public
price list liste de prix **2022**

Diemme.

INDICE / INDEX / INDEX

- 4 **Condizioni generali di vendita** / General sales conditions / Conditions générales de vente
- 6 **Garanzia** / Warranty / Garantie
- 8 **Certificazioni** / Certifications / Certifications
- 9 **Informazioni generali** / General information / Informations générales

Direzionali

Executive chairs / Fauteuils de direction



ARTÙ
14



AUCKLAND
16



DUKE
19



HALFPIPE
20

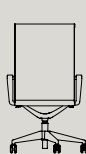

LIBERTY
23



STYLE
25

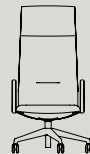

VELVET
26

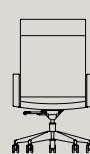

VENUS
28

Operative

Task chairs / Sièges de bureau



BINGO
32



FIT
33



FIVE
37



GOAL
39

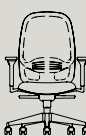

HOP
40

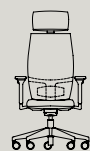

LEAD
41

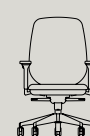

SKIN
43



OBLÒ
46

Collettività

Community / Chaises



HOST
48

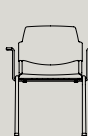

NEW BONN
50



NO FRILL
56



NUKE
57

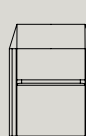

ORIGAMI
58

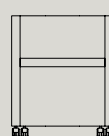

PASS
59



SLIM
60

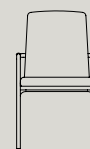

SOCIAL
63



SUNNY NEW
64

Visitatore

Visitor chairs / Chaises visiteur



CHAT
70



CLEA
71



CLEA PLUS
72



CLOP
73



EON
82



LOFT
89



MARGARITA
91



MISS
92



MISTER
97

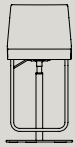

PRINCE
98



REDHOT
99



VANITY
100

Poltrone e divani

Armchairs and sofas / Fauteuils et canapes

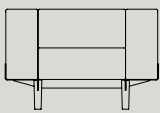

BREAD
102

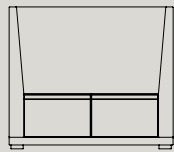

CIRCUIT
105

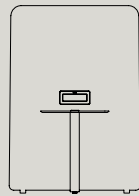

CIRCUIT
MEDIA
110

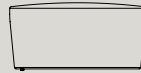

CIRCUIT
POUF
111



CIRCUIT
PRIVÉ
112

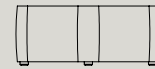

CROSS
113

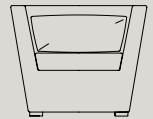

DOUBLE
114

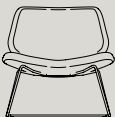

EON
LOUNGE
115

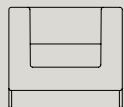

FRAME
116

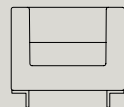

HALL
117

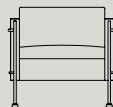

JAZZ
118

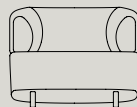

LOFT
119

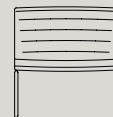

MISS
LOUNGE
120

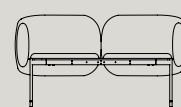

SNAKE
121

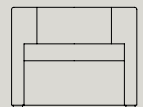

TOFFEE
126

Complementi

Accessories / Accessoires



BREAD
128



CIRCUIT
130



MARGARITA
131

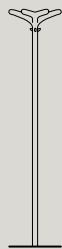

ROCKET
132



SNAKE
133



SNAKE
134



XL - XS
135

Condizioni generali di vendita

1) Prezzi - I prezzi relativi al presente listino sono espressi in EURO e sono al netto dell'IVA. I prezzi di listino potrebbero essere soggetti a variazioni e Diemme Srl si impegna a darne comunicazione.

L'azienda richiede un contributo spese di trasporto pari a € 25,00 per ordini inferiori o uguali a 250,00 € netti, valido solo per il mercato italiano. Le spedizioni effettuate per urgenze particolari, a mezzo corriere espresso, si intendono in porto assegnato.

Per i paesi al di fuori dell'Italia i prezzi sono da considerarsi generalmente ex works.

2) Pagamenti - I pagamenti devono essere effettuati nei termini stabiliti, per eventuali contestazioni l'azienda valuterà, una volta comprovato il danno e la responsabilità di esso, la possibile sospensione del pagamento; i pagamenti non effettuati alla scadenza comporteranno: l'addebito delle spese anticipate alla banca, delle spese originarie di bollatura e per l'incasso, delle spese per l'eventuale protesto, gli interessi di mora calcolati al tasso bancario vigente, e le spese postali.

Le irregolarità e/o mancanze di pagamenti anche parziali ci danno il diritto di sospendere e/o annullare gli ordini in corso, come pure di variare, con preavviso, i termini e i modi dei pagamenti per i successivi ordini.

La merce rimane di proprietà della Diemme Srl fino al pagamento totale della fattura corrispondente.

3) Termini di consegna - Diemme Srl si impegna a rispettare le date e/o tempi di consegna, comunicati per iscritto all'acquirente, e qualora non riuscisse a rispettarli, ne darà tempestivo avviso. È anche stabilito che operano come giustificazioni di eventuali ritardi nella consegna, oltre ai casi di forza maggiore, tutte le cause che comunque possono ritardare il processo di fabbricazione, come ad esempio: agitazioni sindacali, ritardi imputabili ai fornitori, sospensioni di trasporti, deficienza di energia elettrica, incendio, infortuni, ecc. e che non dipendono comunque in modo diretto dal comportamento e dalla volontà di Diemme Srl. La ditta Diemme Srl si riserva il diritto, con preavviso, di evadere gli ordini anche solo parzialmente e/o sospendere il completamento degli ordini già parzialmente evasi.

4) Trasporti - Con il ritiro della merce da parte dell'Acquirente o di persona da lui appositamente incaricata in tal senso, Diemme Srl ritiene assolta ogni sua obbligazione. Eventuali reclami devono essere comunicati per iscritto entro 8 giorni dal ricevimento della merce. Le contestazioni per danni derivanti dal trasporto devono essere fatte al Vettore al momento dello scarico.

5) Resa merce - I materiali dovranno pervenirci solo dopo nostra preventiva autorizzazione, opportunamente imballati e in porto franco. La merce resa con nostra autorizzazione sarà accreditata solo se in perfette condizioni, per eventuali danni causati da incuria del cliente, saranno addebitate le spese di ripristino dei beni oltre ad eventuali spese generali di gestione.

6) Modifiche produttive - La ditta venditrice Diemme Srl si riserva la possibilità di modificare il prodotto, nelle dimensioni, nell'estetica e nei materiali in qualsiasi momento, allo scopo di migliorarne la qualità e la funzionalità.

Leggere differenze di tonalità di colore nei rivestimenti rispetto a quelli contenuti nella "cartella rivestimenti" sono da considerarsi normali e non potranno dar luogo a richieste di sostituzione o danni.

7) Foro competente - Per ogni controversia il foro competente è esclusivamente TREVISO.

8) Materiale pubblicitario - Il materiale pubblicitario, il catalogo e il campionario dei tessuti consegnati rimangono di proprietà della ditta Diemme Srl, la quale ha la facoltà di ritirarli in qualsiasi momento.

IL PRESENTE LISTINO ANNULLA E SOSTITUISCE TUTTI I PRECEDENTI.

General sales conditions

1) Prices - Prices in this Price List are in EUROS and exclude VAT. List prices may be subject to variations and Diemme (henceforth Diemme) will communicate these with due notice.

Prices are considered ex works. For further details, contact the area manager or the company itself.

2) Payment - Payments must be made as per the agreed terms; in the case of any complaint, the company will analyse the circumstances and evaluate any possible suspension of payment. Failure to settle an invoice at its expiry will lead to Diemme charging all extra costs incurred, including any extra bank or postal charges; the cost will be calculated according to the bank rates in force. In case of irregularity or delay in payments, Diemme has the right to suspend or cancel all orders as well as to change the sales conditions.

Goods remain the property of Diemme until total payment of the relative invoice has been made.

3) Delivery time - Diemme srl is committed to respecting any dates and/or delivery times as communicated in writing to the purchaser, and if Diemme cannot respect them, it will inform the customer immediately. Justifiable manufacturing delays may be attributable to force majeure, or causes including: strikes, delays in the supply chain, transport suspensions, electricity problems, fires, accidents, etc. and anything that does not depend directly on Diemme's performance and good will.

Diemme reserves the right, by giving notice, to fulfil orders only partially and/or to suspend completion of already partially fulfilled orders.

4) Transportation - Upon loading of goods by the purchaser or by a third party duly appointed by the purchaser, Diemme becomes free from any obligations. Notification of damage due to transportation must be communicated in written format on the delivery note to the carrier at the moment of unloading. Any other complaints must be made in writing to Diemme within 8 days of goods receipt.

5) Returns - Goods may be returned only with Diemme's prior written authorisation. Carriage is to be paid by the purchaser, and goods appropriately packed. Such goods returned with Diemme's authorisation will be credited only if in perfect condition; for damages caused by customer negligence, Diemme reserves the right to charge for repair and administration costs.

6) Modifications - To improve its products Diemme Srl reserves the right to modify dimensions, appearance, and materials at any time with the aim of improving quality and functionality. Slight colour differences in upholstery those in the fabric folder are to be considered normal and will not justify complaints, replacements, or damages.

7) Disputes - For any disputes, the Treviso Court will be the place of jurisdiction.

8) Advertising Material - All advertising material, catalogues and material samples supplied remain the property of Diemme. Diemme reserves the right to withdraw these at any time.

THIS PRESENT PRICE LIST CANCELS AND REPLACES ALL PREVIOUS.

Conditions générales de vente

1) Prix - Les prix relatifs à ce tarif sont exprimés en EURO et HT. Les prix indiqués peuvent être sujets à changement et Diemme Srl s'engage à le communiquer. Pour les conditions de franco / frais de port, contactez avec le réfèrent ou l'usine.

2) Paiements - Les paiements doivent être effectués dans les délais impartis, pour tout litige la société évaluera, une fois le dommage et la responsabilité avérés, l'éventuelle suspension du paiement; les paiements non effectués à l'échéance entraîneront: les frais bancaires, les frais de timbre et de collection, les frais de réclamation, les intérêts de retard calculés au taux bancaire en vigueur et les frais de port. Les irrégularités et/ou le défaut de paiement, même partiel, nous donnent le droit de suspendre et/ou d'annuler les commandes en cours, ainsi que de modifier, avec préavis, les conditions et modalités de paiement des commandes ultérieures.

Les marchandises restent la propriété de Diemme Srl jusqu'au paiement intégral de la facture correspondante.

3) Conditions de livraison - Diemme Srl s'engage à respecter les dates et/ou heures de livraison, communiquées par écrit à l'acheteur, et en cas de non-respect de celles-ci, il en informera sans délai. Il est également établi que, outre les cas de force majeure, toutes les causes pouvant en tout état de cause retarder le processus de fabrication, telles que: troubles syndicaux, retards imputables aux fournisseurs, suspensions de transport, carence d'électricité, incendie, accidents, etc. et qui ne dépendent cependant pas directement du comportement et de la volonté de Diemme Srl.

Diemme Srl se réserve le droit, avec préavis, d'exécuter même partiellement les commandes et/ou de suspendre l'exécution des commandes déjà partiellement exécutées.

4) Transport - Avec le retrait des marchandises par l'Acheteur ou par une personne spécifiquement désignée par lui pour le faire, Diemme Srl considère que toutes ses obligations sont remplies. Toute réclamation doit être communiquée par écrit dans les 8 jours suivant la réception de la marchandise. Les litiges pour dommages résultant du transport doivent être adressés au Transporteur au moment du déchargement.

5) Retour produits - Les matériaux ne doivent nous parvenir qu'après notre autorisation préalable, correctement emballés et port payé. Les marchandises retournées avec notre autorisation ne seront créditées que si elles sont en parfait état, pour tout dommage causé par la négligence du client, les frais de restauration des marchandises seront facturés en sus des éventuels frais de gestion générale.

6) Modification technique du produit - La société de vente Diemme Srl se réserve le droit de modifier le produit, en termes de taille, d'esthétique et de matériaux à tout moment, afin d'améliorer sa qualité et sa fonctionnalité.

De légères différences de teintes des revêtements par rapport à celles contenues dans la "collection échantillons revêtements" sont à considérer comme normales et ne peuvent donner lieu à des demandes de remplacement ou de détérioration.

7) Juridiction - Pour tout litige, le tribunal compétent est exclusivement celui de TREVISO.

8) Support publicitaire - Le matériel publicitaire, le catalogue et les échantillons des tissus livrés restent la propriété de la société Diemme Srl, qui a le droit de les retirer à tout moment.

CETTE LISTE ANNULE ET REMPLACE TOUTES LES PRÉCÉDENTS.

CERTIFICAZIONI
CERTIFICATIONS / CERTIFICATIONS



Direzionali / Executive chairs / Fauteuils de direction	ARTÙ	•	•			•						
	AUCKLAND	•	•			•	•	•				•
	DUKE	•	•	•								
	HALFPIPE	•	•			•	•	•		•		
	LIBERTY	•				•	•	•				
	STYLE	•				•						
	VELVET	•				•						
	VENUS	•				•						
Operative / Task chairs / Sièges de bureau	BINGO	•	•		•							
	FIT MESH/POLY	•	•	•	•		•	•	•			
	FIT UP	•	•	•	•		•	•	•			
	FIVE	•	•		•		•	•				•
	GOAL	•	•		•							•
	HOP	•	•		•		•	•				
	LEAD	•	•	•								•
	SKIN	•	•		•		•	•				•
	OBLÒ	•										
Collettività / Community / Chaises de collectivité	HOST <i>in corso / ongoing</i>	•					•	•		•		
	NEW BONN	•					•	•		•		•
	NO FRILL	•								•		
	NUKE									•		
	ORIGAMI	•										
	PASS	•										
	SLIM	•					•	•	•		•	
	SOCIAL	•										
	SUNNY NEW	•					•	•		•		
Visitatore / Visitor chairs / Chaises visiteur	CHAT	•										
	CLEA / CLEA PLUS	•										
	CLOP	•	•		•		•	•		•		•
	EON	•					•				•	
	LOFT <i>in corso / ongoing</i>	•										
	MARGARITA	•					•					
	MISS	•					•			•		
	MISTER	•										
	PRINCE	•										
	REDHOT											
	VANITY	•										

CERTIFICAZIONI
CERTIFICATIONS / CERTIFICATIONS

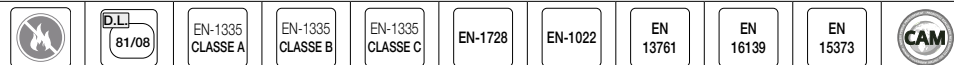

Poltrone e divani / Armchairs and sofas / Fauteuils e canapés	BREAD	●										
	CIRCUIT	●					Ansi Bifma					
	CROSS	●					●					
	DOUBLE	●										
	EON LOUNGE	●										
	FRAME	●										
	HALL	●										
	JAZZ	●										
	LOFT	●										
	MISS LOUNGE	●										
	SNAKE	●						●	●		●	
	TOFFEE	●										
Complementi / Accessories / Accessoires	BREAD											
	CIRCUIT											
	MARGARITA											
	ROCKET											
	SNAKE											
	XL - XS											



Omologazione ministeriale in classe 11M
Fireproof Italian Ministry homologation in 11M class
Certification italienne contre le feu en classe 11M

EN 13761

Requisiti per sedie visitatori
Requirements for visitor chairs
Exigences pour les chaises visiteurs



Conforme ai requisiti richiesti da D.L. n. 81 del 09/04/2008
Complies requirements of D.L. n. 81 del 09/04/2008
Conforme à D.L. n° 81 du 09/04/2008

EN 16139

Requisiti per sedie visitatori
Requirements for visitor chairs
Exigences pour les chaises visiteurs

EN-1335

Requisiti per sedie da lavoro per ufficio
Requirements for office chairs
Exigences pour les chaises de travail

EN 15373

Requisiti per sedute non domestiche
Requirements for non-domestic chairs
Exigences pour les chaises non domestiques

EN-1728

Determinazione della resistenza e della durabilità
Determination of strength and durability
Détermination de la résistance et de la durabilité



Criteria ambientali minimi
Environmental requirements as per Italian law
Critères environnementaux selon la loi italienne

EN-1022

Determinazione della stabilità
Determination of stability
Détermination de la stabilité



UNI EN
ISO 9001

Garanzia

Tutti i prodotti di Diemme srl sono garantiti per 5 anni dalla data di acquisto o di consegna su tutte le parti meccaniche difettose, considerato un uso corretto e standard del prodotto (8 ore giornaliere per 5 giorni alla settimana).

Diemme srl garantisce la buona qualità e la buona costruzione dei prodotti venduti. La presente garanzia copre la riparazione o la sostituzione delle parti che risultino difettose per cause imputabili alla fabbricazione, mentre non copre:

- i rivestimenti.
- danni causati dal trasporto
- danni dovuti a calamità naturali
- danni dovuti a negligenza o trascuratezza nell'uso
- danni dovuti all'errata installazione e non corretta manutenzione
- danni relativi alla naturale usura del bene.

Eventuali difetti, mancanza di qualità promessa o vizi palesi dei prodotti forniti, devono essere comunicati, a pena di decadenza, per iscritto alla Diemme srl entro e non oltre 2 mesi dal ricevimento dei prodotti.

Resta inteso che l'acquirente si impegna, a pena di decadenza dei diritti derivanti dalla presente, a verificare l'eventuale presenza di difetti, mancanza di qualità promessa o vizi su tutti i prodotti consegnati, anche se tali sono numerosi e/o contenuti in cartoni o altri contenitori; in caso contrario i diritti derivanti dalle condizioni della presente garanzia verranno meno.

La sola responsabilità in capo a Diemme srl consiste nella sostituzione o riparazione dei prodotti difettosi.

Ogni discrepanza sullo stato o numero dei prodotti trovata nel corso dello scarico della merce a destino deve essere immediatamente segnalata nei documenti di trasporto e controfirmata dal trasportatore per accettazione.

Warranty

All Diemme srl products are guaranteed in all their mechanical parts for 5 years from the purchasing or delivery date, considering a correct and standard use of the product (8 hours per day for 5 days a week).

Diemme srl guarantees that its products are well manufactured and of good quality.

The present warranty guarantees the repair or replacement of products or parts thereof due to manufacturing faults, while it does not cover:

- upholsteries
- transport damages
- damage due to natural disasters
- damage due to misuse,
- faulty installation or inadequate maintenance
- natural wear and tear.

Faults, lack of promised quality or apparent damage to the products supplied must be communicated to Diemme srl in writing by the customer within two (2) months from the receipt of the products, otherwise Diemme srl will not be responsible for them.

It is understood that the buyer undertakes, under penalty of forfeiture of the rights deriving from this warranty, to check for any defects, lack of promised quality or faults on all products delivered, even if these are numerous and/or contained in cartons or other containers; otherwise, the rights deriving from the conditions of this guarantee will cease.

The sole responsibility of Diemme srl consists in the replacement or repair of any defective products or parts.

Any discrepancy on the condition or number of products found during unloading of the goods at their destination must be reported immediately on the transport documents and countersigned by the carrier for acceptance.

Garantie

Tous les produits Diemme srl sont garantis 5 ans à compter de la date d'achat ou de livraison sur toutes les pièces mécaniques défectueuses, considérées comme une utilisation correcte et standard du produit (8 heures par jour pendant 5 jours par semaine).

Diemme srl garantit la bonne qualité et la bonne construction des produits vendus. Cette garantie couvre la réparation ou le remplacement de pièces défectueuses pour des raisons imputables à la fabrication, alors qu'elle ne couvre pas:

- les revêtements.
- dommages causés par le transport
- dommages dus à des catastrophes naturelles
- dommages dus à la négligence ou à la négligence de l'utilisation
- dommages dus à une mauvaise installation et un mauvais entretien
- dommages liés à l'usure naturelle du bien.

Tout défaut, absence de qualité promise ou défauts évidents des produits fournis, doit être communiqué, sous peine de déchéance, par écrit à Diemme srl au plus tard 2 mois après réception des produits.

Il est entendu que l'acheteur s'engage, sous peine de déchéance des droits qui en découlent, à rechercher d'éventuels défauts, défauts de qualité promise ou défauts sur tous les produits livrés, même s'ils sont nombreux et/ou contenus dans cartons ou autres contenants; dans le cas contraire, les droits découlant des conditions de cette garantie cesseront.

La seule responsabilité de Diemme srl consiste dans le remplacement ou la réparation des produits défectueux.

Toute divergence sur le statut ou le nombre de produits trouvés lors du déchargement des marchandises vers leur destination doit être immédiatement signalée dans les documents de transport et contresignée par le transporteur pour acceptation.

Informazioni Generali

Ordini e consegne

Diemme srl raccomanda la gentile clientela di inviare gli ordini, completi di dati anagrafici della società, indicando chiaramente il codice del prodotto, il rivestimento scelto, la quantità, il luogo di destinazione con eventuali informazioni di contatto (telefono e giorni/orari di scarico merce) e dettagli, se importanti, della zona di accesso o ancora della data desiderata di consegna.

La merce è resa franco sponda camion, con veicoli standard. Qualora si necessitasse di servizi extra (es. sponda idraulica, transpallet, facchinaggio al piano) saranno da richiedere al momento dell'ordine e, se disponibili, verranno fatturati al costo.

Tessuti forniti dai clienti

Prezzo di riferimento per prodotti rivestiti con tessuti inviati dal cliente: categoria F.

Vi preghiamo di inviare sempre il metraggio accompagnato da un documento di trasporto con i riferimenti dell'ordine e nominativo del cliente.

Diemme srl è disponibile a rivestire i suoi prodotti con tessuti, ecopelli e pelli forniti dal cliente, riservandosi tuttavia il diritto di riserva e di approvazione di produzione. I materiali devono essere consegnati franco nostra sede.

Il metraggio necessario è indicato nel listino come nota a piè di pagina per ciascun prodotto e fa riferimento ad 1 pezzo. Qualora si tratti di quantità importanti, consigliamo di fare richiesta esplicita del metraggio totale necessario all'azienda.

Diemme srl è inoltre disponibile ad acquistare rivestimenti "fuori catalogo" e verrà comunicata la categoria o il prezzo di riferimento del prodotto richiesto con la finitura scelta.

Scheda prodotto

Le schede prodotto sono disponibili nel sito web all'indirizzo www.diemmeoffice.com e ottemperano le disposizioni del decreto legislativo 6 settembre 2005 n. 206 "Codice del consumo".

Imballo e Montaggio

La merce di Diemme srl viene imballata accuratamente in scatole di cartone e protetta internamente da nylon.

Se il cliente richiede un imballo diverso (es. merce su pallet) Diemme srl si riserva il diritto di addebitare in fattura i relativi costi. Qualora invece sia Diemme srl ad optare per un imballaggio differente, i costi saranno a carico dell'azienda.

I pesi e i volumi indicati nel listino si riferiscono al prodotto singolo di riferimento. Si tratta di dati indicativi in quanto possono variare a seconda degli optional o varianti del prodotto, oppure ancora se si riesce ad ottimizzare l'imballo includendo più pezzi per scatola. Per informazioni in merito, rivolgersi direttamente all'azienda.

I prodotti Diemme vengono spediti nella maggior parte premontati, se non ci sono diversi accordi tra le parti, ovvero non è necessario usare degli strumenti per assemblarli. In alcuni modelli sarà necessario utilizzare un semplice cacciavite o chiave esagonale facilmente reperibili. Le istruzioni di montaggio viaggiano con il manufatto e Diemme srl resta disponibile per eventuali chiarimenti in merito.

Se il cliente richiede il prodotto completamente montato, verrà comunicato il costo aggiuntivo, anche del relativo trasporto ed applicato in fattura.

È auspicabile che il cliente ponga sempre la riserva in bolla al momento della ricezione della merce per tutelarsi da eventuali danni causati dal trasporto e avvalersi dell'assicurazione di quest'ultimo.

General Information

Orders and deliveries

Diemme requires customers to send orders, complete with company data, clearly indicating product codes, the upholstery chosen, the quantity, and the name of the appointed transporter. In cases where Diemme Srl arranges the transport, customers should additionally state the delivery point with contact person's name and phone number, along with unloading days and times, and any important access details or restrictions related to the time or place of delivery.

Goods are supplied to the tail-lift of the truck, considering standard vehicles. For any specific or extra delivery requirements, including delivery beyond truck or the use of special equipment, please contact Diemme Srl with plenty of notice and, if possible, these will be charged and invoiced at cost.

Tessuti forniti dai clienti

Use the price in **Category F** when sending customer's own material or leather.

Please send always your materials accompanied by a delivery note (stating the order reference and the customer name) or by the Diemme Fabric Tracking label which you can require to the company.

Diemme srl agrees to upholster products in customer-supplied fabrics, faux leathers or genuine leathers, always reserving the right of approval of such materials for manufacturing suitability. Such upholstery materials are to be delivered carriage paid to the Diemme Srl warehouse. Required meterage is indicated in the price list, at the bottom of each product page, and refer to single pieces. For contract quantities please ask for the revised requirements.

Diemme srl may also purchase upholsteries not included in the standard Diemme collection, and according to the product and finish selected, the customer will be informed of the price or applicable price category.

Product information

Product sheets are available on the website www.diemmeoffice.com and are in conformity with decree number 206 dated 6th September 2005 "Consumer rules and regulations".

Packaging and Assembly

Diemme goods are well packed in cardboard boxes with internal nylon wrapping.

If the customer requires different packaging (for example goods on pallet) Diemme reserves the right to charge for the related costs on the invoice. However, if it is Diemme that chooses a different way of packing, such expenses are borne by Diemme.

The weights and volumes shown in the price list refer to single items. They are approximate since they may change due to included accessories, or in cases where it is possible to optimise the packaging by including more than one piece per box. Please enquire for information regarding the total volume or any packing details.

Diemme products are shipped pre-assembled, if there are no other agreements between the parties. No specific tools are needed for assembly. A few models require the use of a simple screwdriver or widely available Allen keys. Assembly instructions accompany the goods and Diemme is available for any further information.

If the customer requires a non-assembled item to arrive fully assembled, any additional cost will be advised.

Customers should always write on the delivery document at goods receipt that "goods are unchecked", thereby guarding against any damages caused by the transport company and being able to claim against the transporter's insurance.

Informations Générales

Commandes et livraisons

Diemme srl recommande aux clients d'avoir l'amabilité d'envoyer les commandes, avec les données personnelles de l'entreprise, en indiquant clairement le code du produit, le revêtement choisi, la quantité, le lieu de destination avec toutes les coordonnées (téléphone et jours / heures de déchargement des marchandises) et les détails, le cas échéant, de la zone d'accès ou de la date de livraison souhaitée. Les marchandises sont livrées hors camion, avec des véhicules standard. Si des services supplémentaires sont nécessaires (par exemple ascenseur hydraulique, transpalette, portage au sol), ils seront demandés au moment de la commande et, si disponibles, seront facturés au prix coûtant.

Tissus fournis par les clients

Prix de référence à considérer pour les produits avec tissus envoyée par le client: **catégorie F.**

Le métrage il y a qu'être envoyé avec un bon de livraison avec la référence de la commande et de le client.

Diemme srl est disponible pour couvrir ses produits avec des tissus, des éco-cuirs et des cuirs fournis par le client, mais en se réservant le droit de réserve et l'approbation de la production. Les matériaux doivent être livrés franco usine de Diemme srl.

Le métrage requis est indiqué dans la liste de prix comme une note en bas de page pour chaque produit et se réfère à 1 pièce. Dans le cas de grandes quantités, nous recommandons de faire une demande explicite pour le nombre total de mètres requis par la société.

Diemme srl est également disponible pour acheter des revêtements "hors catalogue" et la catégorie ou le prix de référence du produit demandé avec la finition choisie seront communiqués.

Fiche du produit

Les fiches produits sont disponibles sur le site Internet www.diemmeoffice.com et sont conformes aux dispositions du décret législatif 6 septembre 2005 n. 206 "Code de la consommation".

Emballage et assemblage

Les marchandises de Diemme srl sont soigneusement emballées dans des boîtes en carton et protégées à l'intérieur par du nylon.

Si le client demande un emballage différent (par exemple des marchandises sur des palettes), Diemme srl se réserve le droit de facturer les frais relatifs sur la facture. Si, en revanche, Diemme srl opte pour un emballage différent, les frais seront à la charge de l'entreprise.

Les poids et volumes indiqués dans la liste de prix se réfèrent au produit de référence unique. Ce sont des données indicatives car elles peuvent varier selon les options ou variantes du produit, ou même si l'emballage peut être optimisé en incluant plus de pièces par boîte. Pour plus d'informations à ce sujet, contactez directement l'entreprise.

Les produits Diemme sont expédiés principalement pré-assemblés, s'il n'y a pas d'accords différents entre les parties, c'est-à-dire qu'il n'est pas nécessaire d'utiliser des outils pour les assembler. Dans certains modèles, il sera nécessaire d'utiliser un simple tournevis ou une clé hexagonale facilement disponible. Les instructions de montage voyagent avec le produit et Diemme srl reste disponible pour toutes clarifications.

Si le client demande le produit entièrement assemblé, le coût supplémentaire sera communiqué, y compris le transport relatif et appliqué sur la facture.

Il est souhaitable que le client place toujours la réserve à la livraison à réception de la marchandise pour se protéger des éventuels dommages causés par le transport et bénéficier de l'assurance de ce dernier.

Ricambi

Spare parts / Pièces de rechange

Prezzi Unitari / Unit Price / Prix unitaire

Kit 5 ruote gommata Kit 5 castors kit 5 roulettes sol dur		€ 27
Kit 5 ruote nere libere per moquette Kit 5 castors free for moquette kit 5 roulettes pour moquette		€ 19
Pistone a gas nero Black gaslift vérin gaz noir		€ 19
Pistone a gas cromato Chromed gaslift vérin chromé		€ 23
Piastra a gas Gas plate plaque pour elevation gaz		€ 19
Meccanismo sincron Synchro mechanism mécanisme synchrone		€ 69
Meccanismo knee-tilt Tilt mechanism mécanisme knee-tilt		€ 64
Tessuto/similpelle cat. F Cat. F fabric/artificial leather Cat F tissu/similicuir	ml	€ 42
Tessuto/similpelle cat. G Cat. G fabric/artificial leather Cat G tissu/similicuir	ml	€ 55
Tessuto/similpelle cat. S Cat. S fabric/artificial leather Cat S tissu/similicuir	ml	€ 80
Tessuto/similpelle cat. Top Cat. Top fabric/artificial leather Cat Top tissu/similicuir	ml	€ 90
Tessuto/similpelle cat. Extra Cat. Extra fabric/artificial leather Cat Extra tissu/similicuir	ml	€ 117

“Design e progettazione si aprono a nuove prospettive su ciò che può essere uno spazio ufficio, dove le persone si possano sentire comode e libere, proprio come a casa loro. Creare lo spazio di lavoro del futuro attraverso il design e il comfort, è parte della nostra filosofia.”

Direzionali

Executive chairs / fauteuils de direction



ARTÙ
14

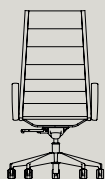

AUCKLAND
16



DUKE
19



HALFPIPE
20

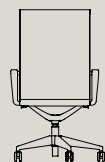

LIBERTY
23



STYLE
25

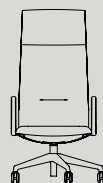

VELVET
26

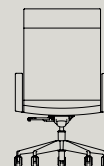

VENUS
28

“Design and planning open up new perspectives on what an office space can be, where people can feel comfortable and free, just like at home. Creating the workspace of the future through design and comfort is part of our philosophy.”

- **Imbottitura in poliuretano espanso**
Polyurethane foam padding
Rembourrage en mousse de polyuréthane
- **Scocca in multistrato curvato**
Shell in multilayer beech wood
Coque en bois multiples

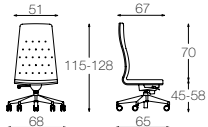
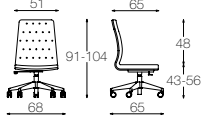
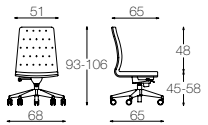
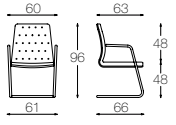
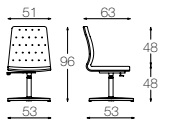
	Cat. F	Cat. G	Cat. S	Cat. TOP	Cat. EXTRA	Pelle Leather Cuir FIESTA	Pelle Leather Cuir NUVOLA	mc	kg
<p>SCHIENALE ALTO, base alluminio, regolazione gas knee-tilt HIGH BACKREST, aluminum base, regulation gaslift knee-tilt DOSSIER HAUT, piètement en aluminium, regulation gaz knee-tilt</p> <p>ARAKAL01 Senza braccioli Without arms Sans accoudoirs</p> 	563	576	642	652	702	833	929	0.34	20.1
<p>SCHIENALE MEDIO, base alluminio, regolazione gas piastra MEDIUM BACKREST, aluminum base, regulation gaslift DOSSIER MOYEN, piètement en aluminium, regulation gaz</p> <p>ARMPAL01 Senza braccioli Without arms Sans accoudoirs</p> 	457	468	524	532	572	704	788	0.32	13.75
<p>SCHIENALE MEDIO, base alluminio, regolazione gas knee-tilt MEDIUM BACKREST, aluminum base, regulation gaslift knee-tilt DOSSIER MOYEN, piètement en aluminium, regulation gaz knee-tilt</p> <p>ARMKAL01 Senza braccioli Without arms Sans accoudoirs</p> 	506	518	571	579	619	752	837	0.32	14.75
<p>SCHIENALE MEDIO, telaio slitta cromato MEDIUM BACKREST, chromed cantilever frame DOSSIER MOYEN, piètement luge chromé</p> <p>ARMCCR11 Con braccioli fissi With arms Avec accoudoirs</p> 	523	534	590	597	638	770	854	0.48	19.1
<p>SCHIENALE MEDIO, telaio 4 razze girevole in alluminio altezza fissa MEDIUM BACKREST, swivel 4 star aluminium frame fixed height DOSSIER MOYEN, piètement pivotant 4 branches aluminium, hauteur fixe</p> <p>ARMTAL01 Senza braccioli Without arms Sans accoudoirs</p> 	549	561	615	623	663	793	875	0.32	18.75

- **Imbottitura in poliuretano espanso**
Polyurethane foam padding
Rembourrage en mousse de polyuréthane
- **Scocca in multistrato curvato**
Shell in multilayer beech wood
Coque en bois multiplis

Accessori / Accessories / Accessoires	Prezzo unitario € Unit price € Prix Unitaire €
<p>Colonna autoallineante per base 4 lame Return mechanism for 4 blades frame Mécanisme de retour sur piètement 4 branches</p>	64

Accessori / Accessories / Accessoires	Cat. F	Cat. G	Cat. S	Cat. TOP	Cat. EXTRA	Pelle Leather Cuir FIESTA	Pelle Leather Cuir NUVOLA
<p>QUBRIM Coppia braccioli imbottiti e rivestiti Padded and upholstered pair of armrests Pair d'accoudoirs rembourrés et revêtus</p> 	246	250	272	276	292	318	357

Consumi schienale alto tessuto / High back fabric consumption / Tissu nécessaire dossier haut **ml 2,00**

Consumi schienale alto pelle / High back leather consumption / Cuir nécessaire dossier haut **mq 3,30**

Consumi schienale medio tessuto / Medium back fabric consumption / Tissu nécessaire dossier moyen **ml 1,70**

Consumi schienale medio pelle / Medium back leather consumption / Cuir nécessaire dossier moyen **mq 3,10**

Consumi braccioli tessuto / Arms fabric consumption / Tissu nécessaire accoudoirs **ml 0,80**

Consumi braccioli pelle / Arms leather consumption / Cuir nécessaire accoudoirs **mq 1,2**



Omologazione ministeriale al fuoco in classe 1IM con rivestimento PLANET o BINGO ELAST / MIRAGE e poliuretano ignifugo (+6% da listino)

Fireproof Italian Ministry homologation in 1IM class with upholstery PLANET or BINGO ELAST / MIRAGE and fire retardant polyurethane (+6% to price list)

Certification Italienne contre le feu en classe 1IM avec revêtement PLANET ou BINGO ELAST/MIRAGE et polyuréthane ignifuge (+6% sur le tarif)





Ignifugo + extra 6% da listino prezzi

Fireproof + extra 6% to price list

Non feu + extra 6% sur le tarif

Auckland

- **Rivestimento rete**
Meshnet upholstery
Revêtement en resille
- **Struttura in acciaio cromato**
Chromed structure
Structure chromé

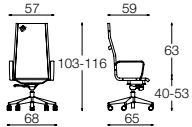
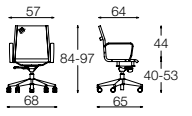
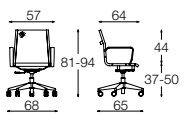
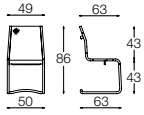
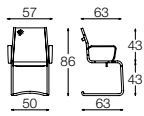
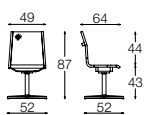
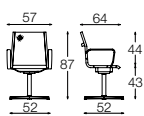
		Prezzo unitario € Unit price € Prix Unitaire €	 mc	 kg
SCHIENALE ALTO, base alluminio, regolazione gas knee-tilt HIGH BACKREST, gaslift knee-tilt, aluminium base DOSSIER HAUT, piètement en aluminium,regulation gaz knee-tilt				
AUAFALR92 Con braccioli fissi With arms Avec accoudoirs		550	0.33	18.8
SCHIENALE MEDIO, base alluminio, regolazione gas knee-tilt MEDIUM BACKREST, gaslift knee-tilt, aluminium base DOSSIER MOYEN, piètement en aluminium,regulation gaz knee-tilt				
AUBFALR92 Con braccioli fissi With arms Avec accoudoirs		530	0.24	14.75
SCHIENALE MEDIO, base alluminio, regolazione gas piastra MEDIUM BACKREST, gaslift, aluminium base DOSSIER MOYEN, piètement en aluminium,regulation gaz				
AUBPALR92 Con braccioli fissi With arms Avec accoudoirs		456	0.24	12.35
SCHIENALE MEDIO, telaio slitta cromato MEDIUM BACKREST, cantilever chromed frame DOSSIER MOYEN, piètement luge chromé				
AUBCALR01 Senza braccioli Without arms Sans accoudoirs		297	0.33	11.85
AUBCALR92 Con braccioli fissi With arms Avec accoudoirs		390	0.33	12.85
SCHIENALE MEDIO, telaio 4 razze girevole in alluminio altezza fissa, meccanismo di ritorno MEDIUM BACKREST, swivel 4 star aluminium frame fixed height, return mechanism DOSSIER MOYEN, piètement pivotant 4branches aluminium,hauteur fixe,mécanisme retour				
AUBTALR01 Senza braccioli Without arms Sans accoudoirs		431	0.24	13.75
AUBTALR92 Con braccioli fissi With arms Avec accoudoirs		516	0.24	14.75

RETE DISPONIBILE NEI SEGUENTI COLORI: NERO, GRIGIO, BIANCO, VEDERE "RETI AUCKLAND"
 MESH-NET AVAILABLE IN BLACK, GREY, WHITE COLOR, SEE "RETI AUCKLAND"
 RESILLES DISPONIBLES: NOIR, GRIS, BLANC, VOIR "RETI AUCKLAND"

Auckland

- **Imbottitura in poliuretano espanso**
Polyurethane foam padding
Rembourrage en mousse de polyuréthane
- **Struttura in acciaio cromato**
Chromed structure
Structure chromé

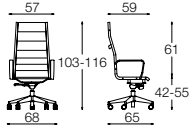
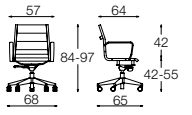
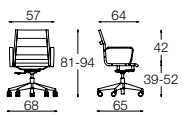
	Cat. F	Cat. G	Cat. S	Cat. TOP	Cat. EXTRA	Pelle Leather Cuir FIESTA	Pelle Leather Cuir NUVOLA	mc	kg
<p>SCHIENALE ALTO, base alluminio, regolazione gas knee-tilt HIGH BACKREST, gaslift knee-tilt, aluminium base DOSSIER HAUT, piètement en aluminium,regulation gaz knee-tilt</p> <p>AUAFALI92 Con braccioli fissi With arms Avec accoudoirs</p> 	658	670	720	746	790	876	1.019	0.33	18.8
<p>SCHIENALE MEDIO, base alluminio, regolazione gas knee-tilt MEDIUM BACKREST, gaslift knee-tilt, aluminium base DOSSIER MOYEN, piètement en aluminium,regulation gaz knee-tilt</p> <p>AUBFALI92 Con braccioli fissi With arms Avec accoudoirs</p> 	607	619	657	677	710	764	869	0.24	14.75
<p>SCHIENALE MEDIO, base alluminio, regolazione gas piastra MEDIUM BACKREST, gaslift, aluminium base DOSSIER MOYEN, piètement en aluminium,regulation gaz</p> <p>AUBPALI92 Con braccioli fissi With arms Avec accoudoirs</p> 	519	528	569	577	598	644	712	0.24	12.35

Consumi schienale alto tessuto / High back fabric consumption / Tissu nécessaire dossier haut **ml 1,90**

Consumi schienale alto pelle / High back leather consumption / Cuir nécessaire dossier haut **mq 2,70**

Consumi schienale medio tessuto / Medium back fabric consumption / Tissu nécessaire dossier moyen **ml 1,50**

Consumi schienale medio pelle / Medium back leather consumption / Cuir nécessaire dossier moyen **mq 2,10**



Omologazione ministeriale al fuoco in classe 1IM con rivestimento PLANET o BINGO ELAST / MIRAGE e poliuretano ignifugo (+6% da listino)

Fireproof Italian Ministry homologation in 1IM class with upholstery PLANET or BINGO ELAST / MIRAGE and fire retardant polyurethane (+6% to price list)
Certification Italienne contre le feu en classe 1IM avec revêtement PLANET ou BINGO ELAST/MIRAGE et polyuréthane ignifuge (+6% sur le tarif)



Ignifugo + extra 6% da listino prezzi

Fireproof + extra 6% to price list
Non feu + extra 6% sur le tarif

Auckland

- **Imbottitura in poliuretano espanso**
Polyurethane foam padding
Rembourrage en mousse de polyuréthane
- **Struttura in acciaio cromato**
Chromed structure
Structure chromé

			Cat. F	Cat. G	Cat. S	Cat. TOP	Cat. EXTRA	Pelle Leather Cuir FIESTA	Pelle Leather Cuir NUVOLA	mc	kg
SCHIENALE MEDIO, telaio slitta cromato MEDIUM BACKREST, cantilever chromed frame DOSSIER MOYEN, piètement luge chromé											
AUBCALI01	Senza braccioli Without arms Sans accoudoirs		383	393	430	452	485	540	642	0.33	11.85
AUBCALI92	Con braccioli fissi With arms Avec accoudoirs		485	494	532	553	586	641	745	0.33	12.85
SCHIENALE MEDIO, telaio 4 razze girevole in alluminio altezza fissa, meccanismo di ritorno MEDIUM BACKREST, swivel 4 star aluminium frame, return mechanism DOSSIER MOYEN, piètement pivotant 4 branches aluminium, hauteur fixe, mécanisme retour											
AUBTALI01	Senza braccioli Without arms Sans accoudoirs		511	520	562	568	591	637	706	0.24	13.75
AUBTALI92	Con braccioli fissi With arms Avec accoudoirs		580	588	631	637	658	706	773	0.24	14.75

Consumi schienale medio tessuto / Medium back fabric consumption / Tissu nécessaire dossier moyen **ml 1,50**

Consumi schienale medio pelle / Medium back leather consumption / Cuir nécessaire dossier moyen **mq 2,10**



Omologazione ministeriale al fuoco in classe 1IM con rivestimento PLANET o BINGO ELAST / MIRAGE e poliuretano ignifugo (+6% da listino)

Fireproof Italian Ministry homologation in 1IM class with upholstery PLANET or BINGO ELAST / MIRAGE and fire retardant polyurethane (+6% to price list)

Certification Italienne contre le feu en classe 1IM avec revêtement PLANET ou BINGO ELAST/MIRAGE et polyuréthane ignifuge (+6% sur le tarif)



Ignifugo + extra 6% da listino prezzi

Fireproof + extra 6% to price list





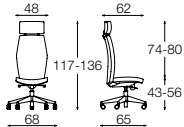
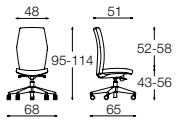

Non feu + extra 6% sur le tarif

Duke

EN-1335

- **Struttura sedile in faggio**
Seat structure in beech wood
Structure assise en hêtre
- **Imbottitura in poliuretano espanso**
Polyurethane foam padding
Rembourrage en mousse de polyuréthane
- **Struttura schienale in faggio**
Backrest structure in beech wood
Structure dossier en hêtre

	Cat. F	Cat. G	Cat. S	Cat. TOP	Cat. EXTRA	Pelle Leather Cuir FIESTA	Pelle Leather Cuir NUVOLA	mc	kg
SCHIENALE ALTO, regolazione gas sincron autoposante HIGH BACKREST, regulation gaslift synchro weight-self adjustment DOSSIER HAUT, regulation gaz synchrone avec auto-règlage du poids									
DKASNR01 Base nera, senza braccioli Black base, whitout arms Base noir, sans accoudoirs									
	659	675	743	754	805	886	1.005	0.34	20.1
SCHIENALE BASSO, regolazione gas sincron autoposante MEDIUM BACKREST, regulation gaslift synchro self-weight adjustment DOSSIER MOYEN, regulation gaz synchrone avec auto-règlage du poids									
DKBSNR01 Base nera, senza braccioli Black base, whitout arms Base noir, sans accoudoirs									
	502	516	586	596	647	729	849	0.33	18.8

Accessori / Accessories / Accessoires			Prezzo unitario € Unit price € Prix Unitaire €
AL	Base alluminio Aluminum base Piètement en aluminium		49
FVBRFN10	Coppia braccioli fissi neri Black fixed pair of arms Paire d'accoudoirs fixes noir		31
FVBRFB10	Coppia braccioli fissi bianchi White fixed pair of arms Paire d'accoudoirs fixes blanc		33
FTBR1DNR	Coppia braccioli regolabili neri 1d 1d black adjustable pair of arms Paire d'accoudoirs réglables 1D noir		33
FTBR1DBC	Coppia braccioli regolabili bianchi 1d 1d white adjustable pair of arms Paire d'accoudoirs réglables 1D blanc		35
BNBRG	Coppia braccioli regolabili neri 3d Black 3d adjustable pair of arms Paire d'accoudoirs réglables 3D noir		65

Consumi schienale alto tessuto / High back fabric consumption / Tissu nécessaire dossier haut **ml 2,20**

Consumi schienale alto pelle / High back leather consumption / Cuir nécessaire dossier haut **mq 3,60**

Consumi schienale medio tessuto / Medium back fabric consumption / Tissu nécessaire dossier moyen **ml 1,80**

Consumi schienale medio pelle / Medium back leather consumption / Cuir nécessaire dossier moyen **mq 3,00**



Omologazione ministeriale al fuoco in classe 1IM con rivestimento PLANET o BINGO ELAST / MIRAGE e poliuretano ignifugo (+6% da listino)
 Fireproof Italian Ministry homologation in 1IM class with upholstery PLANET or BINGO ELAST / MIRAGE and fire retardant polyurethane (+6% to price list)
 Certification Italienne contre le feu en classe 1IM avec revêtement PLANET ou BINGO ELAST/MIRAGE et polyuréthane ignifuge (+6% sur le tarif)



Ignifugo + extra 6% da listino prezzi
 Fireproof + extra 6% to price list
 Non feu + extra 6% sur le tarif

Halfpipe

EN-1335



- **Struttura sedile in legno**
Seat structure in wood
Structure assise en bois
- **Imbottitura in schiumato a freddo e poliuretano espanso**
Injected foam and polyurethane foam padding
Rembourrage en mousse moulée à froid et en mousse de polyuréthane
- **Struttura schienale in acciaio**
Backrest structure in steel
Structure dossier en acier

						Pelle Leather Cuir FIESTA	Pelle Leather Cuir NUVOLA	mc	kg	
SCHIENALE ALTO, base alluminio, regolazione gas sincron autoposante HIGH BACKREST, aluminum base, regulation synchron with self-weight adjustment DOSSIER HAUT, piètement en aluminium, régulation gaz synchrone avec auto-réglage du poids										
HPASAL01	Senza braccioli Without arms Sans accoudoirs		769	782	847	857	907	1.001	1.123	0.34 24.1
SCHIENALE MEDIO, base alluminio MEDIUM BACKREST, aluminum base DOSSIER MOYEN, piètement en aluminium										
HPBSAL01	Synchron autoposante, senza braccioli Synchron with weight-self adjustment, without arms Synchrone avec auto-réglage du poids, sans accoudoirs		598	610	662	670	709	785	883	0.32 19.75
HPBPAL01	Gas, senza braccioli Gaslift, without arms Gaz, sans accoudoirs		562	572	625	633	671	749	846	0.32 18.75
SCHIENALE MEDIO, telaio 4 razze girevole in alluminio altezza fissa MEDIUM BACKREST, swivel 4 star aluminium frame DOSSIER MOYEN, piètement pivotant 4 branches aluminium, hauteur fixe										
HPBTAL01	Senza braccioli Without arms Sans accoudoirs		602	613	666	674	714	792	875	0.32 16.75

Halfpipe

EN-1335

- **Struttura sedile in legno**
Seat structure in wood
Structure assise en bois
- **Imbottitura in schiumato a freddo e poliuretano espanso**
Injected foam and polyurethane foam padding
Rembourrage en mousse moulée à froid et en mousse de polyuréthane
- **Struttura schienale in acciaio**
Backrest structure in steel
Structure dossier en acier

Accessori / Accessories / Accessoires			Cat. F	Cat. G	Cat. S	Cat. TOP	Cat. EXTRA	Pelle Leather Cuir FIESTA	Pelle Leather Cuir NUVOLA
HPBRIM	Coppia braccioli imbottiti e rivestiti Padded and upholstered pair of armrests Pair d'accoudoirs rembourrés et revêtus		302	308	333	337	356	385	430
HPBRALIM	Coppia braccioli in alluminio con top rivestito Aluminium pair of arms with upholstered top Pair d'accoudoirs en aluminium avec top revêtu		302	308	333	337	356	385	430
Accessori / Accessories / Accessoires			Prezzo unitario € Unit price € Prix Unitaire €						
	Colonna autoallineante per base 4 lame Return mechanism for 4 blades frame Mécanisme de retour sur piètement 4 branches		64						

CUCITURE ORIZZONTALI: + € 100

HORIZONTAL STITCHINGS: + € 100

COUTURES HORIZONTALES: +€100

Consumi schienale alto tessuto / High back fabric consumption / Tissu nécessaire dossier haut **ml 2,10**

Consumi schienale alto pelle / High back leather consumption / Cuir nécessaire dossier haut **mq 3,60**

Consumi schienale medio tessuto / Medium back fabric consumption / Tissu nécessaire dossier moyen **ml 1,70**

Consumi schienale medio pelle / Medium back leather consumption / Cuir nécessaire dossier moyen **mq 2,90**

Consumi braccioli imbottiti tessuto / Padded arms consumption fabric / Tissu nécessaire accoudoirs **ml 0,90**

Consumi braccioli imbottiti pelle / Padded arms consumption leather / Cuir nécessaire accoudoirs **mq 1,40**



Omologazione ministeriale al fuoco in classe 1IM con rivestimento PLANET o BINGO ELAST / MIRAGE e poliuretano ignifugo (+6% da listino)

Fireproof Italian Ministry homologation in 1IM class with upholstery PLANET or BINGO ELAST / MIRAGE and fire retardant polyurethane (+6% to price list)

Certification Italienne contre le feu en classe 1IM avec revêtement PLANET ou BINGO ELAST/MIRAGE et polyuréthane ignifuge (+6% sur le tarif)



Ignifugo + extra 6% da listino prezzi

Fireproof + extra 6% to price list

Non feu + extra 6% sur le tarif



Halfpipe

EN-1728

EN-1022

EN 16139

- **Struttura sedile in legno**
Seat structure in wood
Structure assise en bois
- **Imbottitura in schiumato a freddo e poliuretano espanso**
Injected foam and polyurethane foam padding
Rembourrage en mousse moulée à froid et en mousse de polyuréthane
- **Struttura schienale in acciaio**
Backrest structure in steel
Structure dossier en acier

	Cat. F	Cat. G	Cat. S	Cat. TOP	Cat. EXTRA	Pelle Leather Cuir FIESTA	Pelle Leather Cuir NUVOLA	 mc	 kg
SCHIENALE MEDIO, telaio slitta cromato MEDIUM BACKREST, cantilever chromed base DOSSIER MOYEN, piètement luge chromé									
HPBCCR01 Con braccioli fissi With arms Avec accoudoirs	571	583	635	645	683	762	861	0.38	17.75

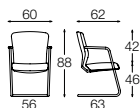

Consumi schienale medio / Cantilever fabric consumption / Tissu nécessaire dossier moyen **ml 1,70**

Consumi schienale medio pelle / Cantilever leather consumption / Cuir nécessaire dossier moyen **mq 2,90**



Omologazione ministeriale al fuoco in classe 1IM con rivestimento PLANET o BINGO ELAST / MIRAGE e poliuretano ignifugo (+6% da listino)

Fireproof Italian Ministry homologation in 1IM class with upholstery PLANET or BINGO ELAST / MIRAGE and fire retardant polyurethane (+6% to price list)

Certification Italienne contre le feu en classe 1IM avec revêtement PLANET ou BINGO ELAST/MIRAGE et polyuréthane ignifuge (+6% sur le tarif)





Ignifugo + extra 6% da listino prezzi

Fireproof + extra 6% to price list

Non feu + extra 6% sur le tarif

Liberty

■ **Struttura in polipropilene nero**
 Structure in polypropylene black
 Coque en polypropylène noir

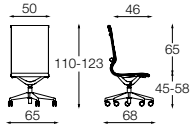
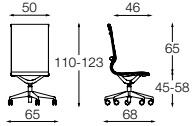
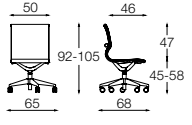
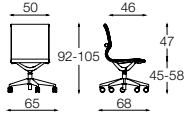
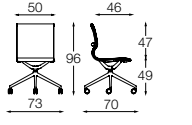
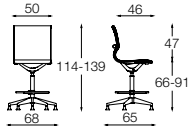

		Prezzo unitario € Unit price € Prix Unitaire €		 mc	 kg
SCHIENALE ALTO, base 5 razze in polipropilene nero, balance ed elevazione a gas HIGH BACKREST, black nylon 5 star base, balance and gaslift DOSSIER HAUT, piétement 5 rayons en polypropylène noir, oscillant et gaz					
LIA5RNR_ _ Senza braccioli Without arms Sans accoudoirs		435	0.33	12.8	
SCHIENALE ALTO, base 5 razze in polipropilene nero, tilt ed elevazione a gas HIGH BACKREST, black nylon 5 star base, tilt and gaslift DOSSIER HAUT, piétement 5 rayons en polypropylène noir, tilt et gaz					
LIA5KRNR_ _K Senza braccioli Without arms Sans accoudoirs		485	0.33	13.8	
SCHIENALE MEDIO, base 5 razze in polipropilene nero, balance ed elevazione a gas MID BACKREST, black nylon 5 star base, balance and gaslift DOSSIER MOYENNE, piétement 5 rayons en polypropylène noir, oscillant et gaz					
LIB5RNR_ _ Senza braccioli Without arms Sans accoudoirs		360	0.24	10.75	
SCHIENALE MEDIO, base 5 razze in polipropilene nero, tilt ed elevazione a gas MID BACKREST, black nylon 5 star base, tilt and gaslift DOSSIER MOYENNE, piétement 5 rayons en polypropylène noir, tilt et gaz					
LIB5RNR_ _K Senza braccioli Without arms Sans accoudoirs		410	0.24	11.75	
SCHIENALE MEDIO, base 4 razze in alluminio lucido o nero, balance e girevole MID BACKREST, 4 star base in polished aluminium or black lacquered, balance and swivel DOSSIER MOYENNE, piétement 4 rayons en aluminium poli ou noir, oscillant et pivotant					
LIB4RNR_ _ Senza braccioli Without arms Sans accoudoirs		413	0.24	10.75	
SGABELLO OPERATIVO, base 5 razze in polipropilene, balance ed elevazione a gas TASK STOOL, black nylon 5 star base, balance and gaslift TABOURET, piétement 5 rayons en polypropylène noir, oscillant et gaz					
LIS5RNR_ _ Senza braccioli Without arms Sans accoudoirs		429	0.24	18.05	

RETI DISPONIBILI: RETI LIBERTY NERO (NR) E BIANCO (BC)

MESH TO APPLY: LIBERTY MESHES BLACK (NR) AND WHITE (BC)
 RESILLES DISPONIBLES: RESILLES LIBERTY NOIR (NR) ET BLANC (BC)

Liberty

■ **Struttura in polipropilene nero**
 Structure in polypropylene black
 Coque en polypropylène noir

Accessori / Accessories / Accessoires			Prezzo unitario € Unit price € Prix Unitaire €
LIBRFNR	Braccioli fissi neri Black fixed arms Accoudoirs fixes noir		28
AL	Base alluminio Aluminium base Pièment en aluminium		49
RF__	Ruote forate bianche (BC) o nere (NR) - design Philippe Starck White (BC) or BLACK (NR) castors with holes - design Philippe Starck Roulettes avec trous blanc (BC) ou noir (NR) - design Philippe Starck		40

Accessori / Accessories / Accessoires	Cat. F	Cat. G	Cat. S	Cat. TOP	Cat. EXTRA	Pelle Leather Cuir FIESTA	Pelle Leather Cuir NUVOLA
LIACCA Cuscino tappezzato, schienale alto Upholstered high back cushion Coussin tapissé, dossier haut	159	170	212	244	286	371	509
LIACCB Cuscino tappezzato, schienale medio Upholstered medium back cushion Coussin tapissé, dossier moyen	138	148	191	223	265	350	488

Consumi schienale alto tessuto / High back fabric consumption / Tissu nécessaire dossier haut **ml 1,90**

Consumi schienale alto pelle / High back leather consumption / Cuir nécessaire dossier haut **mq 2,70**

Consumi schienale medio tessuto / Medium back fabric consumption / Tissu nécessaire dossier moyen **ml 1,50**

Consumi schienale medio pelle / Medium back leather consumption / Cuir nécessaire dossier moyen **mq 2,10**



Omologazione ministeriale al fuoco in classe 1IM con rivestimento PLANET o BINGO ELAST / MIRAGE e poliuretano ignifugo (+6% da listino)

Fireproof Italian Ministry homologation in 1IM class with upholstery PLANET or BINGO ELAST / MIRAGE and fire retardant polyurethane (+6% to price list)
 Certification Italienne contre le feu en classe 1IM avec revêtement PLANET ou BINGO ELAST/MIRAGE et polyuréthane ignifuge (+6% sur le tarif)



Ignifugo + extra 6% da listino prezzi

Fireproof + extra 6% to price list
 Non feu + extra 6% sur le tarif

- **Struttura sedile in polipropilene**
Seat structure in polypropylene
Structure assise en polypropylène
- **Imbottitura in schiumato a freddo**
Padding in injected foam
Rembourrage en mousse moulée à froid
- **Schienale in polipropilene con supporto lombare regolabile**
Polypropylene backrest with adjustable lumbar support
Structure dossier en polypropylène avec support lombaire

			Cat. F	Cat. G	Cat. S	Cat. TOP	Cat. EXTRA	Pelle Leather Cuir FIESTA	Pelle Leather Cuir NUVOLA	mc	kg
SCHIENALE ALTO, base alluminio, regolazione gas syncron, traslatore, appoggiatesta in pelle nera HIGH BACKREST, aluminum base, regulation gaslift syncron and slide system with black leather headrest DOSSIER HAUT, piètement en aluminium,regulation gaz synchrone, translation assise, appuye-tete en cuir noir											
SLATAL43	Con braccioli regolabili 2d With 2d adjustable arms Avec accoudoirs réglables 2d		915	926	954	966	989	1.013	1.076	0.34	24.8
SCHIENALE MEDIO,base alluminio, regolazione gas syncron, traslatore MEDIUM BACKREST, aluminum base, regulation gaslift syncron and slide system DOSSIER MOYEN, piètement en aluminium,regulation gaz synchrone, translation assise											
SLBTAL43	Con braccioli regolabili 2d With 2d adjustable arms Avec accoudoirs réglables 2d		868	880	907	919	942	966	1.030	0.33	23.8

Consumi tessuto / Fabric consumption / Tissu nécessaire **ml 0,90**

Consumi pelle / Leather consumption / Cuir nécessaire **mq 1,40**



Omologazione ministeriale al fuoco in classe 1IM con rivestimento PLANET o BINGO ELAST / MIRAGE e poliuretano ignifugo (+6% da listino)

Fireproof Italian Ministry homologation in 1IM class with upholstery PLANET or BINGO ELAST / MIRAGE and fire retardant polyurethane (+6% to price list)

Certification Italienne contre le feu en classe 1IM avec revêtement PLANET ou BINGO ELAST/MIRAGE et polyuréthane ignifuge (+6% sur le tarif)

Velvet

EN-1335

- **Struttura sedile in polipropilene**
Seat structure in polypropylene
Structure d'assise en polypropylène
- **Imbottitura in poliuretano espanso**
Polyurethane foam padding
Rembourrage en mousse de polyuréthane
- **Schienale in poliuretano strutturale**
Backrest in rigid structural polyurethane
Dossier en polyuréthane structural





			Cat. F	Cat. G	Cat. S	Cat. TOP	Cat. EXTRA	Pelle Leather Cuir FIESTA	Pelle Leather Cuir NUVOLA	mc	kg
SCHIENALE ALTO, regolazione sincron autopessante, senza braccioli HIGH BACKREST, synchro regulation weight-self adjustment, no arms DOSSIER HAUT, mécanisme synchro avec auto-règlage du poids, sans accoudoirs											
VEASAL01	Base alluminio Aluminium base Pièment en aluminium		786	797	857	863	901	1.010	1.086	0.34	22.1
SCHIENALE MEDIO, regolazione sincron auto pesante, senza braccioli MEDIUM BACKREST, synchro regulation weight-self adjustment, no arms DOSSIER MOYENNE, mécanisme synchro avec auto-règlage du poids, sans accoudoirs											
VEMSAL01	Base alluminio Aluminium base Pièment en aluminium		759	770	813	819	852	944	1.010	0.33	20.8
SCHIENALE MEDIO, regolazione sincron autopessante, solo girevole NO gas, senza braccioli, 4 razze su ruote o piedini MEDIUM BACKREST, regulation weight-self adjustment synchro only swivel, NO gas, 4 stars on wheels or glides DOSSIER MOYEN, mécanisme synchro avec auto-règlage du poids, sans accoudoirs, NO gaz, pivotant, 4 rayons sur roulettes ou patins											
VEMRSNR01	Base in alluminio verniciata nera Black lacquered aluminium base Pièment en aluminium laqué noir		753	764	808	819	852	939	994	0.33	19.8
VEMRSAL01	Base alluminio Aluminium base Pièment en aluminium		775	786	830	841	873	961	1.015	0.33	19.8
SCHIENALE MEDIO, regolazione sincron autopessante, senza braccioli MEDIUM BACKREST, regulation weight-self adjustment synchro, without arms DOSSIER MOYEN, mécanisme synchro avec auto-règlage du poids, sans accoudoirs											
VEM4WN01	Telaio 4 gambe in frassino naturale, girevole 4 legs ash wooden frame, swivel 4 pieds en frêne naturelle, pivotant		941	948	996	1.007	1.060	1.124	1.187	0.33	20.3
LOUNGE, SCHIENALE ALTO, regolazione sincron auto pesante, senza braccioli LOUNGE, HIGH BACKREST, synchro regulation weight-self adjustment, no arms LOUNGE, DOSSIER HAUT, mécanisme synchro avec auto-règlage du poids, sans accoudoirs											
VEALNR01	Base in alluminio nera 4 razze 4 star black lacquered aluminium base Pièment 4 rayons en aluminium laqué noir		832	837	890	901	965	1.055	1.129	0.34	21.1
EOLPP4NR	Poggiapiedi, telaio 4 razze alluminio nero girevole Footrest, swivel 4 blades black aluminium frame Repose-pied, pièment 4 branches aluminium noir		497	502	540	546	573	644	693	0.24	7.25

Velvet

EN-1335

- **Struttura sedile in polipropilene**
Seat structure in polypropylene
Structure d'assise en polypropylène
- **Imbottitura in poliuretano espanso**
Polyurethane foam padding
Rembourrage en mousse de polyuréthane
- **Schienale in poliuretano strutturale**
Backrest in rigid structural polyurethane
Dossier en polyuréthane structural

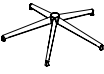
Accessori / Accessories / Accessoires		Cat. F	Cat. G	Cat. S	Cat. TOP	Cat. EXTRA	Pelle Leather Cuir FIESTA	Pelle Leather Cuir NUVOLA	
VEBRALIM	Coppia di braccioli imbottiti e rivestiti Pair of padded and upholstered arms Paire d'accoudoirs rembourrés et revêtus		313	318	334	339	355	376	398

Accessori / Accessories / Accessoires		Prezzo unitario € Unit price € Prix Unitaire €	
VEBRAL	Coppia di braccioli fissi in alluminio Pair of aluminium fixed arms Paire d'accoudoirs fixes en aluminium		265
VEBRNR	Coppia di braccioli fissi in alluminio verniciati neri Pair of aluminium fixed arms, black lacquered Paire d'accoudoirs fixes en aluminium laqués noirs		212
AL +	Base alluminio lucido o verniciata nera design Polished aluminium or black lacquered Design base Pièment Design en aluminium ou laqué noir		58
RF	Ruote forate grigie/nera Castors with holes grey/black Roulettes avec trous gris/noir		35
RF__	Ruote forate bianche (BC) o nere (NR) - design Philippe Starck White (BC) or BLACK (NR) castors with holes - design Philippe Starck Roulettes avec trous blanc (BC) ou noir (NR) - design Philippe Starck		40

Accessori / Accessories / Accessoires		Cat. F	Cat. G	Cat. S	Cat. TOP	Cat. EXTRA	Pelle Leather Cuir FIESTA	Pelle Leather Cuir NUVOLA
VEIR	Inserito laterale a contrasto Side detail in different color Insert latéral de couleur différente	42	48	53	58	64	74	85
VEPT	Poggiatesta imbottito Padded headrest Appui-tête rembourré		148	154	175	180	228	254

Consumi schienale alto tessuto / High back fabric consumption / Tissu nécessaire dossier haut **ml 1,70**

Consumi schienale alto pelle / High back leather consumption / Cuir nécessaire dossier haut **mq 2,70**

Consumi schienale medio tessuto / Medium back fabric consumption / Tissu nécessaire dossier moyen **ml 1,50**

Consumi schienale medio pelle / Medium back leather consumption / Cuir nécessaire dossier moyen **mq 2,50**

Consumo braccioli tessuto / Arms fabric consumption / Tissu nécessaire accoudoirs **ml 0,80**

Consumo braccioli pelle / Arms leather consumption / Cuir nécessaire accoudoirs **mq 1,10**



Omologazione ministeriale al fuoco in classe 1IM con rivestimento PLANET o BINGO ELAST / MIRAGE e poliuretano ignifugo (+6% da listino)

Fireproof Italian Ministry homologation in 1IM class with upholstery PLANET or BINGO ELAST / MIRAGE and fire retardant polyurethane (+6% to price list)

Certification ministérielle contre le feu en classe 1IM avec revêtement PLANET ou BINGO ELAST / MIRAGE et polyuréthane ignifuge (+ 6% à partir de la liste de prix)



Ignifugo + extra 6% da listino prezzi

Fireproof + extra 6% to price list

Non feu + extra 6% sur le tarif

Venus

EN-1335

- **Imbottitura in poliuretano espanso**
Polyurethane foam padding
Rembourrage en mousse de polyuréthane
- **Scocca in multistrato curvato**
Shell in multilayer beech wood
Coque en bois multiplis

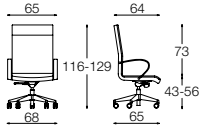
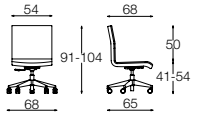
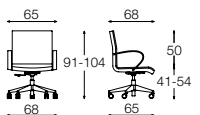
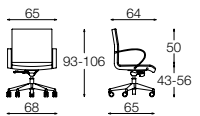
	Cat. F	Cat. G	Cat. S	Cat. TOP	Cat. EXTRA	Pelle Leather Cuir FIESTA	Pelle Leather Cuir NUVOLA	mc	kg
SCHIENALE ALTO, base alluminio, regolazione gas knee-tilt HIGH BACKREST, aluminium base, gaslift knee-tilt DOSSIER HAUT, piètement en aluminium, régulation gaz knee-tilt									
VNAKAL82 Con braccioli cromati imbottiti With padded arms Avec accoudoirs chromés revêtus 	665	677	734	765	807	842	987	0.34	19.3
SCHIENALE MEDIO, base alluminio, regolazione gas piastra MEDIUM BACKREST, aluminium base, gaslift DOSSIER MOYEN, piètement en aluminium, régulation gaz									
VNBPAL01 Senza braccioli Without arms Sans accoudoirs 	460	470	520	549	583	623	758	0.32	15.25
VNBPAL82 Con braccioli cromati imbottiti With padded arms Avec accoudoirs chromés revêtus 	580	588	639	667	703	742	877	0.32	17.25
SCHIENALE MEDIO, base alluminio, regolazione gas knee-tilt MEDIUM BACKREST, aluminium base, knee-tilt DOSSIER MOYEN, piètement en aluminium, régulation gaz knee-tilt									
VNBKAL82 Con braccioli cromati imbottiti With padded arms Avec accoudoirs chromés revêtus 	617	630	679	707	741	783	918	0.33	19.3

Consumi schienale alto tessuto / High back fabric consumption / Tissu nécessaire dossier haut **ml 2,50**

Consumi presidenziale pelle / High back leather consumption / Cuir nécessaire dossier haut **mq 4,00**

Consumi schienale medio tessuto / Medium back fabric consumption / Tissu nécessaire dossier moyen **ml 2,00**

Consumi schienale medio pelle / Medium back leather consumption / Cuir nécessaire dossier moyen **mq 3,30**



Omologazione ministeriale al fuoco in classe 1IM con rivestimento PLANET o BINGO ELAST / MIRAGE e poliuretano ignifugo (+6% da listino)

Fireproof Italian Ministry homologation in 1IM class with upholstery PLANET or BINGO ELAST / MIRAGE and fire retardant polyurethane (+6% to price list)

Certification Italienne contre le feu en classe 1IM avec revêtement PLANET ou BINGO ELAST/MIRAGE et polyuréthane ignifuge (+6% sur le tarif)



Ignifugo + extra 6% da listino prezzi

Fireproof + extra 6% to price list

Non feu + extra 6% sur le tarif

Venus

- **Struttura sedile in polipropilene**
Seat structure in polypropylene
Structure assise en polypropylène
- **Imbottitura in schiumato a freddo**
Injected foam padding
Rembourrage en mousse moulée à froid
- **Schienale in polipropilene**
Backrest structure in polypropylene
Structure dossier en polypropylène

	Cat. F	Cat. G	Cat. S	Cat. TOP	Cat. EXTRA	Pelle Leather Cuir FIESTA	Pelle Leather Cuir NUVOLA	mc	kg	
SCHIENALE BASSO, telaio slitta cromato LOW BACKREST, cantilever chromed frame DOSSIER BAS, piètement luge chromé										
VNSC11 Con braccioli cromati integrati With chromed arms Avec accoudoirs chromés intégrés	423	429	457	470	492	507	576	0.33	11.95	max 3 pz 3 pcs 3 pcs

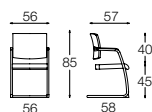

Consumi schienale basso / Fabric consumption / Tissu nécessaire dossier bas **ml 1,10**
Consumi pelle / Leather consumption / Cuir nécessaire dossier bas **mq 1,60**



Omologazione ministeriale al fuoco in classe 1IM con rivestimento PLANET o BINGO ELAST / MIRAGE e poliuretano ignifugo (+6% da listino)
Fireproof Italian Ministry homologation in 1IM class with upholstery PLANET or BINGO ELAST / MIRAGE and fire retardant polyurethane (+6% to price list)
Certification Italienne contre le feu en classe 1IM avec revêtement PLANET ou BINGO ELAST/MIRAGE et polyuréthane ignifuge (+6% sur le tarif)



Ignifugo + extra 6% da listino prezzi
Fireproof + extra 6% to price list
Non feu + extra 6% sur le tarif

“Dove lo spazio può incoraggiare la produttività attraverso il design: è proprio lì che si crea l'ambiente di lavoro del futuro.

Cerchiamo di creare un equilibrio tra la nostra filosofia di design e la creazione di spazi che, a fine giornata, facciano sentire le persone comode, in un posto accogliente, e libere, proprio come a casa loro.”

Operative

Task chairs / Sièges de bureau

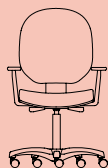

BINGO

32

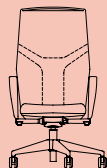

FIT

33

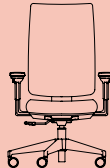

FIVE

37

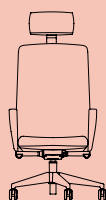

GOAL

39

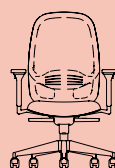

HOP

40

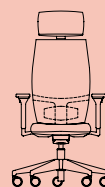

LEAD

41



SKIN

43

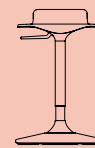

OBLÒ

46





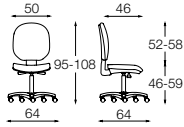
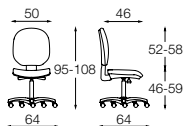

“Where space can encourage productivity through design: this is precisely where the workspaces of the future can be created. We try to create a balance between our design philosophy and the creation of spaces which make people feel comfortable, in a welcoming place, and free, just like at home.”

Bingo

EN-1335

- **Struttura sedile in polipropilene**
Seat structure in polypropylene
Structure assise en polypropylène
- **Imbottitura in poliuretano espanso**
Polyurethane foam padding
Rembourrage en mousse de polyuréthane
- **Struttura schienale in polipropilene**
Backrest structure in polypropylene
Structure dossier en polypropylène

		Cat. F	Cat. G	Cat. S	Cat. TOP	Cat. EXTRA	Pelle Leather Cuir FIESTA	Pelle Leather Cuir NUVOLA	mc	kg
SEDIA OPERATIVA, regolazione mini-syncron TASK CHAIR, mini-syncron SIEGE DE BUREAU, mini-synchrone										
BNAMNNR01	Plastiche nere, senza braccioli Black plastic, without arms Plastique noir, sans accoudoirs									
		217	220	238	241	255	281	316	0.21	15.75
BNAMGGR01	Plastiche grigie, senza braccioli Grey plastic, without arms Plastique gris, sans accoudoirs									
		235	238	257	260	273	301	336	0.21	15.75

Accessori / Accessories / Accessoires			Prezzo unitario € Unit price € Prix Unitaire €	
ZPBFN12	Coppia braccioli fissi neri Black fixed pair of arms Pair d'accoudoirs fixes noir			27
BNBFG12	Coppia braccioli fissi grigi Grey fixed pair of arms Pair d'accoudoirs fixes gris			29
FTBR1DNR	Coppia braccioli regolabili neri 1d 1d adjustable black pair of arms Pair d'accoudoirs réglables 1d noir			33
FTBR1DGR	Coppia braccioli regolabili grigi 1d 1d adjustable grey pair of arms Pair d'accoudoirs réglables 1d gris			35
BNBRG	Coppia braccioli regolabili neri 3d 3d adjustable black pair of arms Pair d'accoudoirs réglables 3d noir			65
AL	Base alluminio Aluminium base Piètement en aluminium			49

Consumi tessuto / Fabric consumption / Tissu nécessaire ml 0,85

Consumi pelle / Leather consumption / Cuir nécessaire mq 1,30



Omologazione ministeriale al fuoco in classe 1IM con rivestimento PLANET o BINGO ELAST / MIRAGE e poliuretano ignifugo (+6% da listino)
Fireproof Italian Ministry homologation in 1IM class with upholstery PLANET or BINGO ELAST / MIRAGE and fire retardant polyurethane (+6% to price list)
Certification Italienne contre le feu en classe 1IM avec revêtement PLANET ou BINGO ELAST/MIRAGE et polyuréthane ignifuge (+6% sur le tarif)



Ignifugo + extra 6% da listino prezzi
Fireproof + extra 6% to price list
Non feu + extra 6% sur le tarif

Fit mesh/poly

EN-1335

EN-1728

EN-1022

- **Struttura sedile in multistrato di faggio**
Seat structure in multilayer beech wood
Structure assise en hêtre
- **Imbottitura in poliuretano espanso**
Polyurethane foam padding
Rembourrage en mousse de polyuréthane
- **Struttura schienale in polipropilene**
Backrest structure in polypropylene
Structure dossier en polypropylène

	Cat. F	Cat. G	Cat. S	Cat. TOP	Cat. EXTRA	Pelle Leather Cuir FIESTA	Pelle Leather Cuir NUVOLA	mc	kg
SCHIENALE IN RETE, regolazione sincron autopesante MESH-NET BACKREST, self-weight adjustment synchron DOSSIER EN RESILLE, synchrone avec auto-réglage du poids									
FTSRNRR01 Plastiche nere, senza braccioli Black plastic, without arms Plastique noir, sans accoudoirs									
	357	359	369	371	380	402	425	0.21	16.35
FTSRBBC01 Plastiche bianche, senza braccioli White plastic, without arms Plastique blanc, sans accoudoirs									
	407	409	420	423	431	455	479	0.21	16.35
SCHIENALE IN POLIPROPILENE, regolazione sincron autopesante POLYPROPYLENE BACK, self-weight adjustment synchron DOSSIER EN POLYPROPYLENE, synchrone avec auto-réglage du poids									
FTSPNRR01 Plastiche nere, senza braccioli Black plastic, without arms Plastique noir, sans accoudoirs									
	357	359	369	371	380	402	425	0.21	16.95
FTSPBBC01 Plastiche bianche, senza braccioli White plastic, without arms Plastique blanc, sans accoudoirs									
	407	409	420	423	431	455	479	0.21	16.95
SCHIENALE IN RETE O POLY, telaio slitta cromata MESH-NET or POLY BACKREST, cantilever chromed frame DOSSIER EN RESILLE OU POLY, piètement luge chromé									
FTCRNCR01 Plastiche nere, senza braccioli Black plastic, without arms Plastique noir, sans accoudoirs									
	270	272	282	284	293	314	337	0.38	12.55
FTCRBCR01 Plastiche bianche, senza braccioli White plastic, without arms Plastique blanc, sans accoudoirs									
	300	302	313	316	323	345	368	0.38	12.55

COLORI RETE DISPONIBILI: BIANCO, NERO, VEDERE "RETI FIT"

COLORS OF MESH AVAILABLE: WHITE, BLACK, SEE "RETI FIT"

RESILLES DISPONIBLES: BLANC, NOIR, VOIR "RETI FIT"

Consumi sedile rivestito tessuto / Consumption padded seat fabric / Tissu nécessaire assise ml 0,60

Consumi sedile rivestito pelle / Consumption padded seat leather / Cuir nécessaire assise revetue mq 0,80



Omologazione ministeriale al fuoco in classe 1IM con rivestimento PLANET o BINGO ELAST / MIRAGE e poliuretano ignifugo (+6% da listino)

Fireproof Italian Ministry homologation in 1IM class with upholstery PLANET or BINGO ELAST / MIRAGE and fire retardant polyurethane (+6% to price list)

Certification Italienne contre le feu en classe 1IM avec revêtement PLANET ou BINGO ELAST/MIRAGE et polyuréthane ignifuge (+6% sur le tarif)



Ignifugo + extra 6% da listino prezzi

Fireproof + extra 6% to price list

Non feu + extra 6% sur le tarif

Fit mesh/poly

EN-1335

EN-1728

EN-1022

■ **Struttura sedile in multistrato di faggio**













Seat structure in multilayer beech wood
Structure assise en hêtre

■ **Imbottitura sedile in poliuretano espanso**

Polyurethane foam seat padding
Rembourrage en mousse de polyuréthane

■ **Struttura schienale in polipropilene e termoformato**









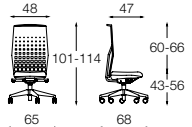
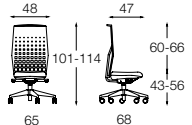

Backrest structure in polypropylene and thermoformed
Structure dossier en polypropylène et tissu postformé

Accessori / Accessories / Accessoires			Prezzo unitario € Unit price € Prix Unitaire €
FVBRFN10	Coppia braccioli fissi neri Black fixed pair of arms Pair d'accoudoirs fixes noir		31
FVBRFB10	Coppia braccioli fissi bianchi White fixed pair of arms Pair d'accoudoirs fixes blanc		33
FTBR1DNR	Coppia braccioli regolabili neri 1d 1d black adjustable pair of arms Pair d'accoudoirs réglables 1d noir		33
FTBR1DCN	Coppia braccioli regolabili neri 1d cromo 1d black adjustable pair of arms, chromed Pair d'accoudoirs réglables 1d noir, chromé		55
FTBR1DBC	Coppia braccioli regolabili bianchi 1d 1d white adjustable pair of arms Pair d'accoudoirs réglables 1d blanc		35
FTBR1DCB	Coppia braccioli regolabili bianchi 1d cromo 1d white adjustable pair of arms, chromed Pair d'accoudoirs réglables 1d blanc, chromé		60
BNBRG	Coppia braccioli regolabili neri 3d Black 3d adjustable pair of arms Pair d'accoudoirs réglables 3d noir		65
FTPTIN	Appoggiatesta nero imbottito e rivestito Black headrest, padded and upholstered Appuie-tête noir, revêtu		66
FTPTIB	Appoggiatesta bianco imbottito e rivestito White headrest, padded and upholstered Appuie-tête blanc, revêtu		72
T	Traslatore Slide system Translation assise		42
AL	Base alluminio Aluminium base Piètement en aluminium		49
RF_ _	Ruote forate bianche (BC) o nere (NR) - design Philippe Starck White (BC) or BLACK (NR) castors with holes - design Philippe Starck Roulettes avec trous blanc (BC) ou noir (NR) - design Philippe Starck		40

Fit up

EN-1335 EN-1728 EN-1022

- **Struttura sedile in multistrato di faggio**
Seat structure in multilayer beech wood
Structure assise en hêtre
- **Imbottitura sedile in poliuretano espanso**
Polyurethane foam seat padding
Rembourrage en mousse de polyuréthane
- **Struttura schienale in polipropilene e termoformato**
Backrest structure in polypropylene and thermoformed
Structure dossier en polypropylène et tissu postformé

			Prezzo unitario € Unit price € Prix Unitaire €	 mc	 kg
SCHIENALE IN TESSUTO TERMOFORMATO, sincron autopesante THERMOFORMED FABRIC BACK, self-weight adjustment synchron DOSSIER EN TISSU POSTFORME', synchrone avec auto-réglage du poids					
FTTFNNR01	<p>Plastiche nere, senza braccioli Black plastic, without arms Plastique noir, sans accoudoirs</p> 	<p>48 47 101-114 60-66 65 68 43-56</p>	410	0.32	16.35
FTTFBBC01	<p>Plastiche bianche, senza braccioli White plastic, without arms Plastique blanc, sans accoudoirs</p> 	<p>48 47 101-114 60-66 65 68 43-56</p>	456	0.32	16.35
Accessori / Accessories / Accessoires			Prezzo unitario € Unit price € Prix Unitaire €		
FVBRFN10	<p>Coppia braccioli fissi neri Black fixed pair of arms Pair d'accoudoirs fixes noir</p> 		31		
FVBRFB10	<p>Coppia braccioli fissi bianchi White fixed pair of arms Pair d'accoudoirs fixes blanc</p> 		33		
FTBR1DNR	<p>Coppia braccioli regolabili neri 1d 1d black adjustable pair of arms Pair d'accoudoirs réglables 1d noir</p> 		33		
FTBR1DCN	<p>Coppia braccioli regolabili neri 1d cromo 1d black adjustable pair of arms, chromed Pair d'accoudoirs réglables 1d noir, chromé</p> 		55		
FTBR1DBC	<p>Coppia braccioli regolabili bianchi 1d 1d white adjustable pair of arms Pair d'accoudoirs réglables 1d blanc</p> 		35		
FTBR1DCB	<p>Coppia braccioli regolabili bianchi 1d cromo 1d white adjustable pair of arms, chromed Pair d'accoudoirs réglables 1d blanc, chromé</p> 		60		
BNBRG	<p>Coppia braccioli regolabili neri 3d Black 3d adjustable pair of arms Pair d'accoudoirs réglables 3d noir</p> 		65		
FTPTIN	<p>Appoggiatesta nero imbottito e rivestito Black headrest, padded and upholstered Appuie-tête noir, revêtu</p> 		66		





Fit up

EN-1335

EN-1728

EN-1022

- **Struttura sedile in multistrato di faggio**
Seat structure in multilayer beech wood
Structure assise en hêtre
- **Imbottitura sedile in poliuretano espanso**
Polyurethane foam seat padding
Rembourrage en mousse de polyuréthane
- **Struttura schienale in polipropilene e termoformato**
Backrest structure in polypropylene and thermoformed
Structure dossier en polypropylène et tissu postformé

Accessori / Accessories / Accessoires			Prezzo unitario € Unit price € Prix Unitaire €
FTPTIB	Appoggiatesta bianco imbottito e rivestito White headrest, padded and upholstered Appuie-tête blanc, revêtu		72
T	Traslatore Slide system Translation assise		42
AL	Base alluminio Aluminium base Piètement en aluminium		49
RF_ _	Ruote forate bianche (BC) o nere (NR) - design Philippe Starck White (BC) or BLACK (NR) castors with holes - design Philippe Starck Roulettes avec trous blanc (BC) ou noir (NR) - design Philippe Starck		40

COLORI TERMOFORMATO DISPONIBILI: NERO MIRAGE 651 ANTRACITE MIRAGE 625 VERDE MIRAGE 426

COLORS OF FABRIC AVAILABLE: BLACK - MIRAGE 651 - DARK GREY - MIRAGE 625 - GREEN - MIRAGE 426

COLORIS DISPONIBLES: NOIR - MIRAGE 651 - GRIS - MIRAGE 625 - VERT - MIRAGE 426

***POSSIBILITÀ DI SELEZIONARE UN ALTRO COLORE DEL TESSUTO MIRAGE PER FORNITURE DI ALMENO 50 PZ**

*IT IS POSSIBLE TO CHOOSE ANOTHER COLOR OF MIRAGE FABRIC FOR ORDERS OF 50 PCS AT LEAST

*POSSIBILITE' DE SELECTIONNER UN AUTRE COLORIS MIRAGE POUR COMMANDE DE QUANTITE' SUPERIEUR AU 50 PC



Omologazione ministeriale al fuoco in classe 1IM con rivestimento PLANET o BINGO ELAST / MIRAGE e poliuretano ignifugo (+6% da listino)

Fireproof Italian Ministry homologation in 1IM class with upholstery PLANET or BINGO ELAST / MIRAGE and fire retardant polyurethane (+6% to price list)

Certification Italienne contre le feu en classe 1IM avec revêtement PLANET ou BINGO ELAST/MIRAGE et polyuréthane ignifuge (+6% sur le tarif)



Ignifugo + extra 6% da listino prezzi

Fireproof + extra 6% to price list

Non feu + extra 6% sur le tarif

Five

EN-1335	EN-1728	EN-1022	CAM
---------	---------	---------	-----



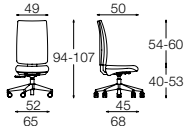
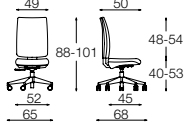
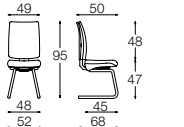
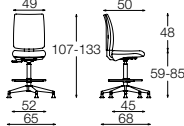

- **Struttura sedile in polipropilene**
Seat structure in polypropylene
Structure assise en polypropylène
- **Imbottitura in poliuretano espanso**
Polyurethane foam padding
Rembourrage en mousse de polyuréthane
- **Struttura schienale in polipropilene nero**
Backrest structure in black polypropylene
Structure dossier en polypropylène

						Pelle Leather Cuir FIESTA	Pelle Leather Cuir NUVOLA	mc	kg
		Cat. F	Cat. G	Cat. S	Cat. TOP	Cat. EXTRA			
<p>SCHIENALE ALTO, minisyncron HIGH BACKREST, mini-syncron DOSSIER HAUT, mini-synchrone</p> <p>FVAMNR01 Senza braccioli Without arms Sans accoudoirs</p> 		239	245	273	278	294	336	387	0.21 14.85
<p>SCHIENALE BASSO, minisyncron LOW BACKREST, mini-syncron DOSSIER BAS, mini-synchrone</p> <p>FVBMNR01 Senza braccioli Without arms Sans accoudoirs</p> 		231	237	262	266	281	319	366	0.21 14.35
<p>SCHIENALE BASSO TELAIO SLITTA verniciato nero LOW BACKREST, CANTILEVER FRAME, black lacquered DOSSIER BAS PIÈTEMENT LUGE peint noir</p> <p>FVBCNR01 Senza braccioli Without arms Sans accoudoirs</p> 		200	206	230	234	248	286	331	0.31 15.15
<p>SGABELLO, con appoggiatesta, minisyncron STOOL, with feet-rest, mini-syncron TABOURET, mini-synchrone, avec repose-pieds</p> <p>FVSMNR01 Senza braccioli Without arms Sans accoudoirs</p> 		284	288	315	318	331	369	415	0.32 16.35

Five

EN-1335	EN-1728	EN-1022	CAM
---------	---------	---------	-----

- **Struttura sedile in polipropilene**
Seat structure in polypropylene
Structure assise en polypropylène
- **Imbottitura poliuretano espanso**
Polyurethane foam padding
Rembourrage en mousse de polyuréthane
- **Struttura schienale in polipropilene nero**
Backrest structure in black polypropylene
Structure dossier en polypropylène

Accessori / Accessories / Accessoires			Prezzo unitario € Unit price € Prix Unitaire €
FVBRFN10	Coppia braccioli fissi neri Black fixed pair of arms Pair d'accoudoirs fixes noir		31
FTBR1DNR	Coppia braccioli regolabili neri 1d 1d black adjustable pair of arms Pair d'accoudoirs réglables 1d noir		33
BNBRG	Coppia braccioli regolabili neri 3d Black 3d adjustable pair of arms Pair d'accoudoirs réglables 3d noir		65
T	Traslatore Slide system Translation assistée		42
AL	Base alluminio Aluminium base Piètement en aluminium		49

Consumi tessuto / Consumption fabric / Tissu nécessaire **ml 0,85**

Consumi pelle / Consumption leather / Cuir nécessaire **mq 1,45**



Omologazione ministeriale al fuoco in classe 1IM con rivestimento PLANET o BINGO ELAST / MIRAGE e poliuretano ignifugo (+6% da listino)

Fireproof Italian Ministry homologation in 1IM class with upholstery PLANET or BINGO ELAST / MIRAGE and fire retardant polyurethane (+6% to price list)

Certification Italienne contre le feu en classe 1IM avec revêtement PLANET ou BINGO ELAST/MIRAGE et polyuréthane ignifuge (+6% sur le tarif)



Ignifugo + extra 6% da listino prezzi

Fireproof + extra 6% to price list

Non feu + extra 6% sur le tarif

Goal

EN-1335

CAM

- **Struttura sedile in polipropilene**
Seat structure in polypropylene
Structure assise en polypropylène
- **Imbottitura in poliuretano espanso**
Seat padding in polyurethane foam
Rembourrage en mousse de polyuréthane
- **Struttura schienale in polipropilene nero**
Backrest structure in black polypropylene
Structure dossier en polypropylène

	Cat. F	Cat. G	Cat. S	Cat. TOP	Cat. EXTRA	Pelle Leather Cuir FIESTA	Pelle Leather Cuir NUVOLA	mc	kg
SCHIENALE IN RETE, regolazione gas sincron autopessante MESH BACKREST, self-weight adjustment synchron DOSSIER EN RESILLE, synchrone avec auto-réglage du poids									
GOBSRNR01 Senza braccioli Without arms Sans accoudoirs	330	332	345	347	356	368	389	0.24	16.35
SCHIENALE IMBOTTITO, retroschienale plastica, regolazione gas sincron autopessante PADDED BACKREST, plastic back cover, self-weight adjustment synchron DOSSIER TAPISSE, part arrière plastic noir, synchrone avec auto-réglage du poids									
GOBSPNR01 Senza braccioli Without arms Sans accoudoirs	343	348	377	381	403	436	485	0.24	18.75

Accessori / Accessories / Accessoires	Prezzo unitario € Unit price € Prix Unitaire €	
FVBRFN10 Coppia braccioli fissi neri Black fixed pair of arms Pair d'accoudoirs fixes noir		31
FTBR1DNR Coppia braccioli regolabili neri 1d 1d black adjustable pair of arms Pair d'accoudoirs réglables 1d noir		33
BNBRG Coppia braccioli regolabili neri 3d Black 3d adjustable pair of arms Pair d'accoudoirs réglables 3d noir		65
GOPT Poggiatesta nero imbottito e rivestito Padded and upholstered headrest Appuie-tête noir, revêtu		66
T Traslatore Slide system Translation assistée		42
AL Base alluminio Aluminium base Piètement en aluminium		49

PER I COLORI DISPONIBILI DELLE RETI, VEDERE LA CARTELLA RIVESTIMENTI "RETI GOAL"

COLORS OF MESH AVAILABLE IN OUR UPHOLSTERY CHART: "RETI GOAL"

RESILLES DISPONIBLES: VOIR "RETI GOAL"

Consumi schienale rete tessuto / Mesh back consumption fabric / Tissu nécessaire dossier resille **ml 0,70**

Consumi schienale rete pelle / Mesh back consumption leather / Cuir nécessaire dossier resille **mq 0,80**

Consumi retro plastica tessuto / Polypropylene back consumption fabric / Tissu nécessaire arriere plastique **ml 0,90**

Consumi retro plastica pelle / Polypropylene back consumption leather / Cuir nécessaire assiere plastique **mq 1,30**



Omologazione ministeriale al fuoco in classe 1IM con rivestimento PLANET o BINGO ELAST / MIRAGE e poliuretano ignifugo (+6% da listino)

Fireproof Italian Ministry homologation in 1IM class with upholstery PLANET or BINGO ELAST / MIRAGE and fire retardant polyurethane (+6% to price list)

Certification Italienne contre le feu en classe 1IM avec revêtement PLANET ou BINGO ELAST/MIRAGE et polyuréthane ignifuge (+6% sur le tarif)



Ignifugo + extra 6% da listino prezzi

Fireproof + extra 6% to price list

Non feu + extra 6% sur le tarif

Hop

EN-1335

- **Struttura sedile in polipropilene**
Seat structure in polypropylene
Structure en polypropylène
- **Sedile imbottito in poliuretano espanso**
Polyurethane foam padding
Rembourrage en mousse de polyuréthane
- **Struttura schienale in polipropilene**
Backrest structure in polypropylene
Structure dossier en polypropylène

	Cat. F	Cat. G	Cat. S	Cat. TOP	Cat. EXTRA	Pelle Leather Cuir FIESTA	Pelle Leather Cuir NUVOLA	mc	kg
SCHIENALE IN RETE, base 5 razze in polipropilene nero, minisyncron MESH-NET BACKREST, black nylon 5 star base, mini-synchro REVETEMENT EN RESILLE, piétement 5 rayons en polypropylène noir, minisynchrone									
HORMNR01 Senza braccioli Without arms Sans accoudoirs	249	252	263	265	276	297	313	0.21	13.9

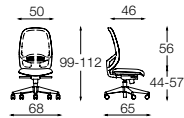

Accessori / Accessories / Accessoires		Prezzo unitario € Unit price € Prix Unitaire €	
ZPBFN12	Coppia braccioli fissi neri a T Black fixed pair of arms t shape Paire d'accoudoirs fixes noir a T		27
FVBRFN10	Coppia braccioli fissi neri Black fixed pair of arms loop shape Paire d'accoudoirs fixes noir		31
FTBR1DNR	Coppia braccioli regolabili neri 1D 1D black adjustable pair of arms Paire d'accoudoirs réglables 1D		33
BNBRG	Coppia braccioli regolabili neri 3D 3D black adjustable pair of arms Paire d'accoudoirs réglables 3D		65
AL	Base alluminio Aluminium base Piétement en aluminium poli		49

RETI DISPONIBILI: RETI GOAL

MESH TO APPLY: GOAL MESHES

RESILLES DISPONIBLES: RESILLES GOAL



Omologazione ministeriale al fuoco in classe 1IM con rivestimento PLANET o BINGO ELAST / MIRAGE e poliuretano ignifugo (+6% da listino)

Fireproof Italian Ministry homologation in 1IM class with upholstery PLANET or BINGO ELAST / MIRAGE and fire retardant polyurethane (+6% to price list)

Certification ministérielle contre le feu en classe 1IM avec revêtement PLANET ou BINGO ELAST / MIRAGE et polyuréthane ignifuge (+ 6% à partir de la liste de prix)



Ignifugo + extra 6% da listino prezzi







Fireproof + extra 6% to price list

Non feu + extra 6% sur le tarif

Lead

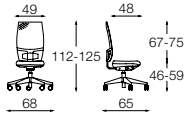
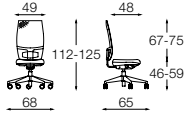
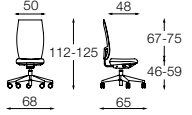
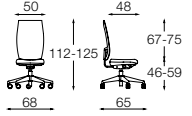
EN-1335









- **Struttura sedile in multistrato di faggio**
Seat structure in multilayer beech wood
Structure assise en hêtre
- **Imbottitura in poliuretano espanso**
Polyurethane foam padding
Rembourrage en mousse de polyuréthane
- **Struttura schienale in polipropilene**
Backrest structure in polypropylene
Structure dossier en polypropylène

						Pelle Leather Cuir FIESTA	Pelle Leather Cuir NUVOLA	 mc	 kg		
SCHIENALE IN RETE, plastiche antracite, sincron autopessante MESH BACKREST, dark grey plastics, self-weight adjustment synchron DOSSIER EN RESILLE, plastic anthracite, synchrone avec auto-réglage du poids											
LESRAAN01	Base antracite, senza braccioli Dark grey base, without arms Piètement en nylon anthracite, sans accoudoirs		344	346	361	363	374	394	415	0.33	16.7
SCHIENALE IN RETE, plastiche nere, sincron autopessante MESH BACKREST, black plastics, self-weight adjustment synchron DOSSIER EN RESILLE, plastic noir, synchrone avec auto-réglage du poids											
LESRRNR01	Base nera, senza braccioli Black base, without arms Piètement en nylon noir, sans accoudoirs		344	346	361	363	374	394	415	0.33	16.7
SCHIENALE IMBOTTITO, plastiche antracite, sincron autopessante PADDED BACKREST, dark grey plastics, self-weight adjustment synchron DOSSIER TAPISSE', plastic anthracite, synchrone avec auto-réglage du poids											
LESIAAN01	Base antracite, senza braccioli Dark grey base, without arms Piètement en nylon anthracite, sans accoudoirs		388	397	436	443	472	518	571	0.33	17.8
SCHIENALE IMBOTTITO, plastiche nere, sincron autopessante PADDED BACKREST, black plastics, self-weight adjustment synchron DOSSIER TAPISSE', plastic noir, synchrone avec auto-réglage du poids											
LESINNR01	Base nera, senza braccioli Black base, without arms Piètement en nylon noir, sans accoudoirs		388	397	436	443	472	518	571	0.33	17.8
Accessori / Accessories / Accessoires						Prezzo unitario €					
						Unit price €					
						Prix Unitaire €					
LESPLN	Supporto lombare regolabile in altezza/profondità per schienale rete Lumbar support adjustable in height/depth for mesh backrest Support lombaire réglable en hauteur/profondeur pour dossier en resille										
LEPTRG	Poggiatesta antracite in rete Meshnet headrest, anthracite finish Appuie-tête anthracite en resille										
LEPTRN	Poggiatesta nero in rete Meshnet headrest, black finish Appuie-tête noir en resille										
LEPTIGR	Poggiatesta antracite imbottito e rivestito Padded and upholstered headrest, anthracite finish Appuie-tête anthracite rembourré et tapissé										

Lead

EN-1335

- **Struttura sedile in multistrato di faggio**
Seat structure in multilayer beech wood
Structure assise en hêtre
- **Imbottitura in poliuretano espanso**
Polyurethane foam padding
Rembourrage en mousse de polyuréthane
- **Struttura schienale in polipropilene**
Backrest structure in polypropylene
Structure dossier en polypropylène

Accessori / Accessories / Accessoires			Prezzo unitario € Unit price € Prix Unitaire €
LEPTINR	Poggiatesta nero imbottito e rivestito Padded and upholstered headrest, black finish Appuie-tête noir rembourré et tapissé		68
FVBRFN10	Coppia braccioli fissi neri Black fixed pair of arms Pair d'accoudoirs fixes noir		31
FTBR1DNR	Coppia braccioli regolabili neri 1d 1d black adjustable pair of arms Pair d'accoudoirs réglables 1d noir		33
FTBR1DCN	Coppia braccioli regolabili neri 1d cromo 1d black adjustable pair of arms, chromed Pair d'accoudoirs réglables 1d noir, chromé		55
LEBR2DGA	Coppia braccioli regolabili 2d antracite 2d dark grey adjustable pair of arms Pair d'accoudoirs réglables 2d anthracite		60
BNBRG	Coppia braccioli regolabili neri 3d Black 3d adjustable pair of arms Pair d'accoudoirs réglables 3d noir		65
T	Traslatore Slide system Translation assistée		42
AL	Base alluminio Aluminium base Piètement en aluminium		49
RF	Ruote forate Castors with holes Roulettes avec trous gris/noir		35

PER I COLORI DISPONIBILI DELLE RETI, VEDERE LA CARTELLA RIVESTIMENTI "RETI GOAL"

COLORS OF MESH AVAILABLE IN OUR UPHOLSTERY CHART: "RETI GOAL"
RESILLES DISPONIBLES: VOIR "RETI GOAL"

Consumi sedile rivestito tessuto / Consumption padded seat fabric / Tissu nécessaire assise revetue **ml 0,60**

Consumi sedile rivestito pelle / Consumption padded seat leather / Cuir nécessaire assise revetue **mq 0,80**

Consumi schienale e sedile rivestiti tessuto / Consumption back and seat upholstered fabric / Tissu nécessaire dossier et assise revetus **ml 0,90**

Consumi schienale e sedile rivestiti pelle / Consumption back and seat upholstered leather / Cuir nécessaire dossier et assise revetus **mq 1,45**



Omologazione ministeriale al fuoco in classe 1IM con rivestimento PLANET o BINGO ELAST / MIRAGE e poliuretano ignifugo (+6% da listino)

Fireproof Italian Ministry homologation in 1IM class with upholstery PLANET or BINGO ELAST / MIRAGE and fire retardant polyurethane (+6% to price list)
Certification Italienne contre le feu en classe 1IM avec revêtement PLANET ou BINGO ELAST/MIRAGE et polyuréthane ignifuge (+6% sur le tarif)



Ignifugo + extra 6% da listino prezzi

Fireproof + extra 6% to price list
Non feu + extra 6% sur le tarif

Skin mesh

EN-1335

EN-1728

EN-1022

CAM

- **Struttura sedile in polipropilene**
Seat structure in polypropylene
Structure assise en polypropylène
- **Sedile imbottito in poliuretano espanso**
Polyurethane foam padding
Rembourrage en mousse de polyuréthane
- **Struttura schienale in polipropilene**
Backrest structure in polypropylene
Structure dossier en polypropylène

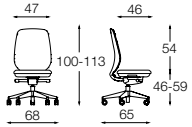
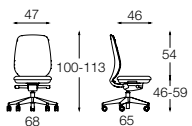
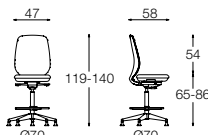
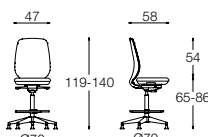
	Cat. F	Cat. G	Cat. S	Cat. TOP	Cat. EXTRA	Pelle Leather Cuir FIESTA	Pelle Leather Cuir NUVOLA	mc	kg
SCHIENALE RETE, supporto lombare, sincron autopessante MESH BACKREST, lumbar support, self-weight adjustment synchron DOSSIER EN RESILLE, support lombaire, synchrone avec auto-réglage du poids									
SKKPNRRSNR Plastiche nere, senza braccioli Black plastic, without arms Plastique noir, sans accoudoirs									
	302	307	331	339	355	403	440	0.18	16
SKKPBRSBC Plastiche bianche, senza braccioli White plastic, without arms Plastique blanc, sans accoudoirs									
	325	331	354	363	378	426	463	0.18	16
SCHIENALE RETE, sgabello, supporto lombare, sincron autopessante MESH BACKREST, stool, lumbar support, self-weight adjustment synchron DOSSIER EN RESILLE, tabouret, support lombaire, synchrone avec auto-réglage du poids									
SKKNRRSNR Plastiche nere, senza braccioli Black plastic, without arms Plastique noir, sans accoudoirs									
	357	362	386	394	410	458	495	0.18	18
SKKBRSBC Plastiche bianche, senza braccioli White plastic, without arms Plastique blanc, sans accoudoirs									
	380	386	409	418	433	481	518	0.18	18

PER I COLORI DISPONIBILI DELLE RETI, VEDERE LA CARTELLA RIVESTIMENTI "RETI GOAL"

COLORS OF MESH AVAILABLE IN OUR UPHOLSTERY CHART: "RETI GOAL"

RESILLES DISPONIBLES: VOIR "RETI GOAL"

Consumi sedile rivestito tessuto / Consumption padded seat fabric / Tissu nécessaire assise revetue **ml 0,60**

Consumi sedile rivestito pelle / Consumption padded seat leather / Cuir nécessaire assise revetue **mq 0,80**



Ignifugo + extra 6% da listino prezzi

Fireproof + extra 6% to price list

Non feu + extra 6% sur le tarif

Skin

EN-1335	EN-1728	EN-1022	CAM
---------	---------	---------	-----

- **Struttura sedile in polipropilene**
Seat structure in polypropylene
Structure assise en polypropylène
- **Schienale e sedile imbottito in poliuretano espanso**
Polyurethane foam padding
Rembourrage en mousse de polyuréthane
- **Struttura schienale in polipropilene**
Backrest structure in polypropylene
Structure dossier en polypropylène

	Cat. F	Cat. G	Cat. S	Cat. TOP	Cat. EXTRA	Pelle Leather Cuir FIESTA	Pelle Leather Cuir NUVOLA	mc	kg
SCHIENALE IMBOTTITO, supporto lombare, sincron autopesante PADDED BACKREST, lumbar support, self-weight adjustment synchron DOSSIER TAPISSE', support lombaire, synchrone avec auto-réglage du poids									
SKKPNRISNR Plastiche nere, senza braccioli Black plastic, without arms Plastique noir, sans accoudoirs		317	322	346	354	370	418	455	0.18 18
SKKPBICISBC Plastiche bianche, senza braccioli White plastic, without arms Plastique blanc, sans accoudoirs		340	346	369	377	393	441	478	0.18 18
SCHIENALE IMBOTTITO, sgabello, supporto lombare, sincron autopesante PADDED BACKREST, stool, lumbar support, self-weight adjustment synchron DOSSIER TAPISSE', tabouret, support lombaire, synchrone avec auto-réglage du poids									
SKKNRISNR Plastiche nere, senza braccioli Black plastic, without arms Plastique noir, sans accoudoirs		372	377	401	409	425	473	510	0.18 20
SKKBICISBC Plastiche bianche, senza braccioli White plastic, without arms Plastique blanc, sans accoudoirs		395	401	424	432	448	496	533	0.18 20

Consumi schienale e sedile rivestiti tessuto / Consumption back and seat upholstered fabric / Tissu nécessaire dossier et assise revetus **ml 0,80**

Consumi schienale e sedile rivestiti pelle / Consumption back and seat upholstered leather / Cuir nécessaire dossier et assise revetus **mq 1,25**













Omologazione ministeriale al fuoco in classe 1IM con rivestimento PLANET o BINGO ELAST / MIRAGE e poliuretano ignifugo (+6% da listino)
Fireproof Italian Ministry homologation in 1IM class with upholstery PLANET or BINGO ELAST / MIRAGE and fire retardant polyurethane (+6% to price list)
Certification Italienne contre le feu en classe 1IM avec revêtement PLANET ou BINGO ELAST/MIRAGE et polyuréthane ignifuge (+6% sur le tarif)





Ignifugo + extra 6% da listino prezzi
Fireproof + extra 6% to price list
Non feu + extra 6% sur le tarif

Skin

- **Struttura sedile in polipropilene**
Seat structure in polypropylene
Structure assise en polypropylène
- **Schienale e sedile imbottito in poliuretano espanso**
Polyurethane foam padding
Rembourrage en mousse de polyuréthane
- **Struttura schienale in polipropilene**
Backrest structure in polypropylene
Structure dossier en polypropylène

Accessori / Accessories / Accessoires			Prezzo unitario € Unit price € Prix Unitaire €
FVBRFN10	Coppia braccioli fissi neri Black fixed pair of arms Pair d'accoudoirs fixes noir		31
FVBRFB10	Coppia braccioli fissi bianchi White fixed pair of arms Pair d'accoudoirs fixes blanc		33
FTBR1DNR	Coppia braccioli regolabili neri 1d 1d black adjustable pair of arms Pair d'accoudoirs réglables 1d noir		33
FTBR1DBC	Coppia braccioli regolabili bianchi 1d 1d white adjustable pair of arms Pair d'accoudoirs réglables 1d blanc		35
BNBRG	Coppia braccioli regolabili neri 3d Black 3d adjustable pair of arms Pair d'accoudoirs réglables 3d noir		65
GOPT	Appoggiatesta nero imbottito e rivestito Black headrest, padded and upholstered Appuie-tête noir, revêtu		66
GOPTB	Appoggiatesta bianco imbottito e rivestito White headrest, padded and upholstered Appuie-tête blanc, revêtu		72
T	Traslatore Slide system Translation assise		42
AL	Base alluminio Aluminium base Piètement en aluminium		49
RF	Ruote forate grigie Castors with holes Roulettes avec trous		35
RF__	Ruote forate bianche (BC) o nere (NR) - design Philippe Starck White (BC) or BLACK (NR) castors with holes - design Philippe Starck Roulettes avec trous blanc (BC) ou noir (NR) - design Philippe Starck		40

- **Base polipropilene nero e colonna in acciaio**
Black polypropylene structure
Piètement en polypropylène noir et colonne en acier
- **Imbottitura in poliuretano espanso**
Polyurethane foam padding
Rembourrage en mousse de polyuréthane
- **Scocca in multistrato di faggio**
Shell in multilayer beech wood
Coque en bois multiplis

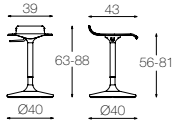
	Cat. F	Cat. G	Cat. S	Cat. TOP	Cat. EXTRA	Pelle Leather Cuir FIESTA	Pelle Leather Cuir NUVOLA	 mc	 kg
SEDUTA DINAMICA - Base oscillante ACTIVE STOOL - Oscillating base TABOURET DYNAMIQUE - base oscillant									
OBGONR 	323	328	345	348	358	377	394	0.11	8.05

Consumi tessuto / Consumption fabric / Tissu nécessaire **mq 0,60**
Consumi pelle / Consumption leather / Cuir nécessaire **mq 0,70**



Omologazione ministeriale al fuoco in classe 1IM con rivestimento PLANET o BINGO ELAST / MIRAGE e poliuretano ignifugo (+6% da listino)
 Fireproof Italian Ministry homologation in 1IM class with upholstery PLANET or BINGO ELAST / MIRAGE and fire retardant polyurethane (+6% to price list)
 Certification Italienne contre le feu en classe 1IM avec revêtement PLANET ou BINGO ELAST/MIRAGE et polyuréthane ignifuge (+6% sur le tarif)



Ignifugo + extra 6% da listino prezzi
 Fireproof + extra 6% to price list
 Non feu + extra 6% sur le tarif

“Gli spazi dedicati alle attività di piccoli gruppi quali progetti, discussioni, lettura o scrittura; formazione e insegnamento vanno ripensati; l’arredo deve essere facile da ricombinare ed estremamente flessibile trasformandoli in incubatori di nuove idee, favorendo la percezione di una cultura condivisa.”

Collettività

Community chairs / Chaises de collectivité

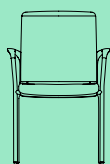

HOST

48

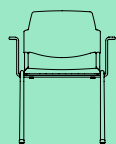

NEW
BONN

50

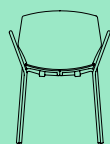

NO
FRILL

56



NUKE

57

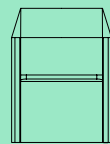

ORIGAMI

58

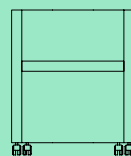

PASS

59

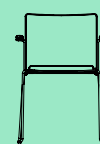

SLIM

60



SOCIAL

63

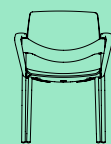

SUNNY
NEW

64

“Small group spaces for activities such as projects, meetings, reading or writing; education and training need to be rethought; furnishings need to be flexible and easy to reconfigure flexible so that they can become breeding grounds for new ideas stemming from a shared culture.”

Host

EN 16139

EN-1728

EN-1022

- **Struttura telaio portante in metallo**
Metal frame
Structure portante en métal
- **Imbottitura poliuretano espanso**
Polyurethane foam padding
Rembourrage en mousse de polyuréthane
- **Schienale in rete**
Mesh backrest
Dossier en resille

			Cat. F	Cat. G	Cat. S	Cat. TOP	Cat. EXTRA	Pelle Leather Cuir FIESTA	Pelle Leather Cuir NUVOLA	mc	kg	
SEDIA, schienale in rete, con braccioli CHAIR, mesh backrest, with arms CHAISE, dossier en resille, avec accoudoirs												
HSNRNQCR	Plastiche e rete nera, telaio 4 gambe cromato Black plastics and mesh, 4 legs chromed frame Structure et resille noir, piètment 4 pieds chromé		290	295	305	310	320	360	375	0.38	9	max 3 pz 3 pcs 3 pc
HSBRBQCR	Plastiche e rete bianca, telaio 4 gambe cromato White plastics and mesh, 4 legs chromed frame Structure et resille blanc, piètment 4 pieds chromé		315	320	330	335	345	385	400	0.38	9	max 3 pz 3 pcs 3 pc
HSNRNCCR	Plastiche e rete nera, telaio slitta cromato Black plastics and mesh, cantilever chromed frame Structure et resille noir, piètment luge chromé		290	295	305	310	320	360	375	0.38	9	max 3 pz 3 pcs 3 pc
HSBRBCCR	Plastiche e rete bianca, telaio slitta cromato White plastics and mesh, cantilever chromed frame Structure et resille blanc, piètment luge chromé		315	320	330	335	345	385	400	0.38	9	max 3 pz 3 pcs 3 pc
HSNRN4NR	Plastiche e rete nera, telaio 4 razze polipropilene nero Black plastics and mesh, swivel black polypropylene frame Structure et resille noir, piètment 4 rayons poly noir		310	315	325	330	340	375	395	0.24	8	
HSBRB4BC	Plastiche e rete bianca, telaio 4 razze polipropilene bianco White plastics and mesh, swivel white polypropylene frame Structure et resille noir, piètment 4 rayons poly blanc		340	345	355	360	370	405	425	0.24	8	
HSNRNPNR	Plastiche e rete nera, elevazione a gas, base 5 razze nera Black plastics and mesh, gaslift and 5-star black base Structure et resille noir, gaz et piètment 5 rayons poly noir		290	295	305	310	320	360	375	0.24	9	
HSBRBPBC	Plastiche e rete bianca, elevazione a gas, base 5 razze bianca White plastics and mesh, gaslift and 5-star white base Structure et resille noir, gaz et piètment 5 rayons poly blanc		325	330	340	345	355	395	410	0.24	9	

A RICHIESTA DISPONIBILE CON TELAIO NERO, STESSO PREZZO

BLACK FRAME AVAILABLE, PRICE DOES NOT CHANGE

PIÈTMENT NOIR DISPONIBLE, MÊME PRIX

Consumi tessuto / Consumption fabric / Tissu nécessaire ml 0,70

Consumi pelle / Consumption leather / Cuir nécessaire mq 1,00



Omologazione ministeriale al fuoco in classe 11M con rivestimento PLANET o BINGO ELAST / MIRAGE e poliuretano ignifugo (+6% da listino) IN CORSO

Fireproof Italian Ministry homologation in 11M class with upholstery PLANET or BINGO ELAST / MIRAGE and fire retardant polyurethane (+6% to price list) ONGOING

Certification Italienne contre le feu en classe 11M avec revêtement PLANET ou BINGO ELAST/MIRAGE et polyuréthane ignifuge (+6% sur le tarif) EN COURS



Ignifugo + extra 6% da listino prezzi

Fireproof + extra 6% to price list



Non feu + extra 6% sur le tarif

Host

EN 16139

EN-1728



EN-1022

Accessori / Accessories / Accessoires			Prezzo unitario € Unit price € Prix Unitaire €
AL	Base alluminio Aluminium base Piètement en aluminium		49
RF	Ruote forate grigie Castors with holes Roulettes avec trous		35
RF__	Ruote forate bianche (BC) o nere (NR) - design Philippe Starck White (BC) or BLACK (NR) castors with holes - design Philippe Starck Roulettes avec trous blanc (BC) ou noir (NR) - design Philippe Starck		40

New Bonn

EN-1728	EN-1022	EN 16139	CAM
---------	---------	----------	-----

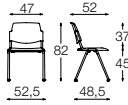
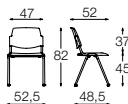

- **Struttura telaio portante in metallo**
Metal frame
Structure portante en métal
- **Imbottitura poliuretano espanso**
Polyurethane foam padding
Rembourrage en mousse de polyuréthane
- **Interni in polipropilene**
Polypropylene inner
Structure intérieure en polypropylène

			Prezzo unitario € Unit price € Prix Unitaire €				
			mc	kg			
SEDIA IN POLIPROPILENE, telaio 4 gambe POLYPROPYLENE CHAIR, 4 legs frame CHAISE EN POLYPROPYLENE, piètement 4 pieds							
NBP_P_4NR	Senza braccioli, telaio nero Without arms, black frame Sans accoudoirs, piètement noir		94	0.27	7.45	max 20 pz 20 pcs 20 pc	
NBP_P_4CR	Senza braccioli, telaio cromato Without arms, chromed frame Sans accoudoirs, piètement chromé		106	0.27	7.45	max 20 pz 20 pcs 20 pc	

COLORI PLASTICHE DISPONIBILI: *ANTRACITE (AN) RAL 7040, *BIANCO (B) RAL 9003, *BLU (U) PANT. 294C, GRIGIO (G) RAL 7024, NERO (N), *ROSSO (R) PANT. 201C
AVAILABLE COLOURS: *DARK GREY (AN) RAL 7040, *WHITE (B) RAL 9003, *BLUE (U) PANT. 294C, GREY (G) RAL 7024, BLACK (N), *RED (R) PANT. 201C
COLORIS PLASTIQUES DISPONIBLES: *ANTHRACITE (AN) RAL 7040, *BLANC (B) RAL 9003, *BLUE (U) PANT. 294C, GRIS (G) RAL 7024, NOIR (N), *ROUGE (R) PANT. 201C

* **COLORI DISPONIBILI SOLO NELLA VERSIONE TUTTA POLIPROPILENE**
* COLORS AVAILABLE ONLY ON FULL POLYPROPYLENE CHAIR
* COLORIS DISPONIBLES SEULEMENT POUR LA VERSION TOTALEMENT POLYPROPYLENE

A RICHIESTA PLASTICHE IGNIFUGHE CLASSE 1 NEI COLORI: NERO E GRIGIO CHIARO + 25% DA LISTINO
FIRE RETARDANT PLASTICS AVAILABLE IN BLACK AND LIGHT GREY COLOR: +25% TO PRICELIST
SUR DEMANDE PLASTIQUES IGNIFUGES DANS LE COLORIS NOIR OU GRIS CLAIR: +25% SUR TARIF

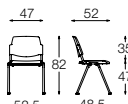
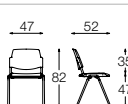
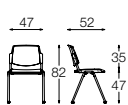
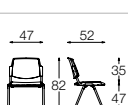
			Cat. F	Cat. G	Cat. S	Cat. TOP	Cat. EXTRA	Pelle Leather Cuir FIESTA	Pelle Leather Cuir NUVOLO			
			mc	kg								
SEDIA, SCHIENALE IN POLIPROPILENE SEDILE IMBOTTITO, telaio 4 gambe POLYPROPYLENE BACK AND SEAT PADDED CHAIR, 4 legs frame CHAISE, DOSSIER EN POLYPROPYLENE ASSISE REVETUE, piètement 4 pieds												
NBP_I_4NR	Plastiche GRIGIE (G) o NERE (N), senza braccioli, telaio nero GREY (G) or BLACK (N) plastics, without arms, black frame Plastique GRIS (G) ou NOIR (N), sans accoudoirs, piètement noir		138	140	152	156	170	-	-	0.27	8.15	max 12 pz 12 pcs 12 pc
NBP_I_4CR	Plastiche GRIGIE (G) o NERE (N), senza braccioli, telaio cromo GREY (G) or BLACK (N) plastics, without arms, chromed frame Plastique GRIS (G) ou NOIR (N), sans accoudoirs, piètement chromé		150	152	163	168	182	-	-	0.27	8.15	max 12 pz 12 pcs 12 pc
SEDIA, SEDILE E SCHIENALE IMBOTTITI E RIVESTITI, telaio 4 gambe PADDED BACK AND SEAT CHAIR, 4 legs frame CHAISE ASSISE ET DOSSIER REVETUS, piètement 4 pieds												
NBI_I_4NR	Plastiche GRIGIE (G) o NERE (N), senza braccioli, telaio nero GREY (G) or BLACK (N) plastics, without arms, black frame Plastique GRIS (G) ou NOIR (N), sans accoudoirs, piètement noir		154	158	174	181	197	227	289	0.27	8.75	max 12 pz 12 pcs 12 pc
NBI_I_4CR	Plastiche GRIGIE (G) o NERE (N), senza braccioli, telaio cromato GREY (G) or BLACK (N) plastics, without arms, chromed frame Plastique GRIS (G) ou NOIR (N), sans accoudoirs, piètement chromé		163	167	183	193	208	237	301	0.27	8.75	max 12 pz 12 pcs 12 pc

New Bonn

EN-1728	EN-1022	EN 16139	CAM
---------	---------	----------	-----

- **Struttura telaio portante in metallo**
Metal frame
Structure portante en métal
- **Imbottitura poliuretano espanso**
Polyurethane foam padding
Rembourrage en mousse de polyuréthane
- **Interni in polipropilene**
Polypropylene inner
Structure intérieure en polypropylène

	Cat. F	Cat. G	Cat. S	Cat. TOP	Cat. EXTRA	Pelle Leather Cuir FIESTA	Pelle Leather Cuir NUVOLO	mc	kg	
SEDIA, SCHIENALE IN RETE E SEDILE IMBOTTITO, telaio 4 gambe MESH BACK AND SEAT PADDED CHAIR, 4 legs frame CHAISE, DOSSIER EN RESILLE ET ASSISE REVETUE, piètement 4 pieds										
NBR_I_4NR										
Rete e plastiche GRIGIE (G) o NERE (N), telaio nero GREY (G) or BLACK (N) mesh and plastics, black frame Resille et plastique GRIS (G) ou NOIR (N), piètement noir										
	154	158	174	181	197	227	289	0.27	8.15	max 12 pz 12 pcs 12 pc
NBR_I_4CR										
Rete e plastiche GRIGIE (G) o NERE (N), telaio cromato GREY (G) or BLACK (N) mesh and plastics, chromed frame Resille et plastique GRIS (G) ou NOIR (N), piètement chromé										
	163	167	183	193	208	237	301	0.27	8.15	max 12 pz 12 pcs 12 pc
SEDIA, SCHIENALE IN POLIPROPILENE E SEDILE IMBOTTITO, telaio slitta POLYPROPYLENE BACK AND SEAT PADDED CHAIR, cantilever frame CHAISE, DOSSIER EN POLYPROPYLENE ASSISE REVETUE, piètement luge										
NBP_I_SNR										
Plastiche GRIGIE (G) o NERE (N), telaio nero GREY (G) or BLACK (N) plastics, black frame Plastique GRIS (G) ou NOIR (N), piètement noir										
	186	189	193	198	201	216	225	0.27	9.55	max 3 pz 3 pcs 3 pc
NBP_I_SCR										
Plastiche GRIGIE (G) o NERE (N), telaio cromato GREY (G) or BLACK (N) plastics, chromed frame Plastique GRIS (G) ou NOIR (N), piètement chromé										
	200	202	207	212	215	230	239	0.27	9.55	max 3 pz 3 pcs 3 pc
SEDIA, SCHIENALE E SEDILE IMBOTTITO, telaio slitta PADDED BACK AND SEAT CHAIR, cantilever frame CHAISE ASSISE ET DOSSIER REVETUS, piètement luge										
NBI_I_SNR										
Plastiche GRIGIE (G) o NERE (N), telaio nero GREY (G) or BLACK (N) plastics, black frame Plastique GRIS (G) ou NOIR (N), piètement noir										
	202	205	209	214	219	232	242	0.27	10.15	max 3 pz 3 pcs 3 pc
NBI_I_SCR										
Plastiche GRIGIE (G) o NERE (N), telaio cromato GREY (G) or BLACK (N) plastics, chromed frame Plastique GRIS (G) ou NOIR (N), piètement chromé										
	216	219	223	228	232	246	255	0.27	10.15	max 3 pz 3 pcs 3 pc
SEDIA, SCHIENALE IN RETE E SEDILE IMBOTTITO, telaio slitta MESH BACK AND SEAT PADDED CHAIR, cantilever frame CHAISE, DOSSIER EN RESILLE ET ASSISE REVETUE, piètement luge										
NBR_I_SNR										
Rete e plastiche GRIGIE (G) o NERE (N), telaio nero GREY (G) or BLACK (N) mesh and plastics, black frame Resille et plastique GRIS (G) ou NOIR (N), piètement noir										
	202	205	209	214	219	232	242	0.27	9.55	max 3 pz 3 pcs 3 pc
NBR_I_SCR										
Rete e plastiche GRIGIE (G) o NERE (N), telaio cromato GREY (G) or BLACK (N) mesh and plastics, chromed frame Resille et plastique GRIS (G) ou NOIR (N), piètement chromé										
	216	219	223	228	232	246	255	0.27	9.55	max 3 pz 3 pcs 3 pc

Consumi tessuto / Fabric consumption / Tissu nécessaire ml **0,60**

Consumi pelle / Leather consumption / Cuir nécessaire mq **0,85**



Omologazione ministeriale al fuoco in classe 1IM con rivestimento PLANET o BINGO ELAST / MIRAGE e poliuretano ignifugo (+6% da listino)
Fireproof Italian Ministry homologation in 1IM class with upholstery PLANET or BINGO ELAST / MIRAGE and fire retardant polyurethane (+6% to price list)
Certification Italienne contre le feu en classe 1IM avec revêtement PLANET ou BINGO ELAST/MIRAGE et polyuréthane ignifuge (+6% sur le tarif)



Ignifugo + extra 6% da listino prezzi

Fireproof + extra 6% to price list

Non feu + extra 6% sur le tarif







New Bonn

EN-1728

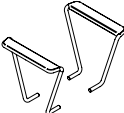
EN-1022

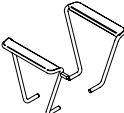
EN 16139

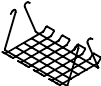
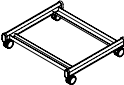

CAM

Accessori / Accessories / Accessoires			Prezzo unitario € Unit price € Prix Unitaire €
NBBRNR_	Coppia braccioli neri Black arms Pair d'accoudoirs noir		36
NBBRCR_	Coppia braccioli cromati Chromed arms Pair d'accoudoirs chromés		38
NBBTNR_	Coppia braccioli per tavoletta neri Pair of arms for writing desk, black Pair d'accoudoirs noir pour tablette		42
NBBTCR_	Coppia braccioli per tavoletta cromati Pair of arms for writing desk, chromed Pair d'accoudoirs cromés pour tablette		45
ISOAT	Tavoletta scrittoio nylon nero Black nylon writing desk Tablette étroite en nylon noir		27
NBAAC	Aggancio corto per sedie senza braccioli Short linking for chairs without arms Crochet court pour chaises sans accoudoirs		7
NBAAL	Aggancio lungo per sedie con braccioli/tavoletta Long linking for chairs with arms/tablet Crochet long pour chaises avec accoudoirs/tablet		14
BONPCE	Cestello Tray Panier		31
BONPCA	Carrello Trolley Chariot		95

New Bonn panca

- **Struttura telaio portante in metallo**
Metal frame
Structure portante en métal
- **Imbottitura poliuretano espanso**
Polyurethane foam padding
Rembourrage en mousse de polyuréthane
- **Interni in polipropilene**
Polypropylene inner
Structure intérieure en polypropylène

EN-1728	EN-1022	EN 16139	CAM
---------	---------	----------	-----

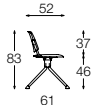
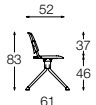
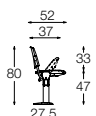
		Prezzo unitario € Unit price € Prix Unitaire €	 mc	 kg
SEDUTA PER PANCA FISSA, IN POLIPROPILENE POLYPROPYLENE BENCH SHELL COQUE POUR POUTRE FIXE, EN POLYPROPYLENE				
NBP_P_PNR	Senza braccioli, telaio nero Without arms, black frame Sans accoudoirs, piètement noir		85	
NBP_P_PCR	Senza braccioli, telaio cromato Without arms, chromed frame Sans accoudoirs, piètement chromé		95	
SEDUTA PER PANCA RIBALTABILE IN POLIPROPILENE POLYPROPYLENE FOLDABLE BENCH SHELL COQUE POUR POUTRE RABATTABLE, EN POLYPROPYLENE				
NBP_P_RNR	Senza braccioli, telaio nero Without arms, black frame Sans accoudoirs, piètement noir		127	

COLORI PLASTICHE DISPONIBILI: *ANTRACITE (AN) RAL 7040, *BIANCO (B) RAL 9003, *BLU (U) PANT. 294C, GRIGIO (G) RAL 7024, NERO (N), *ROSSO (R) PANT. 201C
 AVAILABLE COLOURS: *DARK GREY (AN) RAL 7040, *WHITE (B) RAL 9003, *BLUE (U) PANT. 294C, GREY (G) RAL 7024, BLACK (N), *RED (R) PANT. 201C
 COLORIS PLASTIQUES DISPONIBLES: ANTHRACITE (AN) RAL 7040, BLANC (B) RAL 9003, BLUE (U) PANT. 294C, GRIS (G) RAL 7024, NOIR (N), ROUGE (R) PANT. 201C

*** COLORI DISPONIBILE SOLO NELLA VERSIONE TUTTA POLIPROPILENE**

* COLORS AVAILABLE ONLY ON FULL POLYPROPYLENE CHAIR

* COLORIS DISPONIBILE SEULEMENT POUR LA VERSION TOTALEMENT POLYPROPYLENE

A RICHIESTA PLASTICHE IGNIFUGHE CLASSE 1 NEI COLORI: NERO E GRIGIO CHIARO + 25% DA LISTINO

FIRE RETARDANT PLASTICS AVAILABLE IN BLACK AND LIGHT GREY COLOR: +25% TO PRICELIST

SUR DEMANDE PLASTIQUES IGNIFUGES DANS LE COLORIS NOIR OU GRIS CLAIR: +25% SUR TARIF

New Bonn panca

- **Struttura telaio portante in metallo**
Metal frame
Structure portante en métal
- **Imbottitura poliuretano espanso**
Polyurethane foam padding
Rembourrage en mousse de polyuréthane
- **Interni in polipropilene**
Polypropylene inner
Structure intérieure en polypropylène

EN-1728	EN-1022	EN 16139	CAM
---------	---------	----------	-----

	Cat. F	Cat. G	Cat. S	Cat. TOP	Cat. EXTRA	Pelle Leather Cuir FIESTA	Pelle Leather Cuir NUVOLA	mc	kg	
SEDUTA PER PANCA FISSA, SCHIENALE IN POLIPROPILENE SEDILE IMBOTTITO POLYPROPYLENE BACK AND PADDED SEAT BENCH SHELL COQUE POUR POUTRE FIXE, DOSSIER EN POLYPROPYLENE ASSISE REVETUE										
NBP_I_PNR	138	140	152	156	170	-	-			
Plastiche GRIGIE (G) o NERE (N), telaio nero GREY (G) or BLACK (N) plastics, black frame Plastique GRIS (G) ou NOIR (N), structure noir										
NBP_I_PCR	150	152	163	168	182	-	-			
Plastiche GRIGIE (G) o NERE (N), telaio cromato GREY (G) or BLACK (N) plastics, chromed frame Plastique GRIS (G) ou NOIR (N), structure chromé										
SEDUTA PER PANCA RIBALTABILE SCHIENALE IN POLIPROPILENE E SEDILE IMBOTTITO POLYPROPYLENE BACK AND PADDED SEAT FOLDABLE BENCH SHELL COQUE POUR POUTRE RABATTABLE, DOSSIER EN POLYPROPYLENE ASSISE REVETUE										
NBP_I_RNR	173	175	186	191	205	-	-			
Plastiche GRIGIE (G) o NERE (N), telaio nero GREY (G) or BLACK (N) plastics, black frame Plastique GRIS (G) ou NOIR (N), structure noir										
SEDUTA PER PANCA FISSA, SCHIENALE E SEDILE IMBOTTITI E RIVESTITI PADDED BENCH SHELL COQUE POUR POUTRE FIXE, ASSISE ET DOSSIER REVETUS										
NBI_I_PNR	150	156	171	179	196	225	286			
Plastiche GRIGIE (G) o NERE (N), telaio nero GREY (G) or BLACK (N) plastics, black frame Plastique GRIS (G) ou NOIR (N), structure noir										
NBI_I_PCR	161	166	179	189	205	233	297			
Plastiche GRIGIE (G) o NERE (N), telaio cromato GREY (G) or BLACK (N) plastics, chromed frame Plastique GRIS (G) ou NOIR (N), structure chromé										
SEDUTA PER PANCA RIBALTABILE, SCHIENALE E SEDILE IMBOTTITI E RIVESTITI PADDED FOLDABLE BENCH SHELL COQUE POUR POUTRE RABATTABLE, ASSISE ET DOSSIER REVETUS										
NBI_I_RNR	184	191	206	214	230	260	321			
Plastiche GRIGIE (G) o NERE (N), telaio nero GREY (G) or BLACK (N) plastics, black frame Plastique GRIS (G) ou NOIR (N), structure noir										

Consumi tessuto / Consumption fabric / Tissu nécessaire ml 0,45

Consumi pelle / Consumption leather / Cuir nécessaire mq 0,65



Omologazione ministeriale al fuoco in classe 1IM con rivestimento PLANET o BINGO ELAST / MIRAGE e poliuretano ignifugo (+6% da listino)
Fireproof Italian Ministry homologation in 1IM class with upholstery PLANET or BINGO ELAST / MIRAGE and fire retardant polyurethane (+6% to price list)
Certification Italienne contre le feu en classe 1IM avec revêtement PLANET ou BINGO ELAST/MIRAGE et polyuréthane ignifuge (+6% sur le tarif)



Ignifugo + extra 6% da listino prezzi
Fireproof + extra 6% to price list
Non feu + extra 6% sur le tarif







New Bonn panca

EN-1728

EN-1022

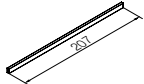
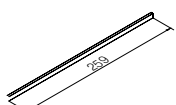
EN 16139



CAM

Accessori / Accessories / Accessoires			Prezzo unitario € Unit price € Prix Unitaire €
BONPT2	Elemento trave 2 p. Two-seater beam Poutre 2 places		37
BONPT3	Elemento trave 3 p. Three-seater beam Poutre 3 places		48
BONPT4	Elemento trave 4 p. Four-seater beam Poutre 4 places		60
BONPT5	Elemento trave 5 p. (consigliabile 3 gambe) Five-seater beam (advisable 3 legs) Poutre 5 places (mettre 3 pieds)		71
BONPGSCR	Elemento term. cromato - Gamba (1 pz) Chromed leg (1 pc) Pied chromé pour poutre (1pc)		61
BONPGSNR	Elemento term. nero - Gamba (1 pz) Black leg (1 pc) Pied noir pour poutre (1pc)		55
NBPGFNR	Elemento term. nero per fissaggio a terra - Gamba (1pz) Black powder coated T leg to be fixed to the floor (1 pc) Pied noir pour fixation au sol (1pc)		40
BONPPA	Piano appoggio nero Black table for bench Table noir pour poutre		66

No Frill

EN 16139

- **Struttura telaio in metallo**
Metal frame structure
Structure en métal
- **Scocca in polipropilene**
Shell in polypropylene
Coque en polypropylène

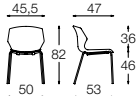
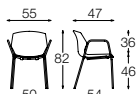
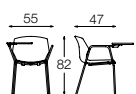
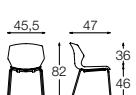
		Prezzo unitario € Unit price € Prix Unitaire €				
		mc	kg			
SEDIA TELAIO 4 GAMBE, senza braccioli CHAIR 4 LEGS FRAME, without arms SIEGE PIÈTEMENT 4 PIEDS, sans accoudoirs						
NFS_4_01	Telaio bianco, antracite, cromato White, dark grey, chromed frame Piètement blanc, anthracite ,chromé		133	0.27	12.25	max 6 pz 6 pcs 6 pc
SEDIA TELAIO 4 GAMBE, con braccioli CHAIR 4 LEGS FRAME, with arms SIEGE PIÈTEMENT 4 PIEDS, avec accoudoirs						
NFS_4_11	Telaio bianco, antracite, cromato White, dark grey, chromed frame Piètement blanc, anthracite ,chromé		169	0.27	14.05	max 6 pz 6 pcs 6 pc
SEDIA TELAIO 4 GAMBE, con braccioli e tavoletta CHAIR 4 LEGS FRAME, with arms and tablet SIEGE PIÈTEMENT 4 PIEDS, avec accoudoirs et tablette écrioire						
NFS_4_11T	Telaio bianco, antracite Dark grey or white frame Piètement anthracite ou blanc		205	0.27	14.05	
SEDIA TELAIO SLITTA CHAIR SLED FRAME SIEGE PIÈTEMENT TRAINEAU						
NFS_C	Telaio bianco, antracite, cromato White, dark grey, chromed frame Piètement blanc, anthracite, chromé		150	0.27	15.65	max 6 pz 6 pcs 6 pc

Accessori / Accessories / Accessoires		Cat. F	Cat. G	Cat. S	Cat. TOP	Cat. EXTRA	Pelle Leather Cuir FIESTA	Pelle Leather Cuir NUVOLA
NFSDRIV	Sedile tappezzato Upholstered seat Assise tapissée							
		42	44	54	56	62	79	92

MINIMO ORDINE 2 PEZZI
 MINIMUM ORDER 2 PCS
 COMMANDE MINIMUM 2 PC

SCocca DISPONIBILE NEI COLORI: ANTRACITE (AN), BIANCO (BC), SABBIA (SB), GIALLO CEDRO (GI), AZZURRO (CE)
 AVAILABLE COLORS: DARK GREY (AN), WHITE (BC), SANDY (SB), YELLOW (GI), SKY BLUE (CE)
 COQUE DISPONIBLES DANS LE COLORIS: ANTHRACITE (AN), BLANC (BC), SABLE (SB), JAUNE (GI), BLUE CLAIR (CE)



Specificare il colore del telaio e il colore delle plastiche
 Specify the color of the frame and the color of the plastics
 Spécifier le coloris du structure et des plastiques

Consumi sedile 1pz rivestito tessuto / Consumption 1pc padded seat fabric / Tissu nécessaire assise 1pc **ml 0,50**
Consumi sedile 1pz rivestito pelle / Consumption 1pc padded seat leather / Cuir nécessaire assise 1pc **mq 0,50**



Omologazione ministeriale al fuoco in classe 1IM con rivestimento PLANET o BINGO ELAST / MIRAGE e poliuretano ignifugo (+6% da listino) - solo per la versione sedile imbottito e rivestito
 Fireproof Italian Ministry homologation in 1IM class with upholstery PLANET or BINGO ELAST / MIRAGE and fire retardant polyurethane (+6% to price list) - only for the padded and upholstered version
 Certification Italienne contre le feu en classe 1IM avec revêtement PLANET ou BINGO ELAST/MIRAGE et polyuréthane ignifuge (+6% sur le tarif) - seulement pour la version avec assise tapissée

EN 16139

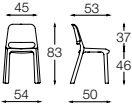
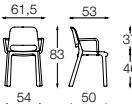
			Prezzo unitario € Unit price € Prix Unitaire €				
			mc	kg			
SEDIA IN POLIPROPILENE 4 GAMBE 4 LEGS CHAIR IN POLYPROPYLENE SIEGE EN POLYETILENE 4 PIEDS							
NU_01	Senza braccioli Without arms Sans accoudoirs		109	0.49	17.6	max 6 pz 6 pcs 6 pc	
NU_11	Con braccioli With arms Avec accoudoirs		122	0.49	19.2	max 6 pz 6 pcs 6 pc	

MINIMO ORDINE 4 PEZZI PER COLORE
 MINIMUM ORDER 4 PCS PER COLOR
 COMMANDE MINIMUM 4 PC POUR COLORIS

DISPONIBILE NEI SEGUENTI COLORI - DA SEGNARE A COMPLETAMENTO NEL CODICE: ARANCIONE (AR), BIANCO (BC), CELESTE (CE)
 AVAILABLE IN DIFFERENT COLORS - TO FILL IN THE CODE: ORANGE (AR), WHITE (BC), SKY BLUE (CE)
 COLORIS DISPONIBLES - A COMPLETER DANS LE CODE: ORANGE (AR), BLANC (BC), BLUE CLAIR (CE)

CARATTERISTICHE DEL MATERIALE: Materiale resistente ai raggi UV, 100% Riciclabile
 CHARACTERISTICS OF THE MATERIAL: Resistant to UV rays, 100% Recyclable
 CARACTERISTIQUES DU MATERIEL: Matériel résistant aux UV, 100% recyclable

Origami

- **Imbottitura in schiumato a freddo**
Padding in injected foam
Rembourrage en mousse moulée à froid
- **Struttura in acciaio**
Steel structure
Structure en acier

			Cat. F	Cat. G	Cat. S	Cat. TOP	Cat. EXTRA	Pelle Leather Cuir FIESTA	Pelle Leather Cuir NUVOLA	mc	kg	
POZZETTO PIEGHEVOLE FOLDABLE TUB CHAIR CHAUFFEUSE PLIABLE												
ORTRPPE	Con piedi With feet Avec pieds		643	663	757	771	840	933	1.088	0.15	18.5	
ORTRPRU	Con ruote With castors Avec roulettes		643	663	757	771	840	933	1.088	0.15	18.5	
ORTRPPET	Con piedi e tavoletta With feet and writing tablet Avec pieds et tablette		691	711	803	819	887	979	1.135	0.15	19	
ORTRPRUT	Con ruote e tavoletta With castors and writing tablet Avec roulettes et tablette		691	711	803	819	887	979	1.135	0.15	19	
Accessori / Accessories / Accessoires							Prezzo unitario € Unit price € Prix Unitaire €					
ORAAG	Aggancio file Link for rows Crochet							24				
ORACAR	Carrello porta poltrone fino a 20 pz Trolley for carrying the chairs up to 20 pcs Chariot, charge max 20 pcs							801				

Consumi poltrona tessuto / Armchair fabric consumption / Tissu nécessaire fauteuil ml 2,80

Consumi poltrona pelle / Armchair leather consumption / Cuir nécessaire fauteuil mq 4,80



Omologazione ministeriale al fuoco in classe 1IM con rivestimento PLANET o BINGO ELAST / MIRAGE e poliuretano ignifugo (+6% da listino)
Fireproof Italian Ministry homologation in 1IM class with upholstery PLANET or BINGO ELAST / MIRAGE and fire retardant polyurethane (+6% to price list)
Certification Italienne contre le feu en classe 1IM avec revêtement PLANET ou BINGO ELAST/MIRAGE et polyuréthane ignifuge (+6% sur le tarif)







Ignifugo + extra 6% da listino prezzi

Fireproof + extra 6% to price list
Non feu + extra 6% sur le tarif

Pass

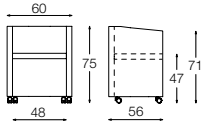
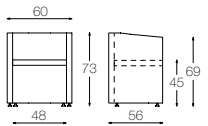
- **Imbottitura poliuretano espanso**
Polyurethane foam padding
Rembourrage en mousse de polyuréthane
- **Struttura interno in legno**
Shell in wood
Coque en bois multiplis

		Cat. F	Cat. G	Cat. S	Cat. TOP	Cat. EXTRA	Pelle Leather Cuir FIESTA	Pelle Leather Cuir NUVOLA	 mc	 kg
TRONETTO TUB CHAIR FAUTEUIL										
PATRRU	Con ruote With castors Avec roulettes		429	446	525	538	753	875	0.33	20.55
PATRPE	Con piedini With feet Avec patins		429	446	525	538	753	875	0.33	20.35
Accessori / Accessories / Accessoires						Prezzo unitario € Unit price € Prix Unitaire €				
SUAT	Tavoletta scrittoio in nylon nero Writing tablet in black nylon Tablette ecriteoire en nylon noir		54							

Consumi tessuto / Consumption fabric / Tissu nécessaire ml 2,30
Consumi pelle / Consumption leather / Cuir nécessaire mq 3,80



Omologazione ministeriale al fuoco in classe 1IM con rivestimento PLANET o BINGO ELAST / MIRAGE e poliuretano ignifugo (+6% da listino)
Fireproof Italian Ministry homologation in 1IM class with upholstery PLANET or BINGO ELAST / MIRAGE and fire retardant polyurethane (+6% to price list)
Certification Italienne contre le feu en classe 1IM avec revêtement PLANET ou BINGO ELAST/MIRAGE et polyuréthane ignifuge (+6% sur le tarif)







Ignifugo + extra 6% da listino prezzi
Fireproof + extra 6% to price list

Slim

- **Struttura telaio in metallo**
Metal frame structure
Structure en métal
- **Scocca in polipropilene**
Shell in polypropylene
Coque en polypropylène

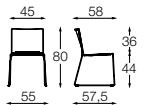
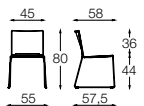
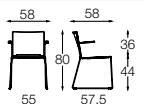
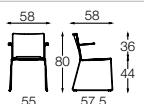
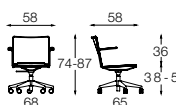
EN-1728	EN-1022	EN 13761	EN 15373
---------	---------	----------	----------

			Prezzo unitario € Unit price € Prix Unitaire €					
			mc	kg				
SEDIA CON TELAIO SLITTA CHAIR WITH SLED FRAME SIEGE PIÈTEMENT TRAINEAU								
SLC__ _01	Telaio bianco o nero, senza braccioli White or black frame, no arms Piètement blanc et noir, sans accoudoirs		120	0.27	8.55	max 20 pz* 20 pcs* 20 pc*		
SLCCR_01	Telaio cromato, senza braccioli Chromed frame, no arms Piètement chromé, sans accoudoirs		131	0.27	8.55	max 20 pz* 20 pcs* 20 pc*		
SLC__ _11	Telaio bianco o nero, con braccioli White or black frame, with arms Piètement blanc et noir, avec accoudoirs		145	0.27	9.05	max 20 pz* 20 pcs* 20 pc*		
SLCCR_11	Telaio cromato, con braccioli Chromed frame, with arms Piètement chromé, avec accoudoirs		163	0.27	9.05	max 20 pz* 20 pcs* 20 pc*		
SEDIA su gas con braccioli CHAIR ON GAS WITH ARMS SIEGE ELEVATION GAZ avec accoudoirs								
SLGCR__ _11	Struttura cromata, base nylon bianca o nera Chromed frame, black or white base Structure chromée, piètement blanc ou noir		259	0.21	11.7			
Accessori / Accessories / Accessoires			Prezzo unitario € Unit price € Prix Unitaire €					
AL	Base alluminio Aluminium base Piètement aluminium		49					

DISPONIBILE NEI COLORI: BIANCO (B), NERO (N), GRIGIO (G) E SABBIA (S)

AVAILABLE COLORS: WHITE (B), BLACK (N), GREY (G) AND SAND (S)
COLORIS DISPONIBLES: BLANC (B), NOIR (N), GRIS (G), SABLE (S)

Specificare dove richiesto il colore del telaio e sempre il colore delle plastiche

Specify where needed the color of the frame and always the color of the plastics
Spécifier le coloris de la structure et des plastiques

A RICHIESTA PLASTICHE IGNIFUGHE CLASSE 2 NEI COLORI: NERO E GRIGIO + 25% DA LISTINO

FIRE RETARDANT CLASS 2 PLASTICS AVAILABLE IN BLACK AND GREY COLOR: +25% TO PRICELIST
SUR DEMANDE PLASTIQUES IGNIFUGES CLASS 2 DANS LE COLORIS NOIR OU GRIS +25% SUR TARIF

*** SLIM IN PLASTICA: impilabile fino a 20 pz a terra - fino a 40 pz su carrello / SLIM SEDILE RIVESTITO: impilabili fino a 15 pz a terra e su trolley**

* SLIM IN POLYPROPYLENE: stackable up to 20 pcs high free standing - up to 40 pcs on trolley / SLIM UPHOLSTERED SEAT: stackable up to 15 high free standing and on trolley

* SLIM EN PLASTIQUE: empilable jusqu'à 20 pc à plat et jusqu'à 40 pc sur chariot / SLIM ASSISE TAPISSEE: empilable jusqu'à 15 pc à plat et sur chariot

Consumi sedile o schienale rivestito tessuto / Consumption padded seat fabric / Tissu nécessaire assise ou dossier revêtu ml 0,60

Consumi sedile o schienale rivestito pelle / Consumption padded seat leather / Cuir nécessaire assise ou dossier revêtu mq 0,80



Omologazione ministeriale al fuoco in classe 11M con rivestimento PLANET o BINGO ELAST / MIRAGE e poliuretano ignifugo (+6% da listino) - solo per la versione imbottita e rivestita

Fireproof Italian Ministry homologation in 11M class with upholstery PLANET or BINGO ELAST / MIRAGE and fire retardant polyurethane (+6% to price list) - only for the padded and upholstered version
Certification Italienne contre le feu en classe 11M avec revêtement PLANET ou BINGO ELAST/MIRAGE et polyuréthane ignifuge (+6% sur le tarif) - seulement pour la version rembourré et tapissé





Ignifugo + extra 6% da listino prezzi



Fireproof + extra 6% to price list
Non feu + extra 6% sur le tarif



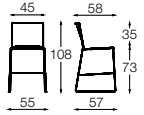

Slim

- **Struttura telaio in metallo**
Metal frame structure
Structure en métal
- **Scocca in polipropilene**
Shell in polypropylene
Coque en polypropylène

EN-1728	EN-1022	EN 13761	EN 15373
---------	---------	----------	----------

		Prezzo unitario € Unit price € Prix Unitaire €				
		mc	kg			
SGABELLO FISSO FIXED STOOL TABOURET FIXE SLS__01		190		0.44	10.85	max 15 pz 15 pcs 15 pc
Telaio cromato (CR) o nero (NR) senza braccioli Chromed (CR) or black (NR) frame, without arms Structure chromée (CR) ou noir (NR), sans accoudoirs						

Accessori / Accessories / Accessoires		Cat. F	Cat. G	Cat. S	Cat. TOP	Cat. EXTRA	Pelle Leather Cuir FIESTA	Pelle Leather Cuir NUVOLA
SLSDRIV	Sedile tappezzato Upholstered seat Assise tapissée		46	48	61	62	87	109
SLSHRIV	Schienale tappezzato Upholstered backrest Dossier tapissé		46	48	61	62	87	109

Accessori / Accessories / Accessoires		Prezzo unitario € Unit price € Prix Unitaire €	
SLTANRS	Tavoletta scrittoio in HPL Writing tablet in HPL Tablette ecritoire en HPL		77
SLACA	Carrello porta sedie Trolley Chariot		535
SLAAC	Aggancio corto per sedie senza braccioli Short linking for chairs without arms Crochet court pour chaises sans accoudoirs		8
SLAAL	Aggancio lungo per sedie con braccioli/tavoletta Long linking for chairs with arms/tablet Crochet long pour chaises avec accoudoirs/tablet		12

DISPONIBILE NEI COLORI: BIANCO (B), NERO (N), GRIGIO (G) E SABBIA (S)

AVAILABLE COLORS: WHITE (B), BLACK (N), GREY (G) AND SAND (S)
COLORIS DISPONIBLES: BLANC (B), NOIR (N), GRIS (G), SABLE (S)

Specificare dove richiesto il colore del telaio e sempre il colore delle plastiche

Specify where needed the color of the frame and always the color of the plastics
Spécifier le coloris de la structure et des plastiques

A RICHIESTA PLASTICHE IGNIFUGHE NEI COLORI: NERO E GRIGIO + 25% DA LISTINO

FIRE RETARDANT PLASTICS AVAILABLE IN BLACK AND GREY COLOR: +25% TO PRICELIST
SUR DEMANDE PLASTIQUES IGNIFUGES CLASS 2 DANS LE COLORIS NOIR OU GRIS +25% SUR TARIF

Consumi sedile o schienale rivestito tessuto / Consumption padded seat or back in fabric / Tissu nécessaire assise ou dossier revêtu ml 0,60

Consumi sedile o schienale rivestito pelle / Consumption padded seat or back in leather / Cuir nécessaire assise ou dossier revêtu mq 0,80



Omologazione ministeriale al fuoco in classe 11M con rivestimento PLANET o BINGO ELAST / MIRAGE e poliuretano ignifugo (+6% da listino) - solo per la versione imbottita e rivestita
Fireproof Italian Ministry homologation in 11M class with upholstery PLANET or BINGO ELAST / MIRAGE and fire retardant polyurethane (+6% to price list) - only for the padded and upholstered version
Certification Italienne contre le feu en classe 11M avec revêtement PLANET ou BINGO ELAST/MIRAGE et polyuréthane ignifuge (+6% sur le tarif) - seulement pour la version rembourrée et tapissée









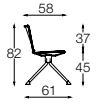

Ignifugo + extra 6% da listino prezzi

Fireproof + extra 6% to price list
Non feu + extra 6% sur le tarif

Slim panca

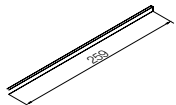
- **Struttura telaio in metallo**
Metal frame structure
Structure en métal
- **Scocca in polipropilene**
Shell in polypropylene
Coque en polypropylène

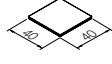
			Prezzo unitario € Unit price € Prix Unitaire €	 mc	 kg
SCocca PER PANCA BENCH SHELL COQUE POUR POUTRE					
SLPCR_01	Struttura cromata Chromed frame Structure chromée		144		
Accessori / Accessories / Accessoires			Prezzo unitario € Unit price € Prix Unitaire €		
BONPT2	Trave 2 posti per panca 2-seater beam for bench Poutre 2 places		37		
BONPT3	Trave 3 posti per panca 3-seater beam for bench Poutre 3 places		48		
BONPT4	Trave 4 posti per panca 4-seater beam for bench Poutre 4 places		60		
BONPT5	Trave 5 posti per panca 5-seater beam for bench Poutre 5 places		71		
BONPGSCR	Gamba cromata per panca (1pz) Chromed leg for bench (1 pc) Pied chromé pour poutre (1 pc)		61		
BONPPA	Tavolino nero d'appoggio per panca Table for the bench Table noir pour poutre		66		

DISPONIBILE NEI COLORI: BIANCO (B), NERO (N), GRIGIO (G) E SABBIA (S)

AVAILABLE COLORS: WHITE (B), BLACK (N), GREY (G) AND SAND (S)

COLORIS DISPONIBLES: BLANC (B), NOIR (N), GRIS (G), SABLE (S)

Specificare dove richiesto il colore del telaio e sempre il colore delle plastiche

Specify where needed the color of the frame and always the color of the plastics

Spécifier le coloris de la structure et des plastiques

A RICHIESTA PLASTICHE IGNIFUGHE NEI COLORI: NERO E GRIGIO + 25% DA LISTINO

FIRE RETARDANT PLASTICS AVAILABLE IN BLACK AND GREY COLOR: +25% TO PRICELIST

SUR DEMANDE PLASTIQUES IGNIFUGES CLASS 2 DANS LE COLORIS NOIR OU GRIS +25% SUR TARIF

Consumi sedile o schienale rivestito tessuto / Consumption padded seat or back in fabric / Tissu nécessaire assise ou dossier revêtu **ml 0,60**

Consumi sedile o schienale rivestito pelle / Consumption padded seat or back in leather / Cuir nécessaire assise ou dossier revêtu **mq 0,80**



Omologazione ministeriale al fuoco in classe 11M con rivestimento PLANET o BINGO ELAST / MIRAGE e poliuretano ignifugo (+6% da listino) - solo per la versione imbottita e rivestita

Fireproof Italian Ministry homologation in 11M class with upholstery PLANET or BINGO ELAST / MIRAGE and fire retardant polyurethane (+6% to price list) - only for the padded and upholstered version

Certification Italienne contre le feu en classe 11M avec revêtement PLANET ou BINGO ELAST/MIRAGE et polyuréthane ignifuge (+6% sur le tarif) - seulement pour la version rembourré et tapissé



Ignifugo + extra 6% da listino prezzi

Fireproof + extra 6% to price list

Non feu + extra 6% sur le tarif

Social

- **Struttura sedile in polipropilene**
Seat structure in polypropylene
Structure assise en polypropylène
- **Imbottitura poliuretano espanso**
Polyurethane foam padding
Rembourrage en mousse de polyuréthane
- **Struttura schienale in polipropilene**
Backrest structure in polypropylene
Structure dossier en polypropylène

			Cat. F	Cat. G	Cat. S	Cat. TOP	Cat. EXTRA	Pelle Leather Cuir FIESTA	Pelle Leather Cuir NUVOLA	mc	kg	
SCHIENALE ALTO IMBOTTITO E RIVESTITO HIGH BACK, UPHOLSTERED AND PADDED DOSSIER HAUT REVETU												
SOAQC11	Telaio 4 gambe cromato Chromed 4 legs frame Piètement 4 pieds chromé		256	265	301	308	336	407	464	0.38	12.45	max 3 pz 3 pcs 3 pc
SOACC11	Telaio slitta cromato Chromed cantilever frame Piètement luge chromé		256	265	301	308	336	407	464	0.38	12.55	max 3 pz 3 pcs 3 pc
SCHIENALE BASSO IN RETE LOW BACK, MESH-NET BACKREST DOSSIER BAS EN RESILLE												
SOBQC11R	Telaio 4 gambe cromato Chromed 4 legs frame Piètement 4 pieds chromé		228	230	244	246	256	267	284	0.33	11.15	max 3 pz 3 pcs 3 pc
SOBCC11R	Telaio slitta cromato Chromed cantilever frame Piètement luge chromé		228	230	244	246	256	267	284	0.33	11.25	max 3 pz 3 pcs 3 pc

PER I COLORI DISPONIBILI DELLE RETI, VEDERE LA CARTELLA RIVESTIMENTI "RETI GOAL" E "RETI FIT"
COLORS OF MESH AVAILABLE IN OUR UPHOLSTERY CHART: "RETI GOAL", "RETI FIT"
RESILLES DISPONIBLES: VOIR "RETI GOAL" E "RETI FIT"

Consumi schienale rivestito tessuto / Consumption padded backrest fabric / Tissu nécessaire dossier revetu **ml 1,20**

Consumi schienale rivestito pelle / Consumption padded backrest leather / Cuir nécessaire dossier revetue **mq 2,20**

Consumi schienale rete tessuto / Mesh back consumption fabric / Tissu nécessaire dossier resille **ml 0,45**

Consumi schienale rete pelle / Mesh back consumption leather / Cuir nécessaire dossier resille **mq 0,60**



Omologazione ministeriale al fuoco in classe 1IM con rivestimento PLANET o BINGO ELAST / MIRAGE e poliuretano ignifugo (+6% da listino)

Fireproof Italian Ministry homologation in 1IM class with upholstery PLANET or BINGO ELAST / MIRAGE and fire retardant polyurethane (+6% to price list)

Certification Italienne contre le feu en classe 1IM avec revêtement PLANET ou BINGO ELAST/MIRAGE et polyuréthane ignifuge (+6% sur le tarif)



Ignifugo + extra 6% da listino prezzi



Fireproof + extra 6% to price list

Non feu + extra 6% sur le tarif

Sunny new

- **Struttura telaio in metallo**
Metal frame structure
Structure en métal
- **Seduta e schienale in polipropilene**
Seat and back in polypropylene
Assise et dossier en polypropylène

EN-1728 EN-1022 EN 16139

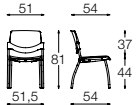
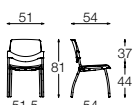
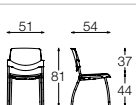
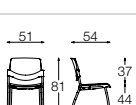
		Prezzo unitario € Unit price € Prix Unitaire €		 mc	 kg	
SCHIENALE E SEDILE IN POLIPROPILENE, telaio 4 gambe POLYPROPYLENE BACKREST AND SEAT, 4 legs frame DOSSIER ET ASSISE POLYPROPYLENE, piètement 4 pieds						
SNPPNTNR01	Telaio nero, plastiche nere Black frame, black plastics Piètement noir, plastique noir		104	0.33	7.25	max 5 pz 5 pcs 5 pc
SNPPNCR01	Telaio cromato, plastiche nere Chromed frame, black plastics Piètement chromé, plastique noir		118	0.33	7.25	max 5 pz 5 pcs 5 pc
SNPPBTR01	Telaio nero, plastiche bianche Black frame, white plastics Piètement noir, plastique blanc		110	0.33	7.25	max 5 pz 5 pcs 5 pc
SNPPBTR01	Telaio cromato, plast. bianche Chromed frame, white plastics Piètement chromé, plastique blanc		124	0.33	7.25	max 5 pz 5 pcs 5 pc

A RICHIESTA PLASTICHE IGNIFUGHE CLASSE 1 NEI COLORI: NERO + 25% DA LISTINO

FIRE RETARDANT PLASTICS AVAILABLE IN BLACK COLOR: +25% TO PRICELIST
SUR DEMANDE PLASTIQUES IGNIFUGES DANS LE COLORIS NOIR: +25% SUR TARIF

Sunny new

EN-1728

EN-1022

EN
16139

- **Struttura sedile in multistrato di faggio**
Structure seat in multilayer beech wood
Structure assise en hêtre
- **Imbottitura poliuretano espanso**
Polyurethane foam padding
Rembourrage en mousse de polyuréthane
- **Struttura schienale in polipropilene**
Backrest structure in polypropylene
Structure dossier en polypropylène

			Cat. F	Cat. G	Cat. S	Cat. TOP	Cat. EXTRA	Pelle Leather Cuir FIESTA	Pelle Leather Cuir NUVOLA	mc	kg	
SCHIENALE E SEDILE IMBOTTITI E RIVESTITI, telaio 4 gambe UPHOLSTERED AND PADDED BACK AND SEAT, 4 legs frame, without arms DOSSIER ET ASSISE TAPISES, piètement 4 pieds												
SNINTNR01	Telaio nero, plastiche nere Black frame, black plastics Piètement noir, plastique noir		165	168	185	193	202	233	278	0.33	8.95	max 5 pz 5 pcs 5 pc
SNINTCR01	Telaio cromato, plastiche nere Chromed frame, black plastics Piètement cromé, plastique noir		171	174	192	200	197	240	285	0.33	8.95	max 5 pz 5 pcs 5 pc
SNIBTNR01	Telaio nero, plastiche bianche Black frame, white plastics Piètement noir, plastique blanc		171	174	192	199	208	239	284	0.33	8.95	max 5 pz 5 pcs 5 pc
SNIBTCR01	Telaio cromato, plastiche bianche Chromed frame, white plastics Piètement cromé, plastique blanc		178	180	198	206	215	246	291	0.33	8.95	max 5 pz 5 pcs 5 pc
SCHIENALE IN POLIPROPILENE, SEDILE RIVESTITO telaio 4 gambe POLYPROPYLENE BACK, UPHOLSTERED SEAT, 4 legs frame, without arms DOSSIER POLYPROPYLENE ET ASSISE TAPISSE, piètement 4 pieds												
SNPNTNR01	Telaio nero, plastiche nere Black frame, black plastics Piètement noir, plastique noir		139	141	151	156	159	174	190	0.33	8.15	max 5 pz 5 pcs 5 pc
SNPNTCR01	Telaio cromato, plastiche nere Chromed frame, black plastics Piètement chromé, plastique noir		157	159	169	174	178	196	211	0.33	8.15	max 5 pz 5 pcs 5 pc
SNPBTNR01	Telaio nero, plastiche bianche Black frame, white plastics Piètement noir, plastique blanc		146	149	157	162	165	180	196	0.33	8.15	max 5 pz 5 pcs 5 pc
SNPBTCR01	Telaio cromato, plastiche bianche Chromed frame, white plastics Piètement chromé, plastique blanc		163	165	175	180	184	202	217	0.33	8.15	max 5 pz 5 pcs 5 pc

A RICHIESTA PLASTICHE IGNIFUGHE CLASSE 1 NEI COLORI: NERO + 25% DA LISTINO

FIRE RETARDANT PLASTICS AVAILABLE IN BLACK COLOR: +25% TO PRICELIST
SUR DEMANDE PLASTIQUES IGNIFUGES DANS LE COLORIS NOIR: +25% SUR TARIF

Consumi schienale rivestito tessuto / Consumption padded backrest fabric / Tissu nécessaire dossier revetu **ml 0,80**

Consumi schienale rivestito pelle / Consumption padded backrest leather / Cuir nécessaire dossier revetue **mq 1,10**

Consumi schienale polipropilene tessuto / Consumption polypropylene backrest fabric / Tissu nécessaire dossier en polypropylène **ml 0,60**

Consumi schienale polipropilene pelle / Consumption polypropylene backrest leather / Cuir nécessaire dossier polypropylène **mq 0,90**



Omologazione ministeriale al fuoco in classe 1IM con rivestimento PLANET o BINGO ELAST / MIRAGE e poliuretano ignifugo (+6% da listino)







Fireproof Italian Ministry homologation in 1IM class with upholstery PLANET or BINGO ELAST / MIRAGE and fire retardant polyurethane (+6% to price list)
Certification Italienne contre le feu en classe 1IM avec revêtement PLANET ou BINGO ELAST/MIRAGE et polyuréthane ignifuge (+6% sur le tarif)



Ignifugo + extra 6% da listino prezzi









Fireproof + extra 6% to price list
Non feu + extra 6% sur le tarif

Sunny new

Accessori / Accessories / Accessoires		Prezzo unitario € Unit price € Prix Unitaire €
SNBRPPNR	<p>Coppia braccioli neri polipropilene Black polypropylene arms Pair d'accoudoirs noir en polypropylène</p> 	32
SNBRPPBC	<p>Coppia braccioli bianchi polipropilene White polypropylene arms Pair d'accoudoirs blanc en polypropylène</p> 	36
SNBRNR	<p>Coppia braccioli neri poliuretano Black polyurethane arms Pair d'accoudoirs noir en polyurethane</p> 	51
SNBRTNR	<p>Coppia braccioli neri in poliuretano per tavoletta Arms in polyurethane for writing desk Pair d'accoudoirs noir en polyurethane pour tablette</p> 	56
SUAT	<p>Tavoletta scrittoio nylon nero Black nylon writing desk Tablette ecritoire en nylon noir</p> 	38
SUAAL	<p>Aggancio lungo Long linking Crochet long</p> 	16

Sunny new panca

- **Struttura telaio portante in metallo**
Metal frame
Structure portante en métal
- **Imbottitura poliuretano espanso**
Polyurethane foam padding
Rembourrage en mousse de polyuréthane
- **Seduta e schienale in polipropilene**
Seat and back in polypropylene
Assise et dossier en polypropylène

		Prezzo unitario € Unit price € Prix Unitaire €							
							mc	kg	
SCHIENALE E SEDILE IN POLIPROPILENE WHITE OR BLACK POLYPROPYLENE BACKREST AND SEAT DOSSIER ET ASSISE POLYPROPYLENE									
SNPPNOCR01	Plastiche nere Black plastics Plastique noir		118						
SNPPBOCR01	Plastiche bianche White plastics Plastique blanc		124						
SCHIENALE E SEDILE IMBOTTITI E RIVESTITI PADDED AND UPHOLSTERED BACK AND SEAT DOSSIER ET ASSISE TAPISES									
SNINPCR01	Plastiche nere Black plastics Plastique noir		171	173	190	199	206	239	284
SNIBPCR01	Plastiche bianche White plastics Plastique blanc		176	179	196	205	213	245	290
SCHIENALE IN POLIPROPILENE E SEDILE RIVESTITO WHITE OR BLACK POLYPROPYLENE BACKREST AND SEAT UPHOLSTERED DOSSIER POLYPROPYLENE ET ASSISE TAPISSE									
SNPNPCR01	Plastiche nere Black plastics Plastique noir		157	158	168	174	178	193	219
SNPBPCR01	Plastiche bianche White plastics Plastique blanc		163	164	174	180	184	199	225

A RICHIESTA PLASTICHE IGNIFUGHE CLASSE 1 NEI COLORI: NERO + 25% DA LISTINO

FIRE RETARDANT PLASTICS AVAILABLE IN BLACK COLOR: +25% TO PRICELIST
SUR DEMANDE PLASTIQUES IGNIFUGES DANS LE COLORIS NOIR: +25% SUR TARIF

Consumi schienale rivestito tessuto / Consumption padded backrest fabric / Tissu nécessaire dossier revetu **ml 0,80**

Consumi schienale rivestito pelle / Consumption padded backrest leather / Cuir nécessaire dossier revetue **mq 1,10**

Consumi schienale polipropilene tessuto / Consumption polypropylene backrest fabric / Tissu nécessaire dossier en polypropylène **ml 0,60**

Consumi schienale polipropilene pelle / Consumption polypropylene backrest leather / Cuir nécessaire dossier polypropylène **mq 0,90**



Omologazione ministeriale al fuoco in classe 1IM con rivestimento PLANET o BINGO ELAST / MIRAGE e poliuretano ignifugo (+6% da listino)







Fireproof Italian Ministry homologation in 1IM class with upholstery PLANET or BINGO ELAST / MIRAGE and fire retardant polyurethane (+6% to price list)
Certification Italienne contre le feu en classe 1IM avec revêtement PLANET ou BINGO ELAST/MIRAGE et polyuréthane ignifuge (+6% sur le tarif)

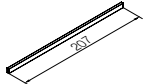
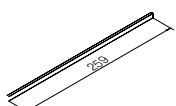

Ignifugo + extra 6% da listino prezzi

Fireproof + extra 6% to price list
Non feu + extra 6% sur le tarif

Sunny new panca

Accessori / Accessories / Accessoires			Prezzo unitario € Unit price € Prix Unitaire €
BONPT2	Elemento trave 2 p. Two-seater beam Poutre 2 places		37
BONPT3	Elemento trave 3 p. Three-seater beam Poutre 3 places		48
BONPT4	Elemento trave 4 p. Four-seater beam Poutre 4 places		60
BONPT5	Elemento trave 5 p. Five-seater beam Poutre 5 places		71
BONPGSNR	Elemento term. nero - Gamba (1 pz) Black leg (1 pc) Pied noir pour poutre (1pc)		55
BONPGSCR	Elemento term. cromato - Gamba (1 pz) Chromed leg (1 pc) Pied chromé pour poutre (1pc)		61
BONPPA	Piano appoggio nero Black table for bench Table noir pour poutre		66

“Il desiderio di leggerezza e comfort all’interno di spazi sempre più complessi è dovuto dal momento in cui viviamo, in continua e crescente accelerazione.

La qualità dello spazio in cui ci troviamo influisce su ogni cosa, ci teniamo che al loro interno, materiali e forme unendosi ci facciano stare bene e offrano autenticità, affetto e ispirazione.”

Visitatore

Visitor chairs / Chaises visiteur

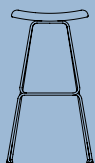

CHAT
70



CLEA
71



CLEA
PLUS
72



CLOP
73



EON
82



LOFT
89

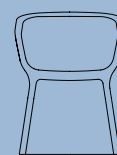

MARGARITA
91

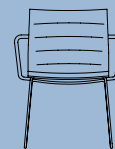

MISS
92

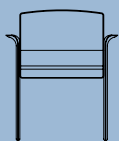

MISTER
97

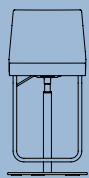

PRINCE
98

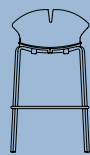

REDHOT
99

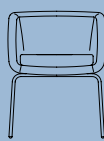



VANITY
100

“The desire for lightness and comfort within ever more complex spaces results from to the moment we are currently living, in continuous and increasing acceleration. The quality of the spaces in which we find ourselves affects everything, we take care that, within them, uniting materials and shapes make us feel good and offer authenticity, affection and inspiration.”

Chat

- **Imbottitura in poliuretano espanso**
Polyurethane foam padding
Rembourrage en mousse de polyuréthane
- **Struttura scocca in legno**
Shell in wood
Structure assise en bois

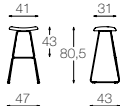
	Cat. F	Cat. G	Cat. S	Cat. TOP	Cat. EXTRA	Pelle Leather Cuir FIESTA	Pelle Leather Cuir NUVOLA	 mc	 kg
SGABELLO FISSO FIXED STOOL TABOURET FIXE CHISL									
Telaio nero (NR) o bianco (BC) Black Frame (NR) or white (BC) Pièment noir (NR) ou blanc (BC)	160	162	168	173	178	189	200	0.27	8.45
									

Consumi tessuto / Consumption fabric / Tissu nécessaire **ml 0,30**
Consumi pelle / Consumption leather / Cuir nécessaire **mq 0,50**



Omologazione ministeriale al fuoco in classe 1IM con rivestimento PLANET o BINGO ELAST / MIRAGE e poliuretano ignifugo (+6% da listino) IN CORSO
 Fireproof Italian Ministry homologation in 1IM class with upholstery PLANET or BINGO ELAST / MIRAGE and fire retardant polyurethane (+6% to price list) ONGOING
 Certification Italienne contre le feu en classe 1IM avec revêtement PLANET ou BINGO ELAST/MIRAGE et polyuréthane ignifuge (+6% sur le tarif) EN COURS



Ignifugo + extra 6% da listino prezzi
 Fireproof + extra 6% to price list
 Non feu + extra 6% sur le tarif

- **Imbottitura in schiumato a freddo**
Injected foam padding
Rembourrage en mousse moulée à froid
- **Struttura scocca in acciaio**
Shell in steel
Structure en acier

		Cat. F	Cat. G	Cat. S	Cat. TOP	Cat. EXTRA	Pelle Leather Cuir FIESTA	Pelle Leather Cuir NUVOLA	mc	kg
POLTRONCINA ARMCHAIR PETITE CHAISE										
CLSLCR01	Telaio slitta cromato Chromed cantilever frame Piètement luge chromé		405	413	452	459	488	561	616	0.33 12.45
CLSLBRCR11	Telaio slitta con braccioli cromato Sled chromed frame with arms Piètement luge avec accoudoirs chromé		497	505	544	551	579	653	708	0.33 12.65
CLTLAL01	4 lame girevole in alluminio, meccanismo di ritorno 4 blades alu frame, swivel Return mechanism Piètement pivotant 4 branches aluminium, mécanisme retour		506	514	555	561	591	667	723	0.21 12
CLTGCR01	Telaio cromato tubolare girevole Tubular chromed frame, swivel Piètement tubulaire chromé		533	541	581	587	616	689	745	0.27 14.25
CLR_01P	Telaio alluminio 4 razze piramidale nero (NR) o bianco (BC) su piedini Pyramidal 4 star aluminium frame black (NR) or white (BC) on glides Piètement en aluminium 4 branches pyramidale noir(NR) ou blanc(BC) sur patins		490	498	538	544	573	646	701	0.24 11.05
CLRAL01P	Telaio alluminio 4 razze piramidale alluminio lucido su piedini Pyramidal 4 star polished aluminium frame on glides Piètement en aluminium poli 4 branches pyramidale sur patins		510	517	557	564	592	666	720	0.24 11.05
CLR_01R	Telaio alluminio 4 razze piramidale nero (NR) o bianco (BC) su ruote Pyramidal 4 star aluminium frame black (NR) or white (BC) on castors Piètement en aluminium 4 branches pyramidale noir(NR) ou blanc(BC) sur roulettes		490	498	538	544	573	646	701	0.24 11.45
CLRAL01R	Telaio alluminio 4 razze piramidale alluminio lucido su ruote Pyramidal 4 star polished aluminium frame on castors Piètement en aluminium poli 4 branches pyramidale sur roulettes		510	517	557	564	592	666	720	0.24 11.45
CLGPAL01	Base alluminio 5 razze, ruote, elevazione a gas Aluminium 5 star base on castors, gaslift Piètement 5 branches aluminium, roulettes, elevation gaz		434	443	482	489	518	591	646	0.24 12.75

Consumi tessuto / Consumption fabric / Tissu nécessaire **ml 1,40**

Consumi pelle / Consumption leather / Cuir nécessaire **mq 2,30**



Omologazione ministeriale al fuoco in classe 1IM con rivestimento PLANET o BINGO ELAST / MIRAGE e poliuretano ignifugo (+6% da listino)

Fireproof Italian Ministry homologation in 1IM class with upholstery PLANET or BINGO ELAST / MIRAGE and fire retardant polyurethane (+6% to price list)

Certification Italienne contre le feu en classe 1IM avec revêtement PLANET ou BINGO ELAST/MIRAGE et polyuréthane ignifuge (+6% sur le tarif)

Clea plus

- **Imbottitura in schiumato a freddo**
Injected foam padding
Rembourrage en mousse moulée à froid
- **Struttura scocca in acciaio**
Shell in steel
Structure en acier

		Cat. F	Cat. G	Cat. S	Cat. TOP	Cat. EXTRA	Pelle Leather Cuir FIESTA	Pelle Leather Cuir NUVOLA	mc	kg
POLTRONCINA CON BRACCIOLI IMBOTTITI ARMCHAIR WITH PADDED ARMS PETITE CHAISE AVEC ACCOUDOIRS REMBOURRES										
CLSLCR11	Telaio slitta cromato Fixed sled chromed frame Piètement luge chromé		472	482	533	541	577	662	730	0.33 13.35
CLTLAL11	4 lame girevole in alluminio, meccanismo di ritorno 4 blades aluminium frame, swivel, return mechanism Piètement pivotant 4 branches aluminium, mécanisme retour		604	616	671	679	719	810	883	0.21 12.9
CLTGCR11	Telaio tubolare girevole Tubular frame, swivel Piètement tubulaire chromé		605	616	666	675	712	796	863	0.27 15.15
CL4WN11	Telaio 4 gambe in frassino naturale, girevole 4 legs ash wood frame, swivel Piètement 4 pieds en bois de frêne		740	751	805	815	880	945	1.015	0.32 12
CLR_11P	Telaio alluminio 4 razze piramidale nero (NR) o bianco (BC) su piedini Pyramidal 4 star aluminium frame black (NR) or white (BC) on glides Piètement en aluminium 4 branches pyramidale noir(NR) ou blanc(BC) sur patins		563	573	624	632	670	753	821	0.24 11.95
CLRAL11P	Telaio alluminio 4 razze piramidale alluminio lucido su piedini Pyramidal 4 star polished aluminium frame on glides Piètement en aluminium poli 4 branches pyramidale sur patins		582	592	644	651	689	772	840	0.24 11.95
CLR_11R	Telaio alluminio 4 razze piramidale nero (NR) o bianco (BC) su ruote Pyramidal 4 star aluminium frame black (NR) or white (BC) on castors Piètement en aluminium 4 branches pyramidale noir(NR) ou blanc(BC) sur roulettes		563	573	624	632	670	753	821	0.24 12.35
CLRAL11R	Telaio alluminio 4 razze piramidale alluminio lucido su ruote Pyramidal 4 star polished aluminium frame on castors Piètement en aluminium poli 4 branches pyramidale sur roulettes		582	592	644	651	689	772	840	0.24 12.35
CLGPAL11	Base alluminio 5 razze, ruote, elevazione a gas Aluminium 5 star base on castors, gaslift Piètement 5 branches aluminium, roulettes, elevation gaz		504	515	565	573	611	695	762	0.24 13.65

Consumi tessuto / Consumption fabric / Tissu nécessaire **ml 1,80**
Consumi pelle / Consumption leather / Cuir nécessaire **m² 2,80**





Omologazione ministeriale al fuoco in classe 11M con rivestimento PLANET o BINGO ELAST / MIRAGE e poliuretano ignifugo (+6% da listino)
Fireproof Italian Ministry homologation in 11M class with upholstery PLANET or BINGO ELAST / MIRAGE and fire retardant polyurethane (+6% to price list)
Certification Italienne contre le feu en classe 11M avec revêtement PLANET ou BINGO ELAST/MIRAGE et polyuréthane ignifuge (+6% sur le tarif)

Clop

EN-16139	EN-1728	EN-1022	CAM
----------	---------	---------	-----

■ **Scocca in polipropilene colorato**
Shell in polypropylene
Coque en polypropylène

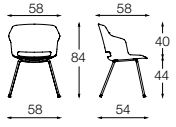
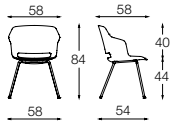
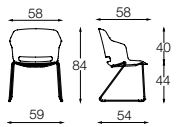
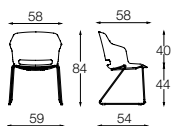
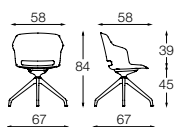
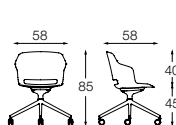
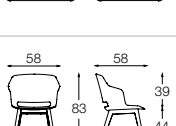
		Prezzo unitario € Unit price € Prix Unitaire €		 mc	 kg	
POLTRONCINA ARMCHAIR PETITE CHAISE						
CPQ _ _ _ _	TELAIO 4 GAMBE verniciato, BIANCO (BC) o NERO (NR) 4 LEGS FRAME lacquered, WHITE (BC) or BLACK (NR) 4 PIEDS laqués BLANC (BC) ou NOIR (NR)		150	0.21	7.3	
CPQCR _ _	TELAIO 4 GAMBE cromato 4 LEGS FRAME chromed 4 PIEDS chromés		162	0.21	7.3	
CPC _ _ _ _	TELAIO SLITTA verniciato, BIANCO (BC) o NERO (NR) SLED FRAME lacquered, WHITE (BC) or BLACK (NR) TRAÎNEAU laqué BLANC (BC) ou NOIR (NR)		173	0.21	9.4	max 6 pz 6pcs 6 pc
CPCCR _ _	TELAIO SLITTA cromato SLED FRAME chromed TRAÎNEAU chromé		185	0.21	9.4	max 6 pz 6pcs 6 pc
CPTG _ _ _ _	TELAIO GIREVOLE 4 RAZZE polipropilene BIANCO (BC) o NERO (NR) SWIVEL FRAME, 4 star in polypropylene BLACK (NR) or WHITE (BC) on glides STRUCTURE PIVOTANT 4 BRANCHES en polypropylène BLANC (BC) ou NOIR (NR) sur patins		173	0.21	7.7	
CPRG _ _ _ _	TELAIO GIREVOLE 4 RAZZE alluminio lucido (AL), NERO (NR) o BIANCO (BC) su ruote SWIVEL FRAME, 4 star n polished aluminium (AL), BLACK (NR) or WHITE (BC) on castors STRUCTURE PIVOTANT 4 BRANCHES sur roulettes en ALUMINIUM (AL), NOIR (NR) ou BLANC (BC)		219	0.21	8.6	
CPQWNT _ _	TELAIO 4 GAMBE in frassino naturale 4 LEGS FRAME in ash wood 4 PIEDS en frêne naturel		289	0.24	9.75	

PER COMPLETARE IL CODICE DELLA SEDIA: LE PRIME DUE LETTERE DA RIEMPIRE FANNO RIFERIMENTO AL COLORE TELAIO, LE ULTIME DUE AL COLORE SCOCCA
TO FILL THE CHAIR CODE: THE FIRST TWO BLANK LETTERS ARE REFERRING TO THE COLOR OF THE BASE, WHILE THE LATEST TWO TO THE SHELL COLOR
POUR COMPLETER LE CODE DE LA CHAISE: LES PREMIERES 2 LETTRES REFERENT AU COLORIS DE LA STRUCTURE, LES DERNIERES 2 AU COLORIS DE LA COQUE



COLORI SCOCCA DISPONIBILI: BIANCO (BC) SIMIL RAL 9010, NERO (NR) SIMIL RAL 9011, ARANCIONE CORALLO (RO) PANTONE 7417U, VERDE FELCE (VE) PANTONE 553U, AZZURRO (AZ) NCS S 3010-B10G, BEIGE (BE) NCS S 3005-Y80R, ROSSO SCURO (RS) NCS S 3560-Y90R.

SHELL AVAILABLE COLORS: WHITE (BC) SIMIL RAL9010, BLACK (NR) SIMIL RAL 9011, ORANGE (RO) PANTONE 7417U, GREEN (VE) PANTONE 553U, LIGHT BLUE (AZ) NCS S 3010-B10G, BEIGE (BE) NCS S 3005-Y80R, DARK RED (RS) NCS S 3560-Y90R
CHOIX DE COLORIS DE LA COQUE: BLANC(BC) SIMIL RAL 9010, NOIR (NR) SIMIL RAL 9011, ROUGE CORAIL (RO) PANTONE 7417U, VERT (VE) PANTONE 553U, BLEU CLAIR (AZ) NCS S 3010-B10G, BEIGE (BE) NCS S 3005-Y80R, ROUGE FONCE' (RS) NCS S 3560-Y90R

Clop

■ **Scocca in polipropilene colorato**
Shell in polypropylene
Coque en polypropylène

EN-1335	EN-1728	EN-1022	CAM
---------	---------	---------	-----

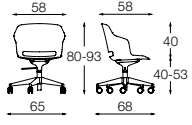
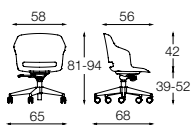
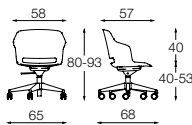
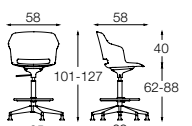
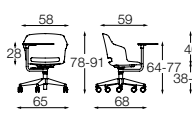
		Prezzo unitario € Unit price € Prix Unitaire €	 mc	 kg	
POLTRONCINA ARMCHAIR PETITE CHAISE					
CPGG _ _ _ _	<p>REGOLAZIONE GAS, base 5 razze polipropilene BIANCO (BC) o NERO (NR)</p> <p>GASLIFT ADJUSTMENT, 5 star polypropylene WHITE (BC) or BLACK (NR)</p> <p>REGULATION GAS, piètement 5 rayons en polypropylène BLANC (BC) ou NOIR (NR)</p> 	162	0.21	9.2	
CPKT _ _ _ _	<p>REGOLAZIONE GAS KT base 5 razze polipropilene BIANCO (BC) o NERO (NR)</p> <p>GASLIFT ADJUSTMENT KNEE-TILT MECHANISM, 5 star polypropylene WHITE (BC) or BLACK (NR)</p> <p>REGULATION GAZ ET KT, piètement 5 rayons en polypropylène BLANC (BC) ou NOIR (NR)</p> 	219	0.21	10.4	
CPOS _ _ _ _	<p>REGOLAZIONE GAS OSCILLANTE base 5 razze polipropilene BIANCO (BC) o NERO (NR)</p> <p>GASLIFT ADJUSTMENT BALANCE MECHANISM, 5 star polypropylene WHITE (BC) or BLACK (NR)</p> <p>REGULATION GAZ ET OSCILLANT, piètement 5 rayons en polypropylène BLANC (BC) ou NOIR (NR)</p> 	219	0.21	10.4	
CPSP _ _ _ _	<p>SGABELLO OPERATIVO, GAS PIASTRA, base 5 razze polipropilene BIANCO (BC) o NERO (NR)</p> <p>TASK STOOL, GASLIFT, 5 star polypropylene WHITE (BC) or BLACK (NR)</p> <p>TABOURET OPERATIF, piètement 5 rayons en polypropylène BLANC (BC) ou NOIR (NR)</p> 	243	0.21	10.7	
CPGP _ _ _ _ TB	<p>REGOLAZIONE GAS, su base 5 razze polipropilene BIANCO (BC) o NERO (NR) con supporto in metallo BIANCO e tavoletta girevole 360° HPL BIANCA</p> <p>GASLIFT ADJUSTMENT, 5 star polypropylene WHITE (BC) or BLACK (NR) with white support and white HPL table 360° swivel</p> <p>REGULATION GAZ, piètement 5 rayons en polypropylène BLANC (BC) ou NOIR (NR) avec tablette en HPL BLANC pivotant 360° et support blanc</p> 	393	0.24	14.15	

PER COMPLETARE IL CODICE DELLA SEDIA: LE PRIME DUE LETTERE DA RIEMPIRE FANNO RIFERIMENTO AL COLORE TELAIO, LE ULTIME DUE AL COLORE SCOCCA
TO FILL THE CHAIR CODE: THE FIRST TWO BLANK LETTERS ARE REFERRING TO THE COLOR OF THE BASE, WHILE THE LATEST TWO TO THE SHELL COLOR
POUR COMPLETER LE CODE DE LA CHAISE: LES PREMIERES 2 LETTRES REFERENT AU COLORES DE LA STRUCTURE, LES DERNIERES 2 AU COLORES DE LA COQUE





COLORI SCOCCA DISPONIBILI: BIANCO (BC) SIMIL RAL 9010, NERO (NR) SIMIL RAL 9011, ARANCIONE CORALLO (RO) PANTONE 7417U, VERDE FELCE (VE) PANTONE 553U, AZZURRO (AZ) NCS S 3010-B10G, BEIGE (BE) NCS S 3005-Y80R, ROSSO SCURO (RS) NCS S 3560-Y90R.



SHELL AVAILABLE COLORS: WHITE (BC) SIMIL RAL9010, BLACK (NR) SIMIL RAL 9011, ORANGE (RO) PANTONE 7417U, GREEN (VE) PANTONE 553U, LIGHT BLUE (AZ) NCS S 3010-B10G, BEIGE (BE) NCS S 3005-Y80R, DARK RED (RS) NCS S 3560-Y90R
CHOIX DE COLORES DE LA COQUE: BLANC(BC) SIMIL RAL 9010, NOIR (NR) SIMIL RAL 9011, ROUGE CORAIL (RO) PANTONE 7417U, VERT (VE) PANTONE 553U, BLEU CLAIR (AZ) NCS S 3010-B10G, BEIGE (BE) NCS S 3005-Y80R, ROUGE FONCE (RS) NCS S 3560-Y90R

Clop

■ **Scocca in polipropilene colorato**
Shell in polypropylene
Coque en polypropylène

EN-1335	EN-1728	EN-1022	CAM
---------	---------	---------	-----

Accessori / Accessories / Accessoires		Prezzo unitario € Unit price € Prix Unitaire €	
AL	Base 5 razze alluminio su ruote 5-star polished aluminium base on castors Piédiment 5 rayons en aluminium sur roulettes 		49
RF	Ruote forate grigie/nere Castors with holes grey/black Roulettes avec trous gris/noir 		35
RF__	Ruote forate bianche (BC) o nere (NR) - design Philippe Starck White (BC) or BLACK (NR) castors with holes - design Philippe Starck Roulettes avec trous blancs (BC) ou noir (NR) - design Philippe Starck 		40
CPTVFNRR	Tavoletta scrittoio in nylon nero Black writing tablet in nylon Tablette ecriteiro en nylon noir 		64

Accessori / Accessories / Accessoires	Cat. F	Cat. G	Cat. S	Cat. TOP	Cat. EXTRA	Pelle Leather Cuir FIESTA	Pelle Leather Cuir NUVOLA
CPSDRIV Sedile imbottito e rivestito Seat padded and upholstered Assise rembourré et revêtu 	66	69	81	82	91	116	133
CPSHRIV Schienale rivestito Upholstered back Dossier revêtu 	98	104	121	127	139	162	185
CPSRIV Schienale rivestito con supporto lombare regolabile Upholstered back with lumbar support adj in height Dossier revêtu avec soutien lombaire réglable en hauteur 	121	127	156	162	179	202	231

PER COMPLETARE IL CODICE DELLA SEDIA: LE PRIME DUE LETTERE DA RIEMPIRE FANNO RIFERIMENTO AL COLORE TELAIO, LE ULTIME DUE AL COLORE SCOCCA
TO FILL THE CHAIR CODE: THE FIRST TWO BLANK LETTERS ARE REFERRING TO THE COLOR OF THE BASE, WHILE THE LATEST TWO TO THE SHELL COLOR
POUR COMPLETER LE CODE DE LA CHAISE: LES PREMIERES 2 LETTRES REFERENT AU COLORIS DE LA STRUCTURE, LES DERNIERES 2 AU COLORIS DE LA COQUE

COLORI SCOCCA DISPONIBILI: BIANCO (BC) SIMIL RAL 9010, NERO (NR) SIMIL RAL 9011, ARANCIONE CORALLO (RO) PANTONE 7417U, VERDE FELCE (VE) PANTONE 553U, AZZURRO (AZ) NCS S 3010-B10G, BEIGE (BE) NCS S 3005-Y80R, ROSSO SCURO (RS) NCS S 3560-Y90R.

SHELL AVAILABLE COLORS: WHITE (BC) SIMIL RAL9010, BLACK (NR) SIMIL RAL 9011, ORANGE (RO) PANTONE 7417U, GREEN (VE) PANTONE 553U, LIGHT BLUE (AZ) NCS S 3010-B10G, BEIGE (BE) NCS S 3005-Y80R, DARK RED (RS) NCS S 3560-Y90R

CHOIX DE COLORIS DE LA COQUE: BLANC(BC) SIMIL RAL 9010, NOIR (NR) SIMIL RAL 9011, ROUGE CORAIL (RO) PANTONE 7417U, VERT (VE) PANTONE 553U, BLEU CLAIR (AZ) NCS S 3010-B10G, BEIGE (BE) NCS S 3005-Y80R, ROUGE FONCE (RS) NCS S 3560-Y90R

Consumi SOLO SEDILE Tessuto / Consumption ONLY SEAT fabric / Tissu nécessaire SEULEMENT ASSISE **ml 0,50**

Consumi SOLO SEDILE Pelle / Consumption ONLY SEAT leather / Cuir nécessaire SEULEMENT ASSISE **mq 0,80**

Consumi SOLO SCHIENALE Tessuto / Consumption ONLY BACK fabric / Tissu nécessaire SEULEMENT DOSSIER **ml 1,00**

Consumi SOLO SCHIENALE Pelle / Consumption ONLY BACK leather / Cuir nécessaire SEULEMENT DOSSIER **mq 1,40**



Omologazione ministeriale al fuoco in classe 1IM con rivestimento PLANET o BINGO ELAST / MIRAGE e poliuretano ignifugo (+6% da listino)

Fireproof Italian Ministry homologation in 1IM class with upholstery PLANET or BINGO ELAST / MIRAGE and fire retardant polyurethane (+6% to price list)









Certification ministérielle contre le feu en classe 1IM avec revêtement PLANET ou BINGO ELAST / MIRAGE et polyuréthane ignifuge (+ 6% à partir de la liste de prix)



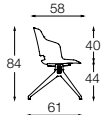

Ignifugo + extra 6% da listino prezzi

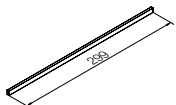
Fireproof + extra 6% to price list

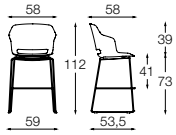
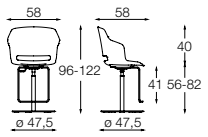
Non feu + extra 6% sur le tarif

			Prezzo unitario € Unit price € Prix Unitaire €	 mc	 kg
PANCA IN POLIPROPILENE BENCH IN POLYPROPYLENE BANC EN POLYPROPYLENE					
CPP_	Seduta per panca Bench shell Coque pour poutre		116		
BONPT2	Trave 2 posti 2 seater beam Poutre 2 places		37		
BONPT3	Trave 3 posti 3 seater beam Poutre 3 places		48		
CPPT4	Trave 4 posti 4 seater beam Poutre 4 places		61		
CPPT5	Trave 5 posti (Obbligatorio utilizzare 3 gambe) 5-seater beam (Imperative use 3 legs) Poutre 5 places (obligatoire mettre 3 pieds)		72		
CPPGAL	ELEMENTO TERMINALE alluminio (1 GAMBA) Aluminium leg Pied en aluminium (1 pièce)		100		
BONPPA	Piano appoggio nero Black table for bench Table noir pour poutre		66		
SGABELLO STOOL TABOURET					
CPZCCR _ _	Sgabello slitta cromato, fisso Stool, fixed chromed sled frame Tabouret fixe chromé		196	0.27	9.05
CPZGCR _ _	Sgabello girevole su gas, base rotonda cromata Stool, swivel chromed base, gaslift Tabouret pivotant, avec gaz et base chromé		404	0.38	19.55

Accessori / Accessories / Accessoires			Cat. F	Cat. G	Cat. S	Cat. TOP	Cat. EXTRA	Pelle Leather Cuir FIESTA	Pelle Leather Cuir NUVOLA
CPSDRIV	Sedile imbottito e rivestito Seat padded and upholstered Assise rembourré et revêtu		66	69	81	82	91	116	133
CPSHRIV	Schienale rivestito Upholstered back Dossier revêtu		98	104	121	127	139	162	185
CPSSRIV	Schienale rivestito con supporto lombare regolabile Upholstered back with lumbar support adj in height Dossier revêtu avec soutien lombaire réglable en hauteur		121	127	156	162	179	202	231

PER COMPLETARE IL CODICE DELLA SEDIA: LE PRIME DUE LETTERE DA RIEMPIRE FANNO RIFERIMENTO AL COLORE TELAIO, LE ULTIME DUE AL COLORE SCOCCA
TO FILL THE CHAIR CODE: THE FIRST TWO BLANK LETTERS ARE REFERRING TO THE COLOR OF THE BASE, WHILE THE LATEST TWO TO THE SHELL COLOR
POUR COMPLETER LE CODE DE LA CHAISE: LES PREMIERES 2 LETTRES REFERENT AU COLORIS DE LA STRUCTURE, LES DERNIERES 2 AU COLORIS DE LA COQUE

COLORI SCOCCA DISPONIBILI: BIANCO (BC) SIMIL RAL 9010, NERO (NR) SIMIL RAL 9011, ARANCIONE CORALLO (RO) PANTONE 7417U, VERDE FELCE (VE) PANTONE 553U, AZZURRO (AZ) NCS S 3010-B10G, BEIGE (BE) NCS S 3005-Y80R, ROSSO SCURO (RS) NCS S 3560-Y90R.

SHELL AVAILABLE COLORS: WHITE (BC) SIMIL RAL9010, BLACK (NR) SIMIL RAL 9011, ORANGE (RO) PANTONE 7417U, GREEN (VE) PANTONE 553U, LIGHT BLUE (AZ) NCS S 3010-B10G, BEIGE (BE) NCS S 3005-Y80R, DARK RED (RS) NCS S 3560-Y90R

CHOIX DE COLORIS DE LA COQUE: BLANC(BC) SIMIL RAL 9010, NOIR (NR) SIMIL RAL 9011, ROUGE CORAIL (RO) PANTONE 7417U, VERT (VE) PANTONE 553U, BLEU CLAIR (AZ) NCS S 3010-B10G, BEIGE (BE) NCS S 3005-Y80R, ROUGE FONCE (RS) NCS S 3560-Y90R

Consumi SOLO SEDILE Tessuto / Consumption ONLY SEAT fabric / Tissu nécessaire SEULEMENT ASSISE **ml 0,50**

Consumi SOLO SEDILE Pelle / Consumption ONLY SEAT leather / Cuir nécessaire SEULEMENT ASSISE **mq 0,80**

Consumi SOLO SCHIENALE Tessuto / Consumption ONLY BACK fabric / Tissu nécessaire SEULEMENT DOSSIER **ml 1,00**

Consumi SOLO SCHIENALE Pelle / Consumption ONLY BACK leather / Cuir nécessaire SEULEMENT DOSSIER **mq 1,40**





Ignifugo + extra 6% da listino prezzi

Fireproof + extra 6% to price list

Non feu + extra 6% sur le tarif

Clop riv

- **Imbottitura in poliuretano espanso**
Polyurethane foam padding
Rembourrage en mousse de polyuréthane
- **Interni in polipropilene**
Inner in polypropylene
Structure intérieur en polypropylène

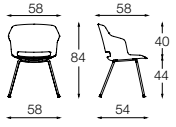
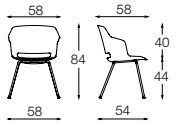
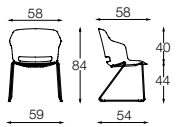
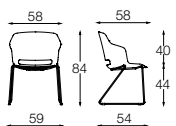
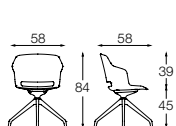
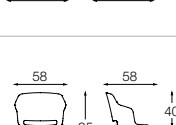
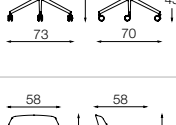
						Pelle Leather Cuir FIESTA	Pelle Leather Cuir NUVOLA	Pelle Hide Sellier CUOIO	 mc	 kg	
POLTRONCINA RIVESTITA ARMCHAIR FULLY UPHOLSTERED PETITE CHAISE ENTIEREMENT RECOUVERTE											
CPQ_RV	TELAIO 4 GAMBE verniciato, BIANCO (BC), NERO (NR) 4 LEGS FRAME lacquered, WHITE (BC), BLACK (NR) 4 PIEDS laqués BLANC (BC) ou NOIR (NR)		374	386	431	442	476	544	601	714	0.21 7.3
CPQCRRV	TELAIO 4 GAMBE cromato 4 LEGS FRAME chromed 4 PIEDS chromés		386	397	442	454	488	556	612	726	0.21 7.3
CPC_RV	TELAIO SLITTA verniciato, BIANCO (BC), NERO (NR) SLED FRAME lacquered, WHITE (BC), BLACK (NR) TRÂINEAU laqué BLANC (BC) ou NOIR (NR)		408	420	465	476	510	578	635	737	0.21 9.4 max 4 pz 4 pcs 4 pc
CPCCRRV	TELAIO SLITTA cromato SLED FRAME chromed TRÂINEAU chromé		420	431	476	488	522	590	646	748	0.21 9.4 max 4 pz 4 pcs 4 pc
CPTG_RV	TELAIO GIREVOLE 4 RAZZE polipropilene, BIANCO (BC) o NERO (NR) SWIVEL FRAME, 4 star in polypropylene BLACK (NR) or WHITE (BC) on glides STRUCTURE PIVOTANT 4 BRANCHES en polypropylène BLANC (BC) ou NOIR (NR) sur patins		397	408	454	465	499	567	624	737	0.21 7.7
CPRG_RV	TELAIO GIREVOLE 4 RAZZE alluminio lucido (AL), NERO (NR) o BIANCO (BC) su ruote SWIVEL FRAME, 4 star in polished aluminium (AL), BLACK (NR) or WHITE (BC) on castors STRUCTURE PIVOTANT 4 BRANCHES sur roulettes en ALUMINIUM (AL), NOIR (NR) ou BLANC (BC)		431	442	488	499	533	601	658	771	0.21 8.6
CPQWTRV	TELAIO 4 GAMBE in frassino naturale 4 LEGS FRAME in ash wood 4 PIEDS en frêne naturel		510	522	567	578	612	680	737	851	0.24 9.75

CUOIO DISPONIBILE IN 2 COLORI (NERO E NATURALE)
SADDLE LEATHER AVAILABLE IN 2 COLORS (NATURAL AND BLACK)
CUIR SELLIER DISPONIBLE EN 2 COLORES (NATUREL OU NOIR)

Consumi tessuto / Fabric consumption / Tissu nécessaire ml 1,60
Consumi pelle / Consumption leather / Cuir nécessaire mq 2,30



Omologazione ministeriale al fuoco in classe 1IM con rivestimento PLANET o BINGO ELAST / MIRAGE e poliuretano ignifugo (+6% da listino)

Fireproof Italian Ministry homologation in 1IM class with upholstery PLANET or BINGO ELAST / MIRAGE and fire retardant polyurethane (+6% to price list)

Certification ministérielle contre le feu en classe 1IM avec revêtement PLANET ou BINGO ELAST / MIRAGE et polyuréthane ignifuge (+ 6% à partir de la liste de prix)



Ignifugo + extra 6% da listino prezzi



Fireproof + extra 6% to price list

Non feu + extra 6% sur le tarif

Clop riv

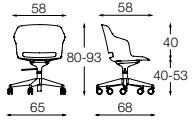
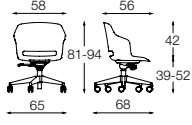
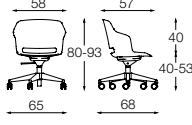
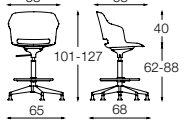
- **Imbottitura in poliuretano espanso**
Polyurethane foam padding
Rembourrage en mousse de polyuréthane
- **Interni in polipropilene**
Inner in polypropylene
Structure intérieur en polypropylène

	Cat. F	Cat. G	Cat. S	Cat. TOP	Cat. EXTRA	Pelle Leather Cuir FIESTA	Pelle Leather Cuir NUVOLA	Pelle Hide Sellier CUOIO	mc	kg	
POLTRONCINA RIVESTITA ARMCHAIR FULLY UPHOLSTERED PETITE CHAISE ENTIEREMENT RECOUVERTE											
CPGG__RV											
REGOLAZIONE GAS, base 5 razze polipropilene BIANCO (BC) o NERO (NR) GASLIFT ADJUSTMENT, 5 star polypropylene WHITE (BC) or BLACK (NR) REGULATION GAS, piètement 5 rayons en polypropylène BLANC (BC) ou NOIR (NR)											
	386	397	442	454	488	556	612	726	0.21	9.2	
CPKT__RV											
REGOLAZIONE GAS KT base 5 razze polipropilene BIANCO (BC) o NERO (NR) GASLIFT ADJUSTMENT KNEE-TILT MECHANISM, 5 star polypropylene WHITE (BC) or BLACK (NR) REGULATION GAZ ET KT, piètement 5 rayons en polypropylène BLANC (BC) ou NOIR (NR)											
	431	442	488	499	533	601	658	771	0.21	10.4	
CPOS__RV											
REGOLAZIONE GAS OSCILLANTE base 5 razze polipropilene BIANCO (BC) o NERO (NR) GASLIFT ADJUSTMENT BALANCE MECHANISM, 5 star polypropylene WHITE (BC) or BLACK (NR) REGULATION GAZ ET OSCILLANT, piètement 5 rayons en polypropylène BLANC (BC) ou NOIR (NR)											
	431	442	488	499	533	601	658	771	0.21	10.4	
CPSP__RV											
SGABELLO OPERATIVO, GAS PIASTRA, base 5 razze polipropilene BIANCO (BC) o NERO (NR) TASK STOOL, GASLIFT, 5 star polypropylene WHITE (BC) or BLACK (NR) TABOURET OPERATIF, piètement 5 rayons en polypropylène BLANC (BC) ou NOIR (NR)											
	442	454	499	510	544	612	669		0.21	10.7	

Accessori / Accessories / Accessoires		Prezzo unitario € Unit price € Prix Unitaire €
AL	Base 5 razze alluminio su ruote 5-star polished aluminium base on castors Pièment 5 rayons en aluminium sur roulettes	 49
RF	Ruote forate grigie/nere Castors with holes grey/black Roulettes avec trous gris/noir	 35
RF__	Ruote forate bianche (BC) o nere (NR) - design Philippe Starck White (BC) or BLACK (NR) castors with holes - design Philippe Starck Roulettes avec trous blancs (BC) ou noir (NR) - design Philippe Starck	 40

CUOIO DISPONIBILE IN 2 COLORI (NERO E NATURALE)

SADDLE LEATHER AVAILABLE IN 2 COLORS (NATURAL AND BLACK)
CUIR SELLIER DISPONIBLE EN 2 COLORIS (NATUREL OU NOIR)

Consumi tessuto / Fabric consumption / Tissu nécessaire **ml 1,60**

Consumi pelle / Consumption leather / Cuir nécessaire **mq 2,30**



Omologazione ministeriale al fuoco in classe 11M con rivestimento PLANET o BINGO ELAST / MIRAGE e poliuretano ignifugo (+6% da listino)

Fireproof Italian Ministry homologation in 11M class with upholstery PLANET or BINGO ELAST / MIRAGE and fire retardant polyurethane (+6% to price list)

Certification ministérielle contre le feu en classe 11M avec revêtement PLANET ou BINGO ELAST / MIRAGE et polyuréthane ignifuge (+ 6% à partir de la liste de prix)



Ignifugo + extra 6% da listino prezzi

Fireproof + extra 6% to price list

Non feu + extra 6% sur le tarif

Clop riv

- **Imbottitura in poliuretano espanso**
Polyurethane foam padding
Rembourrage en mousse de polyuréthane
- **Interni in polipropilene**
Inner in polypropylene
Structure interieur en polypropylène

			Cat. F	Cat. G	Cat. S	Cat. TOP	Cat. EXTRA	Pelle Leather Cuir FIESTA	Pelle Leather Cuir NUVOLA	Pelle Hide Sellier CUOIO	mc	kg	
PANCA RIVESTITA BENCH FULLY UPHOLSTERED BANC COMPLETEMENT RECOUVERTE													
CPPRV	Seduta per panca Bench shell Coque pour poutre		329	340	386	397	431	499	556	669			

Accessori / Accessories / Accessoires			Prezzo unitario € Unit price € Prix Unitaire €	
BONPT2	Trave 2 posti 2 seater beam Poutre 2 places			37
BONPT3	Trave 3 posti 3 seater beam Poutre 3 places			48
CPPT4	Trave 4 posti 4 seater beam Poutre 4 places			61
CPPT5	Trave 5 posti (Obbligatorio utilizzare 3 gambe) 5-seater beam (Imperative use 3 legs) Poutre 5 places (obligatoire mettre 3 pieds)			72
CPPGAL	ELEMENTO TERMINALE alluminio (1 GAMBA) Aluminium leg Pied en aluminium (1 pièce)			100
BONPPA	Piano appoggio nero Black table for bench Table noir pour poutre			66

CUOIO DISPONIBILE IN 2 COLORI (NERO E NATURALE)
SADDLE LEATHER AVAILABLE IN 2 COLORS (NATURAL AND BLACK)
CUIR SELLIER DISPONIBLE EN 2 COLORIS (NATUREL OU NOIR)

Consumi tessuto / Fabric consumption / Tissu nécessaire ml 1,60
Consumi pelle / Consumption leather / Cuir nécessaire mq 2,30



Omologazione ministeriale al fuoco in classe 1IM con rivestimento PLANET o BINGO ELAST / MIRAGE e poliuretano ignifugo (+6% da listino)
Fireproof Italian Ministry homologation in 1IM class with upholstery PLANET or BINGO ELAST / MIRAGE and fire retardant polyurethane (+6% to price list)
Certification ministérielle contre le feu en classe 1IM avec revêtement PLANET ou BINGO ELAST / MIRAGE et polyuréthane ignifuge (+ 6% à partir de la liste de prix)



Ignifugo + extra 6% da listino prezzi
Fireproof + extra 6% to price list
Non feu + extra 6% sur le tarif

- **Imbottitura in poliuretano espanso**
Polyurethane foam padding
Rembourrage en mousse de polyuréthane
- **Interni in polipropilene**
Inner in polypropylene
Structure intérieur en polypropylène

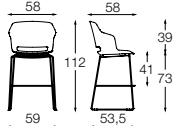
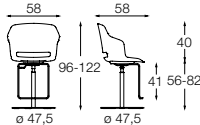
Accessori / Accessories / Accessoires		Cat. F	Cat. G	Cat. S	Cat. TOP	Cat. EXTRA	Pelle Leather Cuir FIESTA	Pelle Leather Cuir NUVOLA	Pelle Hide Sellier CUOIO	
SGABELLO RIVESTITO STOOL FULLY UPHOLSTERED TABOURET ENTIEREMENT RECOUVERT										
CPZCCRRV	Sgabello slitta cromato, fisso Stool, fixed chromed sled frame Tabouret fixe chromé		397	408	454	465	499	567	624	737
CPZGCRRV	Sgabello girevole su gas, base rotonda cromata Stool, swivel chromed base, gaslift Tabouret pivotant, avec gaz et base chromé		584	595	641	652	686	754	811	930

CUOIO DISPONIBILE IN 2 COLORI (NERO E NATURALE)

SADDLE LEATHER AVAILABLE IN 2 COLORS (NATURAL AND BLACK)
CUIR SELLIER DISPONIBLE EN 2 COLORES (NATUREL OU NOIR)

Consumi tessuto / Fabric consumption / Tissu nécessaire ml 1,60

Consumi pelle / Consumption leather / Cuir nécessaire mq 2,30



Omologazione ministeriale al fuoco in classe 11M con rivestimento PLANET o BINGO ELAST / MIRAGE e poliuretano ignifugo (+6% da listino)

Fireproof Italian Ministry homologation in 11M class with upholstery PLANET or BINGO ELAST / MIRAGE and fire retardant polyurethane (+6% to price list)
Certification ministérielle contre le feu en classe 11M avec revêtement PLANET ou BINGO ELAST / MIRAGE et polyuréthane ignifuge (+ 6% à partir de la liste de prix)









Ignifugo + extra 6% da listino prezzi

Fireproof + extra 6% to price list
Non feu + extra 6% sur le tarif

Eon

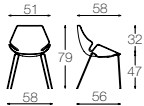
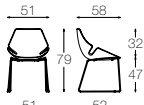
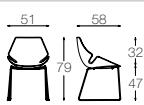
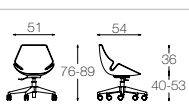
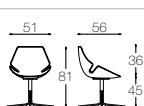
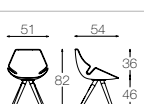
- **Struttura telaio in metallo**
Metal frame structure
Structure en métal
- **Scocca in poliuretano rigido tech**
Shell in tech polyurethane
Coque en poliuréthane rigide tech

EN-1728 EN 15373

			Prezzo unitario € Unit price € Prix Unitaire €	 mc	 kg	
POLTRONCINA ARMCHAIR PETITE CHAISE						
EOQCR	Telaio 4 gambe cromato Chromed 4 legs frame Piètement 4 pieds chromé		239	0.33	9.35	max 3 pz 3 pcs 3 pc
EOCCR	Telaio slitta cromato Chromed sled frame Piètement luge chromé		306	0.27	10.95	
EOCNR	Telaio slitta nero Black sled frame Piètement luge noir		295	0.27	10.95	
EOGAL	Base alluminio, regolazione a gas Aluminium base, gaslift Piètement 5 branches aluminium, gaz		294	0.18	11.6	
EOMCR	Telaio cromato tubolare girevole Chromed frame, swivel Piètement chromé pivotant		331	0.27	13.35	
EOQWFB	Telaio 4 gambe in legno di frassino 4 legs ash wood frame Piètement 4 pieds en bois de frêne		381	0.27	10.25	
Accessori / Accessories / Accessoires			Prezzo unitario € Unit price € Prix Unitaire €			
EOBRCR	Coppia braccioli cromati Chromed arms Pair d'accoudoirs chromé		106			
EOBRNR	Coppia braccioli neri Black arms Pair d'accoudoir noir		76			
EOBRCDT	Bracciolo singolo destro cromato per tavoletta Chromed single right arm with tablet Accoudoir droit chromé pour tablette		89			
SUAT	Tavoletta scrittoio nylon nero Black nylon writing desk Tablette écriteiro en nylon noir		38			



COLORI DISPONIBILI: ANTRACITE Simil RAL 7024 O BIANCO Simil RAL 9016 . BICOLOR: BIANCO Simil RAL 9016 FRONTE E TORTORA RAL 1019 RETRO / PANNA RAL 1013 FRONTE E MOKA Simil RAL 8019 RETRO

AVAILABLE COLORS: ANTRACITE Simil RAL 7024 OR WHITE Simil RAL 9016 . TWO-COLOUR: WHITE Simil RAL 9016 FRONT and BEIGE RAL 1019 BACK / MORY RAL 1013 FRONT and CHOCOLATE Simil RAL 8019 BACK

COLORIS DISPONIBLES: ANTHRACITE Simil RAL 7024 OU BLANC Simil RAL 9016 . BI-COLOR: BLANC Simil RAL 9016 AVANT ET TAUPE RAL 1019 ARRIERE / BEIGE RAL 1013 AVANT ET MOKA Simil RAL 8019 ARRIERE

Eon stool

- **Struttura telaio in metallo**
Metal frame structure
Structure en métal
- **Scocca in poliuretano rigido tech**
Shell in tech polyurethane
Coque en poliuréthane rigide tech

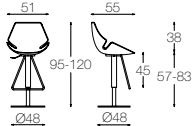
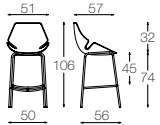
		Prezzo unitario € Unit price € Prix Unitaire €	 mc	 kg
SGABELLO STOOL TABOURET				
EOSGCR	<p>Elevazione a gas, telaio cromato Gaslift regulation, chromed frame Elevation gaz, structure chromé</p> 	518	0.31	22.15
EOSQCR	<p>Telaio cromato fisso Chromed fixed frame Piètement chromé fixe</p> 	306	0.44	11.35









COLORI DISPONIBILI: ANTRACITE Simil RAL 7024 O BIANCO Simil RAL 9016 . BICOLOR: BIANCO Simil RAL 9016 FRONTE E TORTORA RAL 1019 RETRO / PANNA RAL 1013 FRONTE E MOKA Simil RAL 8019 RETRO

AVAILABLE COLORS: ANTHRACITE Simil RAL 7024 OR WHITE Simil RAL 9016 . TWO-COLOUR: WHITE Simil RAL 9016 FRONT and BEIGE RAL 1019 BACK / MORY RAL 1013 FRONT and CHOCOLATE Simil RAL 8019 BACK

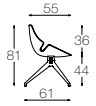
COLORIS DISPONIBLES: ANTHRACITE Simil RAL 7024 OU BLANC Simil RAL 9016 . BI-COLOR: BLANC Simil RAL 9016 AVANT ET TAUPE RAL 1019 ARRIERE / BEIGE RAL 1013 AVANT ET MOKA Simil RAL 8019 ARRIERE

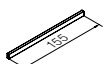
Eon panca

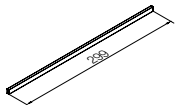
- **Struttura telaio in metallo**
Metal frame structure
Structure en métal
- **Scocca in poliuretano rigido tech**
Shell in tech polyurethane
Coque en poliuréthane rigide tech

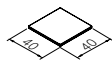
				Prezzo unitario € Unit price € Prix Unitaire €			
				mc	kg		
PANCA IN POLIURETANO BENCH IN POLYURETHANE BANC EN POLYURETHANE							
EOP01	Seduta per panca Bench shell Coque pour poutre			258	0.21	11.6	
Accessori / Accessories / Accessoires				Prezzo unitario € Unit price € Prix Unitaire €			
PANCA BENCH BANC							
BONPT2	Trave 2 posti 2 seater beam Poutre 2 places			37			
BONPT3	Trave 3 posti 3 seater beam Poutre 3 places			48			
CPPT4	Trave 4 posti 4 seater beam Poutre 4 places			61			
CPPT5	Trave 5 posti (Obbligatorio utilizzare 3 gambe) 5-seater beam (Imperative to use 3 legs) Poutre 5 places (obligatoire mettre 3 pieds)			72			
CPPGAL	Elemento terminale alluminio - Gamba (1 pz) Aluminium leg (1 pc) Pied en aluminium (1 pièce)			100			
BONPPA	Piano appoggio nero Black table for bench Table noir pour poutre			93			

COLORI DISPONIBILI: ANTRACITE Simil RAL 7024 O BIANCO Simil RAL 9016 . BICOLOR: BIANCO Simil RAL 9016 FRONTE E TORTORA RAL 1019 RETRO / PANNA RAL 1013 FRONTE E MOKA Simil RAL 8019 RETRO

AVAILABLE COLORS: ANTRACITE Simil RAL 7024 OR WHITE Simil RAL 9016 .TWO-COLOUR: WHITE Simil RAL 9016 FRONT and BEIGE RAL 1019 BACK / MORY RAL 1013 FRONT and CHOCOLATE Simil RAL 8019 BACK

COLORIS DISPONIBLES: ANTHRACITE Simil RAL 7024 OU BLANC Simil RAL 9016 . BI-COLOR: BLANC Simil RAL 9016 AVANT ET TAUPE RAL 1019 ARRIERE / BEIGE RAL 1013 AVANT ET MOKA Simil RAL 8019 ARRIERE

Eon riv

EN-1728 EN 15373

- **Struttura telaio in metallo**
Metal frame structure
Structure en métal
- **Imbottitura in schiumato a freddo**
Injected foam padding
Rembourrage en mousse moulée à froid
- **Struttura scocca in acciaio**
Shell in steel
Structure coque en acier

			Cat. F	Cat. G	Cat. S	Cat. TOP	Cat. EXTRA	Pelle Leather Cuir FIESTA	Pelle Leather Cuir NUVOLA	mc	kg
POLTRONCINA RIVESTITA UPHOLSTERED ARMCHAIR PETITE CHAISE REVETUE											
EOQCRRV	Telaio cromato 4 gambe Chromed 4 legs frame Piètement 4 pieds chromé		442	449	485	491	516	550	593	0.33	10.05
EOCCRRV	Telaio cromato slitta Chromed sled frame Piètement luge chromé		499	507	545	550	577	612	657	0.27	11.75
EOCNRRV	Telaio nero slitta Black sled frame Piètement luge noir		487	495	532	538	564	601	646	0.27	11.75
EOMCRRV	Telaio cromato tubolare girevole Tubular chromed frame, swivel Piètement tubulaire cromé		578	584	620	625	652	686	728	0.27	14.05
EOGALRV	Base alluminio, elevazione gas Aluminium base, gaslift Piètement 5 branche aluminium, roulettes, elevation gaz		482	488	525	529	556	568	632	0.18	12.4
EOQWFBRV	Telaio 4 gambe in legno di frassino 4 legs ash wood frame Piètement 4 pieds en bois de frêne		572	579	615	620	646	679	722	0.27	11.25

Consumi tessuto / Consumption fabric / Tissu nécessaire **ml 1,10**

Consumi pelle / Consumption leather / Cuir nécessaire **mq 1,80**

Consumi BICOLOR INTERNO tessuto / Consumption BICOLOR INSIDE fabric / Tissu nécessaire DEUX COULEURS interieur **ml 0,55**

Consumi BICOLOR INTERNO pelle / Consumption BICOLOR INSIDE leather / Cuir nécessaire DEUX COULEURS interieur **mq 0,85**

Consumi BICOLOR ESTERNO tessuto / Consumption BICOLOR OUTSIDE fabric / Tissu nécessaire DEUX COULEURS exterior **ml 0,65**

Consumi BICOLOR INTERNO pelle / Consumption BICOLOR INSIDE leather / Cuir nécessaire DEUX COULEURS interieur **mq 1,00**



Omologazione ministeriale al fuoco in classe 1IM con rivestimento PLANET o BINGO ELAST / MIRAGE e poliuretano ignifugo (+6% da listino)

Fireproof Italian Ministry homologation in 1IM class with upholstery PLANET or BINGO ELAST / MIRAGE and fire retardant polyurethane (+6% to price list)

Certification Italienne contre le feu en classe 1IM avec revêtement PLANET ou BINGO ELAST/MIRAGE et polyuréthane ignifuge (+6% sur le tarif)



Ignifugo + extra 6% da listino prezzi





Fireproof + extra 6% to price list

Non feu + extra 6% sur le tarif

Eon riv

EN-1728 EN 15373

- **Struttura telaio in metallo**
Metal frame structure
Structure en métal
- **Imbottitura in schiumato a freddo**
Injected foam padding
Rembourrage en mousse moulée à froid
- **Struttura scocca in acciaio**
Shell in steel
Structure coque en acier

Accessori / Accessories / Accessoires			Prezzo unitario € Unit price € Prix Unitaire €
EOBRCR	Coppia braccioli cromati Chromed arms Pair d'accoudoirs chromé		106
EOBRNR	Coppia braccioli neri Black arms Pair d'accoudoir noir		76
EOBRCDT	Bracciolo singolo destro cromato per tavoletta Chromed single right arm with tablet Accoudoir droit chromé pour tablette		89
SUAT	Tavoletta scrittoio nylon nero Black nylon writing desk Tablette écrivain en nylon noir		38
EOACOX	Trapuntatura Quilted padding Matelassage		70

Consumi tessuto / Consumption fabric / Tissu nécessaire **ml 1,10**

Consumi pelle / Consumption leather / Cuir nécessaire **mq 1,80**

Consumi BICOLOR INTERNO tessuto / Consumption BICOLOR INSIDE fabric / Tissu nécessaire DEUX COULEURS interieur **ml 0,55**

Consumi BICOLOR INTERNO pelle / Consumption BICOLOR INSIDE leather / Cuir nécessaire DEUX COULEURS interieur **mq 0,85**

Consumi BICOLOR ESTERNO tessuto / Consumption BICOLOR OUTSIDE fabric / Tissu nécessaire DEUX COULEURS exterior **ml 0,65**

Consumi BICOLOR INTERNO pelle / Consumption BICOLOR INSIDE leather / Cuir nécessaire DEUX COULEURS interieur **mq 1,00**



Omologazione ministeriale al fuoco in classe 1IM con rivestimento PLANET o BINGO ELAST / MIRAGE e poliuretano ignifugo (+6% da listino)

Fireproof Italian Ministry homologation in 1IM class with upholstery PLANET or BINGO ELAST / MIRAGE and fire retardant polyurethane (+6% to price list)

Certification Italienne contre le feu en classe 1IM avec revêtement PLANET ou BINGO ELAST/MIRAGE et polyuréthane ignifuge (+6% sur le tarif)





Ignifugo + extra 6% da listino prezzi

Fireproof + extra 6% to price list

Non feu + extra 6% sur le tarif

Eon riv stool

- **Struttura telaio in metallo**
Metal frame structure
Structure en métal
- **Imbottitura in schiumato a freddo**
Injected foam padding
Rembourrage en mousse moulée à froid
- **Struttura scocca in acciaio**
Shell in steel
Structure coque en acier

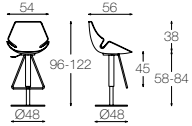
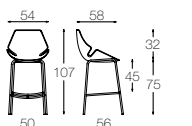
			Cat. F	Cat. G	Cat. S	Cat. TOP	Cat. EXTRA	Pelle Leather Cuir FIESTA	Pelle Leather Cuir NUVOLA	 mc	 kg
SGABELLO STOOL TABOURET											
EOSGCRRV	Elevazione a gas, telaio cromato Gaslift regulation, chromed frame Elevation gaz, structure chromé		640	647	682	686	711	743	784	0.31	22.85
EOSQCRRV	Telaio cromato fisso Chromed fixed frame Piètement chromé fixe		471	477	512	517	542	575	616	0.44	12.05

Consumi tessuto / Consumption fabric / Tissu nécessaire **ml 1,10**

Consumi pelle / Consumption leather / Cuir nécessaire **mq 1,80**

Consumi BICOLOR INTERNO tessuto / Consumption BICOLOR INSIDE fabric / Tissu nécessaire DEUX COULEURS interieur **ml 0,55**

Consumi BICOLOR INTERNO pelle / Consumption BICOLOR INSIDE leather / Cuir nécessaire DEUX COULEURS interieur **mq 0,85**

Consumi BICOLOR ESTERNO tessuto / Consumption BICOLOR OUTSIDE fabric / Tissu nécessaire DEUX COULEURS exterior **ml 0,65**

Consumi BICOLOR INTERNO pelle / Consumption BICOLOR INSIDE leather / Cuir nécessaire DEUX COULEURS interieur **mq 1,00**



Omologazione ministeriale al fuoco in classe 1IM con rivestimento PLANET o BINGO ELAST / MIRAGE e poliuretano ignifugo (+6% da listino)

Fireproof Italian Ministry homologation in 1IM class with upholstery PLANET or BINGO ELAST / MIRAGE and fire retardant polyurethane (+6% to price list)

Certification Italienne contre le feu en classe 1IM avec revêtement PLANET ou BINGO ELAST/MIRAGE et polyuréthane ignifuge (+6% sur le tarif)



Ignifugo + extra 6% da listino prezzi





Fireproof + extra 6% to price list

Non feu + extra 6% sur le tarif

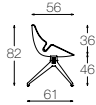
Eon riv panca

- **Struttura telaio in metallo**
Metal frame structure
Structure en métal
- **Imbottitura in schiumato a freddo**
Injected foam padding
Rembourrage en mousse moulée à froid
- **Struttura scocca in acciaio**
Shell in steel
Structure coque en acier

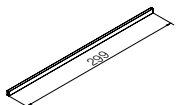
			Cat. F	Cat. G	Cat. S	Cat. TOP	Cat. EXTRA	Pelle Leather Cuir FIESTA	Pelle Leather Cuir NUVOLA	mc	kg
PANCA RIVESTITA UPHOLSTERED BENCH BANC REVETUE											
EOP01RV	Seduta panca Bench shell Coque pour poutre		426	433	469	473	500	534	577	0.21	12.4

Accessori / Accessories / Accessoires		Prezzo unitario € Unit price € Prix Unitaire €	
PANCA BENCH BANC			
BONPT2	Trave 2 posti 2 seater beam Poutre 2 places		37
BONPT3	Trave 3 posti 3 seater beam Poutre 3 places		48
CPPT4	Trave 4 posti 4 seater beam Poutre 4 places		55
CPPT5	Trave 5 posti (Obbligatorio utilizzare 3 gambe) 5-seater beam (Imperative to use 3 legs) Poutre 5 places (obligatoire mettre 3 pieds)		65
CPPGAL	Elemento terminale alluminio - Gamba (1 pz) Aluminium leg (1 pc) Pied en aluminium (1 pièce)		100
BONPPA	Piano appoggio nero Black table for bench Table noir pour poutre		93

Consumi tessuto / Consumption fabric / Tissu nécessaire **ml 1,10**

Consumi pelle / Consumption leather / Cuir nécessaire **mq 1,80**

Consumi BICOLOR INTERNO tessuto / Consumption BICOLOR INSIDE fabric / Tissu nécessaire DEUX COULEURS interieur **ml 0,55**

Consumi BICOLOR INTERNO pelle / Consumption BICOLOR INSIDE leather / Cuir nécessaire DEUX COULEURS interieur **mq 0,85**

Consumi BICOLOR ESTERNO tessuto / Consumption BICOLOR OUTSIDE fabric / Tissu nécessaire DEUX COULEURS exterieur **ml 0,65**

Consumi BICOLOR INTERNO pelle / Consumption BICOLOR INSIDE leather / Cuir nécessaire DEUX COULEURS interieur **mq 1,00**



Omologazione ministeriale al fuoco in classe 1IM con rivestimento PLANET o BINGO ELAST / MIRAGE e poliuretano ignifugo (+6% da listino)

Fireproof Italian Ministry homologation in 1IM class with upholstery PLANET or BINGO ELAST / MIRAGE and fire retardant polyurethane (+6% to price list)

Certification Italienne contre le feu en classe 1IM avec revêtement PLANET ou BINGO ELAST/MIRAGE et polyuréthane ignifuge (+6% sur le tarif)



Ignifugo + extra 6% da listino prezzi

Fireproof + extra 6% to price list

Non feu + extra 6% sur le tarif

- **Struttura telaio in metallo**
Metal frame structure
Structure en métal
- **Imbottitura in poliuretano espanso**
Polyurethane foam padding
Rembourrage en polyurethane
- **Struttura scocca in acciaio e legno**
Shell in steel and wood
Structure coque en acier et bois

			Cat. F	Cat. G	Cat. S	Cat. TOP	Cat. EXTRA	Pelle Leather Cuir FIESTA	Pelle Leather Cuir NUVOLA	mc	kg
POLTRONCINA ARMCHAIR PETITE CHAISE											
LFP CNR	Telaio slitta verniciato nero Sled black lacquered frame Piètement luge noir		435	445	490	500	550	620	680	0.33	12
LFP QWNT	Telaio 4 gambe fisso, in frassino naturale 4 legs fixed frame in ash wood Piètement 4 pieds en bois de frêne naturel		515	520	570	575	635	675	730	0.33	11
LFP QWNR	Telaio 4 gambe fisso, in frassino verniciato nero, poro aperto 4 legs fixed frame in black lacquered ash wood Piètement 4 pieds en bois de frêne laqué noir		515	520	570	575	635	675	730	0.33	11
LFP 4WNT	Telaio 4 gambe girevole, in frassino naturale 4 legs swivel frame in natural ash wood Piètement pivotant en bois de frêne naturel		675	680	730	735	795	835	890	0.33	12
LFPTG_	Telaio 4 razze girevole, in polipropilene bianco (BC) o nero (NR) 4 star swivel frame in white (BC) or black (NR) polypropylene Piètement 4 branches pivotant en polypropylène blanc (BC) ou noir (NR)		465	475	520	530	590	630	685	0.33	11
LFPRG_R	Telaio 4 razze girevole, in alluminio lucido (AL), verniciato bianco (BC) o nero (NR) su ruote 4 star swivel frame in polished aluminium (AL) or lacquered in white (BC) or black (NR) on castors Piètement 4 branches pivotant en aluminium poli (AL) ou blanc (BC) ou noir (NR) sur roulettes		520	525	575	580	640	680	740	0.33	11
LFPRG_P	Telaio 4 razze girevole, in alluminio lucido (AL), verniciato bianco (BC) o nero (NR) su piedini 4 star swivel frame in polished aluminium (AL) or lacquered in white (BC) or black (NR) on glides Piètement 4 branches pivotant en aluminium poli (AL) ou blanc (BC) ou noir (NR) sur patins		520	525	575	580	640	680	740	0.33	11

Consumi tessuto / Consumption fabric / Tissu nécessaire **ml 0,65**

Consumi pelle / Consumption leather / Cuir nécessaire **mq 1,00**



Omologazione ministeriale al fuoco in classe 1M con rivestimento PLANET o BINGO ELAST / MIRAGE e poliuretano ignifugo (+6% da listino) IN CORSO

Fireproof Italian Ministry homologation in 1M class with upholstery PLANET or BINGO ELAST / MIRAGE and fire retardant polyurethane (+6% to price list) ONGOING
Certification Italienne contre le feu en classe 1M avec revêtement PLANET ou BINGO ELAST/MIRAGE et polyuréthane ignifuge (+6% sur le tarif) en course



Ignifugo + extra 6% da listino prezzi

Fireproof + extra 6% to price list
Non feu + extra 6% sur le tarif

- **Struttura telaio in metallo**
Metal frame structure
Structure en métal
- **Imbottitura in poliuretano espanso**
Polyurethane foam padding
Rembourrage en polyuréthane
- **Struttura scocca in acciaio e legno**
Shell in steel and wood
Structure coque en acier et bois

SGABELLO STOOL TABOURET		Cat. F	Cat. G	Cat. S	Cat. TOP	Cat. EXTRA	Pelle Leather Cuir FIESTA	Pelle Leather Cuir NUVOLA	mc	kg
LFSC_	Telaio slitta verniciato bianco (BC) o nero (NR) Sled frame white (BC) or black (NR) painted Piètement luge blanc (BC) ou noir (NR)		285	290	320	325	365	390	0.22	8
LFSBQWNT	Telaio 4 gambe in frassino naturale, versione bassa 4 legs frame in natural ash wood, low version Piètement 4 pieds en bois de frêne naturel, version bas		390	400	435	440	480	505	0.22	7
LFSBQWNR	Telaio 4 gambe in frassino verniciato nero poro aperto, versione bassa 4 legs frame in black lacquered ash wood, low version Piètement 4 pieds en bois de frêne laqué noir, version bas		390	400	435	440	480	505	0.22	7
LFSAQWNT	Telaio 4 gambe in frassino naturale 4 legs frame in natural ash wood Piètement 4 pieds en bois de frêne naturel		400	410	445	450	490	515	0.22	7
LFSAQWNR	Telaio 4 gambe in frassino verniciato nero poro aperto 4 legs frame in black lacquered ash wood Piètement 4 pieds en bois de frêne laqué noir		400	410	445	450	490	515	0.22	7
LFSGGNR	Telaio girevole verniciato nero, alzata a gas e poggiapiedi Swivel frame in steel black lacquered, gaslift and footrest Piètement pivotant en acier laqué noir, avec gaz		530	535	585	590	630	655	0.22	11

Consumi tessuto / Consumption fabric / Tissu nécessaire **ml 0,65**

Consumi pelle / Consumption leather / Cuir nécessaire **m² 1,00**



Omologazione ministeriale al fuoco in classe 11M con rivestimento PLANET o BINGO ELAST / MIRAGE e poliuretano ignifugo (+6% da listino) IN CORSO

Fireproof Italian Ministry homologation in 11M class with upholstery PLANET or BINGO ELAST / MIRAGE and fire retardant polyurethane (+6% to price list) ONGOING

Certification Italienne contre le feu en classe 11M avec revêtement PLANET ou BINGO ELAST/MIRAGE et polyuréthane ignifuge (+6% sur le tarif) en course



Ignifugo + extra 6% da listino prezzi



Fireproof + extra 6% to price list

Non feu + extra 6% sur le tarif

Margarita

EN-1728

- **Imbottitura in poliuretano espanso**
Polyurethane foam padding
Rembourrage en mousse de polyuréthane
- **Struttura in polietilene 100% riciclabile**
Polyethylene 100% recyclable structure
Structure en polyéthylène recyclable 100%

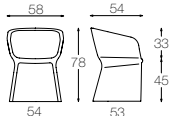

	Prezzo unitario € Unit price € Prix Unitaire €	 mc	 kg
POLTRONCINA in polietilene colorato ARMCHAIR in colored polyethylene PETITE CHAISE EN POLYETHYLENE MAPLPE 	272	0.29	11

DISPONIBILE NEI SEGUENTI COLORI DA SEGNARE A COMPLETAMENTO NEL CODICE: ANTRACITE (AN) Simil PANTONE 425 C, BIANCO (BC) Simil RAL 9010, GIALLO (GI) Simil PANTONE 130 EC, GRIGIO (GR) Simil PANTONE 413 EC, ROSSO (RO) Simil PANTONE 201C, VERDE (VE) Simil PANTONE 583C
 AVAILABLE IN DIFFERENT COLORS - TO FILL IN THE CODE: DARK GREY (AN) Simil PANTONE 425 C, WHITE (BC) Simil RAL 9010, YELLOW (GI) Simil PANTONE 130 EC, GREY (GR) Simil PANTONE 413 EC, RED (RO) Simil PANTONE 201C, GREEN (VE) Simil PANTONE 583C
 COLORIS DISPONIBLES - A COMPLETER DANS LE CODE: ANTHRACITE (AN) Simil PANTONE 425 C, BLANC (BC) Simil RAL 9010, JAUNE (GI) Simil PANTONE 130 EC, GRIS (GR) Simil PANTONE 413 EC, ROUGE (RO) Simil PANTONE 201C, VERT (VE) Simil PANTONE 583C

Accessori / Accessories / Accessoires	Cat. F	Cat. G	Cat. S	Cat. TOP	Cat. EXTRA	Pelle Leather Cuir FIESTA	Pelle Leather Cuir NUVOLA
MAACCU CUSCINO IMBOTTITO E RIVESTITO CUSHION PADDED AND UPHOLSTERED COUSSIN D'ASSISE REVETU	85	91	108	113	130	164	193

Consumi cuscino tessuto / Cushion fabric consumption / Tissu nécessaire coussin **ml 0,70**

Consumi cuscino pelle / Cushion leather consumption / Cuir nécessaire coussin **mq 1,00**

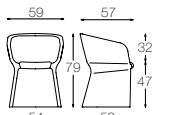
	Cat. F	Cat. G	Cat. S	Cat. TOP	Cat. EXTRA	Pelle Leather Cuir FIESTA	Pelle Leather Cuir NUVOLA	 mc	 kg
POLTRONCINA IMBOTTITA E RIVESTITA ARMCHAIR PADDED AND UPHOLSTERED PETITE CHAISE REVETUE MAPLRV 	520	554	670	681	774	901	1.040	0.29	12.4

SU RICHIESTA POSSIBILITÀ DELLA VERSIONE CON RUOTE

ON REQUEST IT IS POSSIBLE TO HAVE THE MODEL WITH CASTORS

SUR DEMANDE VERSION AVEC ROULETTES

Omologazione ministeriale al fuoco in classe 1IM con rivestimento PLANET o BINGO ELAST / MIRAGE e poliuretano ignifugo (+6% da listino)

Omologazione ministeriale al fuoco in classe 1IM con rivestimento PLANET o BINGO ELAST / MIRAGE e poliuretano ignifugo (+6% da listino)

Consumi tessuto / Consumption fabric / Tissu nécessaire **ml 3,60**

Consumi pelle / Consumption leather / Cuir nécessaire **mq 5,00**



Imbottitura ignifuga +6% da listino solo su versioni con cuscino sedile e totalmente rivestita

Fireproof foam +6% to pricelist only on models with seat cushion and completely upholstered

Certification Italienne contre le feu en classe 1IM avec revêtement PLANET ou BINGO ELAST/MIRAGE et polyuréthane ignifuge (+6% sur le tarif)

Miss

EN-16139

EN-1728

- **Struttura telaio in metallo**
Metal frame structure
Structure en métal
- **Imbottitura in poliuretano espanso**
Polyurethane foam padding
Rembourrage en mousse de polyuréthane
- **Scocca in multistrato di faggio**
Shell in multilayer beech wood
Coque en bois multiplis

		Cat. F	Cat. G	Cat. S	Cat. TOP	Cat. EXTRA	Pelle Leather Cuir FIESTA	Pelle Leather Cuir NUVOLA	mc	kg		
POLTRONCINA ARMCHAIR PETITE CHAISE												
MSC_01	Telaio slitta cromata (CR) o nera (NR), senza braccioli Chromed (CR) or Black (NR) sled frame, without arms Pièment luge, sans accoudoirs chromé (CR) ou noir (NR)		326	335	376	384	415	453	505	0.33	11.35	max 5 pz 5 pcs 5 pc
MSCCR95	Telaio slitta cromata, con braccioli Chromed sled frame, with arms Pièment luge, avec accoudoirs		384	392	434	440	470	510	562	0.33	11.85	
MSQCR01	Telaio 4 gambe cromato, senza braccioli 4 legs chromed frame, without arms Pièment 4 pieds chromé, sans accoudoirs		372	375	409	429	448	475	552	0.33	9.65	max 4 pz 4 pcs 4 pc
MSQCR95	Telaio 4 gambe cromato, con braccioli 4 legs chromed frame, with arms Pièment 4 pieds chromé, avec accoudoirs		441	459	493	512	534	561	639	0.33	10.15	
MSGCR01	Telaio tubolare cromato, girevole, senza braccioli Tubular chromed frame, swivel, without arms Pièment tubulaire chromé, pivotant sans accoudoirs		469	476	517	535	567	699	817	0.27	13.65	
MSGCR95	Telaio tubolare cromato, girevole, con braccioli Tubular chromed frame, swivel, with arms Pièment tubulaire chromé, pivotant avec accoudoirs		520	529	563	586	618	748	864	0.33	14.15	
MSLCR01	Telaio 4 lame girevole, meccanismo di ritorno, senza braccioli 4 blades aluminium frame, return mechanism, without arms Pièment 4 branches, pivotant avec retour sans accoudoirs		475	482	518	536	567	660	751	0.21	11.4	
MSLCR95	Telaio 4 lame girevole, meccanismo di ritorno, con braccioli 4 blades aluminium frame, return mechanism, with arms Pièment 4 branches, pivotant avec retour avec accoudoirs		529	537	571	592	620	721	813	0.21	12.35	
MSPAL01	Base 5 razze alluminio, gas, senza braccioli 5 star aluminium base, gaslift, without arms Pièment 5 branches, elevation gaz, sans accoudoirs		387	397	433	453	485	640	757	0.21	11.8	
MSPAL95	Base 5 razze alluminio, gas, con braccioli 5 star aluminium base, gaslift, with arms Pièment 5 branches, elevation gaz, avec accoudoirs		433	441	477	501	532	688	809	0.21	12.3	

Miss

EN-16139

EN-1728

- **Imbottitura in poliuretano espanso**
Polyurethane foam padding
Rembourrage en mousse de polyuréthane
- **Scocca in multistrato di faggio**
Shell in multilayer beech wood
Coque en bois multiplis
- **Base alluminio**
Aluminium base
Piètement en aluminium

	Cat. F	Cat. G	Cat. S	Cat. TOP	Cat. EXTRA	Pelle Leather Cuir FIESTA	Pelle Leather Cuir NUVOLA	mc	kg	
POLTRONCINA ARMCHAIR PETITE CHAISE										
MSKAL01										
<p>Base 5 razze alluminio, gas knee-tilt, senza braccioli</p> <p>5 star aluminium base, gaslift knee-tilt, without arms</p> <p>Piètement 5 branches, elevation gaz knee-tilt, sans accoudoirs</p>										
MSKAL95										
<p>Base 5 razze alluminio, gas knee-tilt, con braccioli</p> <p>5 star aluminium base, gaslift knee-tilt, with arms</p> <p>Piètement 5 branches, elevation gaz knee-tilt, avec accoudoirs</p>										
MSRAL01P										
<p>Base 4 razze piramidale alluminio su piedini, senza braccioli</p> <p>Pyramidal 4 star polished aluminium base on glides, without arms</p> <p>Piètement 4 branches pyramidal aluminium poli sur patins, sans accoudoirs</p>										
MSR_01P										
<p>Base 4 razze piramidale alluminio verniciata nera (NR) o bianca (BC) su piedini, senza braccioli</p> <p>Pyramidal 4 star aluminium black (NR) or white (BC) lacquered base on glides, without arms</p> <p>Piètement 4 branches pyramidal aluminium laqué noir (NR) ou blanc (BC) sur patins, sans accoudoirs</p>										
MSRAL01										
<p>Base 4 razze piramidale alluminio lucida su ruote, senza braccioli</p> <p>Pyramidal 4 star polished aluminium base on castors, without arms</p> <p>Piètement 4 branches pyramidal aluminium poli sur roulettes, sans accoudoirs</p>										
MSR_01										
<p>Base 4 razze piramidale alluminio verniciata nera (NR) o bianca (BC) su ruote, senza braccioli</p> <p>Pyramidal 4 star aluminium black (NR) or white (BC) lacquered base on castors, without arms</p> <p>Piètement 4 branches pyramidal aluminium laqué noir (NR) ou blanc (BC) sur roulettes, sans accoudoirs</p>										

EXTRA IMBOTTITURA +3% DA LISTINO PREZZI

EXTRA PADDING +3% TO PRICE LIST
EXTRA REMBOURRAGE +3% SUR TARIF

SPECIFICARE SEMPRE NELL'ORDINE: CON O SENZA CUCITURE

PLEASE SPECIFY ALWAYS: WITH OR WITHOUT HORIZONTAL STITCHINGS
SPECIFICIER DANS LA COMMANDE: AVEC OU PAS COUTURES

Consumi tessuto / Consumption fabric / Tissu nécessaire ml 1,20

Consumi pelle / Consumption leather / Cuir nécessaire mq 2,00



Omologazione ministeriale al fuoco in classe 11M con rivestimento PLANET o BINGO ELAST / MIRAGE e poliuretano ignifugo (+6% da listino)

Fireproof Italian Ministry homologation in 11M class with upholstery PLANET or BINGO ELAST / MIRAGE and fire retardant polyurethane (+6% to price list)
Certification Italienne contre le feu en classe 11M avec revêtement PLANET ou BINGO ELAST/MIRAGE et polyuréthane ignifuge (+6% sur le tarif)



Ignifugo + extra 6% da listino prezzi

Fireproof + extra 6% to price list
Non feu + extra 6% sur le tarif

Miss

EN-16139

EN-1728

- **Imbottitura in poliuretano espanso**
Polyurethane foam padding
Rembourrage en mousse de polyuréthane
- **Scocca in multistrato di faggio**
Shell in multilayer beech wood
Coque en bois multiples
- **Base alluminio**
Aluminium base
Piètement en aluminium

Accessori / Accessories / Accessoires			Prezzo unitario € Unit price € Prix Unitaire €
MSBRCR	Coppia braccioli cromati Chromed pair of arms Pair d'accoudoirs chromés		66
MSBRNR	Coppia braccioli verniciati neri Black lacquered pair of arms Pair d'accoudoirs noir		55
MSBRBC	Coppia braccioli verniciati bianchi White lacquered pair of arms Pair d'accoudoirs blanc		55

EXTRA IMBOTTITURA +3% DA LISTINO PREZZI

EXTRA PADDING +3% TO PRICE LIST
EXTRA REMBOURRAGE +3% SUR TARIF

SPECIFICARE SEMPRE NELL'ORDINE: CON O SENZA CUCITURE

PLEASE SPECIFY ALWAYS: WITH OR WITHOUT HORIZONTAL STITCHINGS
SPECIFICIER DANS LA COMMANDE: AVEC OU PAS COUTURES

Consumi tessuto / Consumption fabric / Tissu nécessaire **ml 1,20**

Consumi pelle / Consumption leather / Cuir nécessaire **mq 2,00**



Omologazione ministeriale al fuoco in classe 1IM con rivestimento PLANET o BINGO ELAST / MIRAGE e poliuretano ignifugo (+6% da listino)

Fireproof Italian Ministry homologation in 1IM class with upholstery PLANET or BINGO ELAST / MIRAGE and fire retardant polyurethane (+6% to price list)
Certification Italienne contre le feu en classe 1IM avec revêtement PLANET ou BINGO ELAST/MIRAGE et polyuréthane ignifuge (+6% sur le tarif)



Ignifugo + extra 6% da listino prezzi

Fireproof + extra 6% to price list
Non feu + extra 6% sur le tarif

Miss stool

- **Struttura in metallo**
Metal frame structure
Structure en métal
- **Imbottitura in poliuretano espanso**
Polyurethane foam padding
Rembourrage en mousse de polyuréthane
- **Scocca in multistrato di faggio**
Shell in multilayer beech wood
Coque en bois multiplis

						Pelle Leather Cuir FIESTA	Pelle Leather Cuir NUVOLA	mc	kg	
		Cat. F	Cat. G	Cat. S	Cat. TOP	Cat. EXTRA				
SGABELLO STOOL TABOURET										
MSZCCR01	Senza braccioli Without arms Sans accoudoirs									
		416	426	474	480	514	516	576	0.44	13.55
										max 5 pz 5 pcs 5 pc
MSZCCR95	Con braccioli With arms Avec accoudoirs									
		480	490	536	543	579	581	639	0.44	14.05

EXTRA IMBOTTITURA +3% DA LISTINO PREZZI

EXTRA PADDING +3% TO PRICE LIST
EXTRA REMBOURRAGE +3% SUR TARIF

SPECIFICARE SEMPRE NELL'ORDINE: CON O SENZA CUCITURE

PLEASE SPECIFY ALWAYS: WITH OR WITHOUT HORIZONTAL STITCHINGS
SPECIFICIER DANS LA COMMANDE: AVEC OU PAS COUTURES

Consumi tessuto / Consumption fabric / Tissue nécessaire **ml 1,20**

Consumi pelle / Consumption leather / Cuir nécessaire **mq 2,00**



Omologazione ministeriale al fuoco in classe 1IM con rivestimento PLANET o BINGO ELAST / MIRAGE e poliuretano ignifugo (+6% da listino)

Fireproof Italian Ministry homologation in 1IM class with upholstery PLANET or BINGO ELAST / MIRAGE and fire retardant polyurethane (+6% to price list)
Certification Italienne contre le feu en classe 1IM avec revêtement PLANET ou BINGO ELAST/MIRAGE et polyuréthane ignifuge (+6% sur le tarif)









Ignifugo + extra 6% da listino prezzi

Fireproof + extra 6% to price list
Non feu + extra 6% sur le tarif

Miss panca

- **Struttura telaio portante in metallo**
Metal frame
Structure portante en métal
- **Imbottitura in poliuretano espanso**
Polyurethane foam padding
Rembourrage en mousse de polyuréthane
- **Scocca in multistrato di faggio**
Shell in multilayer beech wood
Coque en bois multiplis

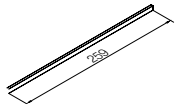
			Cat. F	Cat. G	Cat. S	Cat. TOP	Cat. EXTRA	Pelle Leather Cuir FIESTA	Pelle Leather Cuir NUVOLA	mc	kg
SCocca PANCA BENCH SHELL COQUE POUR POUTRE											
MSP01	Senza braccioli Without arms Sans accoudoirs		318	327	364	382	413	435	517		

Accessori / Accessories / Accessoires			Prezzo unitario € Unit price € Prix Unitaire €	
MSPBR	Coppia braccioli cromati Chromed pair of arms Pair d'accoudoirs chromés			83
BONPT2	Elemento trave 2 p. Two-seater beam Poutre 2 places			37
BONPT3	Elemento trave 3 p. Three-seater beam Poutre 3 places			48
BONPT4	Elemento trave 4 p. Four-seater beam Poutre 4 places			60
BONPT5	Trave 5 posti (Obbligatorio utilizzare 3 gambe) Five-seater beam Poutre 5 places (obligatoire mettre 3 pieds)			71
BONPGSCR	Elemento term. cromato - Gamba (1 pz) Chromed leg (1 pc) Pied chromé (1 pièce)			61
BONPPA	Piano appoggio nero Black table for bench Table noir pour poutre			66

Consumi tessuto / Consumption fabric / Tissue nécessaire ml 1,20

Consumi pelle / Consumption leather / Cuir nécessaire mq 2,00



Omologazione ministeriale al fuoco in classe 1IM con rivestimento PLANET o BINGO ELAST / MIRAGE e poliuretano ignifugo (+6% da listino)

Fireproof Italian Ministry homologation in 1IM class with upholstery PLANET or BINGO ELAST / MIRAGE and fire retardant polyurethane (+6% to price list)
Certification Italienne contre le feu en classe 1IM avec revêtement PLANET ou BINGO ELAST/MIRAGE et polyuréthane ignifuge (+6% sur le tarif)



Ignifugo + extra 6% da listino prezzi

Fireproof + extra 6% to price list
Non feu + extra 6% sur le tarif

Mister

- **Imbottitura poliuretano espanso**
Polyurethane foam padding
Rembourrage en mousse de polyuréthane
- **Scocca in multistrato di faggio**
Shell in multilayer beech wood
Coque en bois multiplis

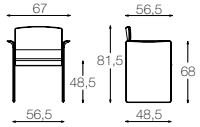
						Pelle Leather Cuir FIESTA	Pelle Leather Cuir NUVOLA	mc	kg	
TRONETTO TUB CHAIR FAUTEUIL										
MRTRPE Con piedini With feet Avec patins chromés		675	697	792	855	941	1.185	1.480	0.33	18.55

SPECIFICARE SEMPRE NELL'ORDINE: CON CUCITURE ORIZZONTALI O A ROMBI

PLEASE SPECIFY ALWAYS: WITH HORIZONTAL OR RHOMBOIDAL STITCHINGS
SPECIFIER SUR COMMANDE: AVEC COUTURES HORIZONTAL OU LOSANGE

Consumi tessuto / Consumption fabric / Tissu nécessaire **mq 2,80**

Consumi pelle / Consumption leather / Cuir nécessaire **mq 4,00**



Omologazione ministeriale al fuoco in classe 1IM con rivestimento PLANET o BINGO ELAST / MIRAGE e poliuretano ignifugo (+6% da listino)

Fireproof Italian Ministry homologation in 1IM class with upholstery PLANET or BINGO ELAST / MIRAGE and fire retardant polyurethane (+6% to price list)
Certification Italienne contre le feu en classe 1IM avec revêtement PLANET ou BINGO ELAST/MIRAGE et polyuréthane ignifuge (+6% sur le tarif)





Ignifugo + extra 6% da listino prezzi

Fireproof + extra 6% to price list
Non feu + extra 6% sur le tarif

Prince

- **Struttura telaio cromato**
Chromed frame
Structure en métal
- **Imbottitura poliuretano espanso**
Polyurethane foam padding
Rembourrage en mousse de polyuréthane
- **Scocca in multistrato di faggio**
Shell in multilayer beech wood
Coque en bois multiplis

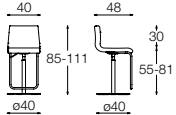
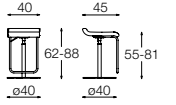
			Cat. F	Cat. G	Cat. S	Cat. TOP	Cat. EXTRA	Pelle Leather Cuir FIESTA	Pelle Leather Cuir NUVOLA	 mc	 kg
SGABELLO, elevazione a gas STOOL, gaslift TABOURET, elevation gaz											
PRAGCR	Schienale alto High backrest Dossier haut		478	483	521	531	559	628	703	0.22	17.15
PRBGCR	Schienale basso Low backrest Dossier bas		454	457	484	493	515	552	598	0.17	16.25

Consumi alto tessuto / High back fabric consumption / Tissu nécessaire dossier haut **ml 0,70**

Consumi alto pelle / High back leather consumption / Cuir nécessaire dossier haut **mq 1,20**

Consumi basso tessuto / Low back fabric consumption / Tissu nécessaire dossier bas **ml 0,50**

Consumi basso pelle / Low back leather consumption / Cuir nécessaire dossier bas **mq 0,80**



Omologazione ministeriale al fuoco in classe 1IM con rivestimento PLANET o BINGO ELAST / MIRAGE e poliuretano ignifugo (+6% da listino)

Fireproof Italian Ministry homologation in 1IM class with upholstery PLANET or BINGO ELAST / MIRAGE and fire retardant polyurethane (+6% to price list)

Certification Italienne contre le feu en classe 1IM avec revêtement PLANET ou BINGO ELAST/MIRAGE et polyuréthane ignifuge (+6% sur le tarif)





Ignifugo + extra 6% da listino prezzi

Fireproof + extra 6% to price list

Non feu + extra 6% sur le tarif

Redhot

- **Struttura telaio in metallo**
Metal frame structure
Structure en métal
- **Scocca in polipropilene**
Shell in polypropylene
Coque en polypropylène

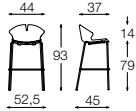
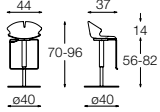
	Prezzo unitario € Unit price € Prix Unitaire €	 mc	 kg
<p>SGABELLO FISSO TELAIO 4 GAMBE CROMATO FIXED STOOL 4 LEGS CHROMED FRAME TABOURET FIXE PIETEMENT 4 PIEDS CHROME'</p> <p>RHG4_CR</p> 	191	0.31	12.95
<p>SGABELLO ELEVAZIONE A GAS CROMATO STOOL, GASLIFT CHROMED FRAME TABOURET ELEVATION GAZ CHROME'</p> <p>RHGG_CR</p> 	326	0.22	16.05

MINIMO ORDINE 2 PEZZI
MINIMUM ORDER 2 PCS
COMMANDE MINIMUM 2 PCS

SCocca DISPONIBILE NEI COLORI: ANTRACITE (AN), BIANCO (BC), GIALLO CEDRO (GI), AZZURRO (CE)
AVAILABLE COLORS: DARK GREY (AN), WHITE (BC), YELLOW (GI), SKY BLUE (CE)
COQUE DISPONIBLES DANS LE COLORIS: ANTHRACITE (AN), BLANC (BC), JAUNE (GI), BLUE CLAIR (CE)

Specificare il colore delle plastiche
Specify the color of the plastics
Spécifier le coloris des plastiques

Vanity

- **Imbottitura in schiumato a freddo**
Injected foam padding
Rembourrage en mousse moulée à froid
- **Struttura scocca in acciaio**
Shell in steel
Structure coque en acier

			Cat. F	Cat. G	Cat. S	Cat. TOP	Cat. EXTRA	Pelle Leather Cuir FIESTA	Pelle Leather Cuir NUVOLA	mc	kg
POLTRONCINA ARMCHAIR PETITE CHAISE											
VA4GCR	Telaio 4 gambe cromato Fixed 4 legs frame Piètement 4 pied chromé		529	537	572	592	623	644	732	0.33	12.5
VASLCR	Telaio slitta cromato Fixed sled frame Piètement traineau chromé		564	572	607	625	657	677	766	0.33	13.7
VATGCR	4 lame girevole in alluminio, meccanismo di ritorno 4 blades alu frame, swivel Return mechanism Piètement pivotant 4 branches aluminium, mécanisme retour		670	678	715	735	768	789	882	0.33	16.1
VAMGCR	Telaio tubolare girevole Tubular frame, swivel Piètement tubulaire chromé, pivotant		730	741	789	816	850	870	988	0.33	16.8
VAR_P	Telaio alluminio 4 razze piramidale nero (NR) o bianco (BC) su piedini Pyramidal 4 star aluminium frame black (NR) or white (BC) on glides Piètement en aluminium 4 branches pyramidale noir(NR) ou blanc(BC) sur patins		581	592	644	652	691	767	832	0.33	16.1
VARALP	Telaio alluminio 4 razze piramidale alluminio lucido su piedini Pyramidal 4 star polished aluminium frame on glides Piètement en aluminium poli 4 branches pyramidale sur patins		600	611	663	672	711	786	851	0.33	16.1
VAR_R	Telaio alluminio 4 razze piramidale nero (NR) o bianco (BC) su ruote Pyramidal 4 star aluminium frame black (NR) or white (BC) on castors Piètement en aluminium 4 branches pyramidale noir(NR) ou blanc(BC) sur roulettes		581	592	644	652	691	767	832	0.33	16.1
VARALR	Telaio alluminio 4 razze piramidale alluminio lucido su ruote Pyramidal 4 star polished aluminium frame on castors Piètement en aluminium poli 4 branches pyramidale sur roulettes		600	611	663	672	711	786	851	0.33	16.1
VAGPAL	Base alluminio 5 razze, elevazione gas Aluminium 5 star base, gaslift Piètement 5 branches aluminium		543	551	583	604	633	651	735	0.24	15.8

Consumi tessuto / Consumption fabric / Tissu nécessaire ml 1,70

Consumi pelle / Consumption leather / Cuir nécessaire mq 2,40



Omologazione ministeriale al fuoco in classe 11M con rivestimento PLANET o BINGO ELAST / MIRAGE e poliuretano ignifugo (+6% da listino)

Fireproof Italian Ministry homologation in 11M class with upholstery PLANET or BINGO ELAST / MIRAGE and fire retardant polyurethane (+6% to price list)
Certification Italienne contre le feu en classe 11M avec revêtement PLANET ou BINGO ELAST/MIRAGE et polyuréthane ignifuge (+6% sur le tarif)



Ignifugo + extra 6% da listino prezzi

Fireproof + extra 6% to price list
Non feu + extra 6% sur le tarif

“In equilibrio tra design e comfort oggi le aree lounge, le lobby degli hotel, le sale d’attesa, i meeting point, sono spazi soft e progettati seguendo il concetto di break out area, per accoglierci in relax fra un impegno e l’altro: che si tratti di lavoro, di vita sociale, a volte sono più confortevoli persino del nostro salotto di casa.”

Poltrone e divani

Armchairs and sofas / Fauteuils et canapes

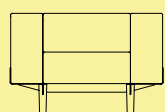

BREAD

102

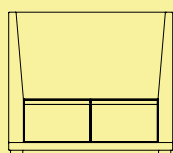

CIRCUIT

105

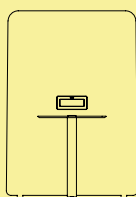

CIRCUIT
MEDIA

110

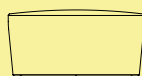

CIRCUIT
POUF

111

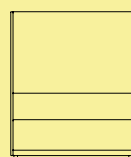

CIRCUIT
PRIVÈ

112



CROSS

113

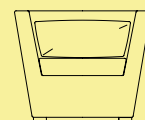

DOUBLE

114

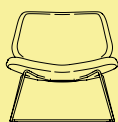

EON
LOUNGE

115

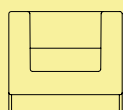

FRAME

116

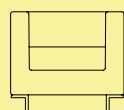

HALL

117

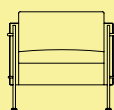

JAZZ

118

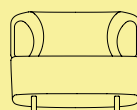

LOFT

119

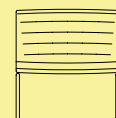

MISS
LOUNGE

120

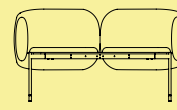

SNAKE

121

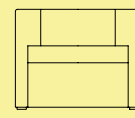

TOFFEE

126

“Delicately balancing design and comfort, today’s lounges and lobbies, waiting and meeting points, have become soft spaces, designed along the lines of breakout areas, to welcome us in relaxation between one commitment and another: whether for work or as part of our social life, sometimes they have even become more comfortable than our own living rooms.”

Bread

- **Struttura esterna in metallo verniciato bianco**
Metal structure frame in white color
Structure extérieure en métal peint en blanc
- **Imbottitura in poliuretano espanso**
Polyurethane foam padding
Rembourrage en mousse de polyuréthane
- **Struttura interna in legno**
Inner structure in wood
Structure en bois multiples
- **Piedini in rovere naturale**
Oak feet
Pieds en bois de chêne

			Cat. F	Cat. G	Cat. S	Cat. TOP	Cat. EXTRA	Pelle Leather Cuir FIESTA	Pelle Leather Cuir NUVOLA	mc	kg
ELEMENTI AUTO-PORTANTI SELF-STANDING ELEMENTS ELEMENTS AUTOPORTANT											
BRPC1P	Pouf Pouff Pouf		582	594	652	663	705	834	929	0.4	20.5
BRPC2P	Panca 2 posti 2-seater bench Banc 2 places		1.472	1.497	1.616	1.635	1.720	1.795	1.926	1.18	67
BRPC3P	Panca 3 posti 3-seater bench Banc 3 places		1.709	1.745	1.913	1.939	2.063	2.415	2.683	1.59	90
BRDV1	Poltrona Armchair Fauteuil		1.476	1.516	1.706	1.736	1.875	2.267	2.566	0.77	70
BRDV2	Divano 2 posti 2-seater sofa Canapé 2 places		2.011	2.066	2.332	2.373	2.568	3.116	3.536	1.18	83
BRDV3	Divano 3 posti 3-seater sofa Canapé 3 places		2.316	2.388	2.731	2.785	3.037	3.737	4.275	1.59	110
BRIS2D BRIS2S	Isola 2 posti 2-seater island sofa Ile 2 places		1.821	1.864	2.071	2.104	2.255	2.685	3.012	1.18	75
BRIS3D BRIS3S	Isola 3 posti 3-seater island sofa Ile 3 places		2.057	2.112	2.368	2.409	2.598	3.139	3.548	1.59	100

Consumi pouf tessuto / Pouf fabric consumption / Tissu nécessaire pouf **ml 1,60**

Consumi pouf pelle / Pouf leather consumption / Cuir nécessaire pouf **mq 2,70**

Consumi panca 2 posti tessuto / 2-seater bench fabric consumption / Tissu nécessaire banc 2 places **ml 3,20**

Consumi panca 2 posti pelle / 2-seater bench leather consumption / Cuir nécessaire banc 2 places **mq 5,00**

Consumi panca 3 posti tessuto / 3-seater bench fabric consumption / Tissu nécessaire banc 3 places **ml 4,50**

Consumi panca 3 posti pelle / 3-seater bench leather consumption / Cuir nécessaire banc 3 places **mq 7,80**

Consumi poltrona tessuto / Armchair fabric consumption / Tissu nécessaire fauteuil **ml 5,40**

Consumi poltrona pelle / Armchair leather consumption / Cuir nécessaire fauteuil **mq 8,50**

Consumi divano 2 posti tessuto / 2-seater sofa fabric consumption / Tissu nécessaire canapé 2 places **ml 7,50**

Consumi divano 2 posti pelle / 2-seater sofa leather consumption / Cuir nécessaire canapé 2 places **mq 12,00**

Consumi divano 3 posti tessuto / 3-seater sofa fabric consumption / Tissu nécessaire canapé 3 places **ml 9,50**

Consumi divano 3 posti pelle / 3-seater sofa leather consumption / Cuir nécessaire canapé 3 places **mq 15,00**

Consumi isola 2 posti tessuto / 2-seater island sofa fabric consumption / Tissu nécessaire ile 2 places **ml 5,60**

Consumi isola 2 posti pelle / 2-seater island sofa leather consumption / Cuir nécessaire ile 2 places **mq 9,50**

Consumi isola 3 posti tessuto / 3-seater island sofa fabric consumption / Tissu nécessaire ile 3 place **ml 7,30**

Consumi isola 2 posti pelle / 2-seater island sofa leather consumption / Cuir nécessaire ile 3 places **mq 11,50**

Omologazione ministeriale al fuoco in classe 1IM con rivestimento PLANET o BINGO ELAST / MIRAGE e poliuretano ignifugo (+6% da listino)

Fireproof Italian Ministry homologation in 1IM class with upholstery PLANET or BINGO ELAST / MIRAGE and fire retardant polyurethane (+6% to price list)

Certification Italienne contre le feu en classe 1IM avec revêtement PLANET ou BINGO ELAST/MIRAGE et polyuréthane ignifuge (+6% sur le tarif)



Ignifugo + extra 6% da listino prezzi

Fireproof + extra 6% to price list

Non feu + extra 6% sur le tarif

Bread

- **Struttura esterna in metallo verniciato bianco**
Metal structure frame in white color
Structure extérieure en métal peint en blanc
- **Imbottitura in poliuretano espanso**
Polyurethane foam padding
Rembourrage en mousse de polyuréthane
- **Struttura interna in legno**
Inner structure in wood
Structure en bois multiplis
- **Piedini in rovere naturale**
Oak feet
Pieds en bois de chêne

		Cat. F	Cat. G	Cat. S	Cat. TOP	Cat. EXTRA	Pelle Leather Cuir FIESTA	Pelle Leather Cuir NUVOLA	mc	kg
ELEMENTI PER COMPOSIZIONI NON AUTO-PORTANTI FOR COMPOSITIONS, NOT SELF-STANDING ELEMENTS POUR COMPOSITIONS, ELEMENTS NON AUTOPORTANT										
BRGI60SH	Elemento centrale 1p 60 cm con schienale Central element 1p 60 cm with back Element central 1p 60cm avec dossier		743	757	834	846	901	1.059	1.177	
BRGI60	Elemento centrale 1p 60 cm Central element 1p 60 cm Element central 1p 60cm		686	698	756	766	810	926	1.019	
BRGI90SH	Elemento centrale 1p 90 cm con schienale Central element 1p 90 cm with back Element central 1p 90cm avec dossier		893	918	1.035	1.053	1.141	1.388	1.575	
BRGI90	Elemento centrale 1p 90 cm Central element 1p 90 cm Element central 1p 90cm		823	841	925	939	1.001	1.195	1.335	
BRAN80C	Elemento angolo 80x80 con schienale Corner element 80x80 with backrest Element angle 80x80 avec dossier		987	999	1.058	1.067	1.111	1.228	1.320	
BRAN80	Elemento angolo 80x80 Corner element 80x80 Element angle 80x80		814	826	886	894	938	1.055	1.147	
BRELLT1D BRELLT1S	Elemento laterale 1p Side element 1p Element latérale 1p		1.087	1.115	1.250	1.271	1.369	1.644	1.856	
BRELLT2D BRELLT2S	Elemento laterale 2p Side element 2p Element latérale 2p		1.564	1.607	1.817	1.850	2.007	2.448	2.785	
BRELLT3D BRELLT3S	Elemento laterale 3p Side element 3p Element latérale 3p		1.861	1.921	2.213	2.259	2.472	3.074	3.531	
BRPN2D BRPN2S	Penisola 2p Side element 2p Péninsule 2p		1.401	1.436	1.596	1.620	1.739	2.065	2.316	
BRPN3D BRPN3S	Penisola 3p Side element 3p Péninsule 3p		1.656	1.694	1.880	1.908	2.044	2.387	2.665	



Omologazione ministeriale al fuoco in classe 1IM con rivestimento PLANET o BINGO ELAST / MIRAGE e poliuretano ignifugo (+6% da listino)

Fireproof Italian Ministry homologation in 1IM class with upholstery PLANET or BINGO ELAST / MIRAGE and fire retardant polyurethane (+6% to price list)

Certification Italienne contre le feu en classe 1IM avec revêtement PLANET ou BINGO ELAST/MIRAGE et polyuréthane ignifuge (+6% sur le tarif)



Ignifugo + extra 6% da listino prezzi

Fireproof + extra 6% to price list

Non feu + extra 6% sur le tarif

Bread

- **Struttura esterna in metallo verniciato bianco**
Metal structure frame in white color
Structure extérieure en métal peint en blanc
- **Imbottitura in poliuretano espanso**
Polyurethane foam padding
Rembourrage en mousse de polyuréthane
- **Struttura interna in legno**
Inner structure in wood
Structure en bois multiplis
- **Piedini in rovere naturale**
Oak feet
Pieds en bois de chêne

	Cat. F	Cat. G	Cat. S	Cat. TOP	Cat. EXTRA	Pelle Leather Cuir FIESTA	Pelle Leather Cuir NUVOLA	mc	kg
ELEMENTI PER COMPOSIZIONI NON AUTO-PORTANTI FOR COMPOSITIONS, NOT SELF-STANDING ELEMENTS POUR COMPOSITIONS, ELEMENTS NON AUTOPORTANT									
BRCL60D BRCL60S									
Chaise longue 60 cm con bracciolo Chaise longue 60 cm with arms Chaise longue 60 cm avec accoudoir									
	1.613	1.652	1.847	1.876	2.020	2.252	2.503		
BRCL90D BRCL90S									
Chaise longue 90 cm con bracciolo Chaise longue 90 cm with arms Chaise longue 90 cm avec accoudoir									
	1.857	1.903	2.121	2.157	2.317	2.750	3.088		
SQCU50									
Cuscino 50x50 Cushion 50x50 Coussin 50x50	128	133	154	165	185	193	253		

Consumi elemento centrale 60 cm tessuto / Central element 60 cm fabric consumption / Tissu nécessaire element central 60cm **ml 1,70**

Consumi elemento centrale 60 cm pelle / Central element 60 cm leather consumption / Cuir nécessaire element central 60 cm **mq 2,70**

Consumi elemento centrale 60 cm con schienale tessuto / Central element 60 cm with backrest fabric consumption / Tissu nécessaire element central 60cm avec dossier **ml 2,10**

Consumi elemento centrale 60 cm con schienale pelle / Central element 60 cm with backrest leather consumption / Cuir nécessaire element central 60cm avec dossier **mq 3,60**

Consumi elemento centrale 90 cm tessuto / Central element 90 cm fabric consumption / Tissu nécessaire element central 90 cm **ml 2,40**

Consumi elemento centrale 90 cm pelle / Central element 90 cm leather consumption / Cuir nécessaire element central 90 cm **mq 4,20**

Consumi elemento centrale 90 cm con schienale tessuto / Central element 90 cm with backrest fabric consumption / Tissu nécessaire element central 90cm **ml 3,20**

Consumi elemento centrale 90 cm con schienale pelle / Central element 90 cm with backrest leather consumption / Cuir nécessaire element central 90cm **mq 5,20**

Consumi elemento angolo tessuto / Corner element fabric consumption / Tissu nécessaire element angle **ml 1,70**

Consumi elemento angolo pelle / Corner element leather consumption / Cuir nécessaire element angle **mq 2,70**

Consumi elemento angolo con schienale tessuto / Corner element with backrest fabric consumption / Tissu nécessaire element angle avec dossier **ml 3,70**

Consumi elemento angolo con schienale pelle / Corner element with backrest leather consumption / Cuir nécessaire element angle avec dossier **mq 6,20**

Consumi elemento laterale 1p tessuto / 1p side element fabric consumption / Tissu nécessaire element lateral 1p **ml 3,80**

Consumi elemento laterale 1p pelle / 1p side element leather consumption / Cuir nécessaire element lateral 1p **mq 6,30**

Consumi elemento laterale 2p tessuto / 2p side element fabric consumption / Tissu nécessaire element lateral 2p **ml 5,70**

Consumi elemento laterale 2p pelle / 2p side element leather consumption / Cuir nécessaire element lateral 2places **mq 9,40**

Consumi elemento laterale 3p tessuto / 3p side element fabric consumption / Tissu nécessaire element lateral 3places **ml 7,50**

Consumi elemento laterale 3p pelle / 3p side element leather consumption / Cuir nécessaire element lateral 3place **mq 12,00**

Consumi penisola 2p tessuto / 2p peninsula fabric consumption / Tissu nécessaire peninsule 2 places **ml 4,30**

Consumi penisola 2p pelle / 2p peninsula leather consumption / Cuir nécessaire peninsule 2 places **mq 7,30**

Consumi penisola 3p tessuto / 3p peninsula fabric consumption / Tissu nécessaire peninsule 3p **ml 5,00**

Consumi penisola 3p pelle / 3p peninsula leather consumption / Cuir nécessaire peninsule 3p **mq 8,00**

Consumi chaise longue 60 cm tessuto / Chaise longue 60 cm fabric consumption / Tissu nécessaire chaise longue 60 cm **ml 5,30**

Consumi chaise longue 60 cm pelle / Chaise longue 60 cm consumption / Cuir nécessaire chaise longue 60 cm **mq 8,50**

Consumi chaise longue 90 cm tessuto / Chaise longue 90 cm fabric consumption / Tissu nécessaire chaise longue 90cm **ml 6,00**

Consumi chaise longue 90 cm pelle / Chaise longue 90 cm consumption / Cuir nécessaire chaise longue 90 cm **mq 9,80**



Omologazione ministeriale al fuoco in classe 1IM con rivestimento PLANET o BINGO ELAST / MIRAGE e poliuretano ignifugo (+6% da listino)

Fireproof Italian Ministry homologation in 1IM class with upholstery PLANET or BINGO ELAST / MIRAGE and fire retardant polyurethane (+6% to price list)

Certification Italienne contre le feu en classe 1IM avec revêtement PLANET ou BINGO ELAST/MIRAGE et polyuréthane ignifuge (+6% sur le tarif)



Ignifugo + extra 6% da listino prezzi

Fireproof + extra 6% to price list

Non feu + extra 6% sur le tarif

Circuit

- **Imbottitura in poliuretano espanso**
Polyurethane foam padding
Rembourrage en mousse de polyuréthane
- **Struttura in legno**
Inner structure in wood
Structure en bois multiples
- **Piedini in legno verniciato antracite**
Dark grey varnished wooden feet
Pieds en bois peint anthracite

			Cat. F	Cat. G	Cat. S	Cat. TOP	Cat. EXTRA	Pelle Leather Cuir FIESTA	Pelle Leather Cuir NUVOLA	mc	kg
Idee composizioni Ideas for compositions Idées pour compositions											
Mod. 1	Schienale 55, 1 base 79, 2 braccioli anello Back 55, 1 base 79, 2 open arms Dossier 55, 1 assise 79, 2 accoudoirs ouvertes		1.325	1.360	1.536	1.565	1.695	-	-	0.47	40
Mod. 2	Schienale 134, 2 basi 79, 2 braccioli anello Back 134, 2 bases 79, 2 open arms Dossier 134, 2 assises 79, 2 accoudoirs ouvertes		1.636	1.755	2.037	2.081	2.286	-	-	0.97	56.2
Mod. 3	Schienale 79, 1 base 55, 2 braccioli chiusi Back 79, 1 base 55, 2 closed arms Dossier 79, 1 assise 55, 2 accoudoirs fermés		1.033	1.076	1.278	1.309	1.457	-	-	0.47	40
Mod. 4	Schienale 134, 2 basi 55, 2 braccioli chiusi Back 134, 2 bases 55, 2 closed arms Dossier 134, 2 assises 55, 2 accoudoirs fermés		1.292	1.339	1.551	1.587	1.831	-	-	0.93	66
Mod. 5	Schienale 134, 2 basi 67 Back 134, 2 bases 67 Dossier 134, 2 assises 67		995	1.029	1.202	1.227	1.352	-	-	0.93	55
Mod. 6	Schienale 134, 2 basi 134, 2 braccioli anello, 2 piedi Back 134, 2 bases 134, 2 open arms, 2 metal feet Dossier 134, 2 assises 134, 2 accoudoirs ouvertes, 2 pieds métal		2.077	2.141	2.453	2.504	2.735	-	-	2.79	75
Mod. 7	Schienale alto 134, 2 basi 67 High back 134, 2 bases 67 Dossier haut 134, 2 assises 67		1.068	1.112	1.327	1.359	1.516	-	-	1.42	53.3
Mod. 8	1 base 134, 2 piedi 1 base 134, 2 metal feet 1 assise 134, 2 pieds métal		521	536	608	619	673	-	-	0.45	13.6
Mod. 9	Schienale 134, 2 braccioli alti, 2 basi 55 Back 134, 2 side high arms, 2 bases 55 Dossier 134, 2 accoudoirs haut, 2 assise 55		1.532	1.610	1.962	2.021	2.280	-	-	1.42	59.3
Mod. 10	Schienale 30°, Base 30° Back 30°, Base 30° Dossier 30°, assise 30°		718	743	867	887	978	-	-	0.47	26.5







Circuit

- **Imbottitura in poliuretano espanso**
Polyurethane foam padding
Rembourrage en mousse de polyuréthane
- **Struttura in legno**
Inner structure in wood
Structure en bois multiplis
- **Piedini in legno verniciato antracite**
Dark grey varnished wooden feet
Pieds en bois peint anthracite

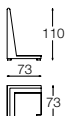
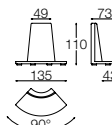
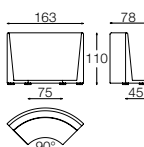
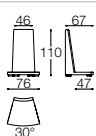
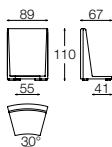
			Cat. F	Cat. G	Cat. S	Cat. TOP	Cat. EXTRA	Pelle Leather Cuir FIESTA	Pelle Leather Cuir NUVOLA	mc	kg
Componente schienale Back component Element dossier											
CISHB550	Schienale basso L 55 H 73 Backrest L 55 Dossier bas L 55 H 73		435	443	477	482	507	-	-		
CISHB790	Schienale basso L 79 H 73 Backrest L 79 Dossier bas L 79 H 73		496	509	578	590	640	-	-		
CISHB1340	Schienale basso L 134 H 73 Backrest L 134 Dossier bas L 134 H 73		561	577	659	672	730	-	-		
CISHAN90	Schienale 90° angolo basso H 73 90° corner backrest Dossier angle 90° bas H 73		561	577	659	672	730	-	-		
CISHAN270	Schienale 270° angolo basso H 73 270° corner backrest Dossier angle 270° bas H 73		545	561	637	648	704	-	-		
CISHAV030	Schienale angolo curvo 30° basso concavo Concave backrest 30° Dossier angle courbe 30° bas concave		484	498	567	578	628	-	-		
CISHAS030	Schienale angolo curvo 30° basso convesso Convex backrest 30° Dossier angle courbe 30° bas convexe		484	498	567	578	628	-	-		
CISHANR90	Schienale angolo curvo 90° basso convesso BACKREST curve shape 90° low convex Dossier angle courbe 90° bas convexe		560	575	648	658	712	-	-		
CISHANC90	Schienale angolo curvo 90° basso concavo BACKREST curve shape 90° low concave Dossier angle courbe 90° bas concave		594	609	680	691	744	-	-		
CISHA790	Schienale alto L 79 H 110 High backrest L 79 H 110 Dossier haut L 79 H 110		561	579	669	682	749	-	-		
CISHA1340	Schienale alto L 134 H 110 High backrest L 134 H 110 Dossier haut L 134 H 110		633	661	784	804	895	-	-		

Circuit

- **Imbottitura in poliuretano espanso**
Polyurethane foam padding
Rembourrage en mousse de polyuréthane
- **Struttura in legno**
Inner structure in wood
Structure en bois multiplis
- **Piedini in legno verniciato antracite**
Dark grey varnished wooden feet
Pieds en bois peint anthracite

		Cat. F	Cat. G	Cat. S	Cat. TOP	Cat. EXTRA	Pelle Leather Cuir FIESTA	Pelle Leather Cuir NUVOLA	mc	kg
Componente schienale Back component Element dossier										
CISHANA90	Schienale 90° angolo alto H 110 90° corner backrest H 110 Dossier angle 90° haut H 110									
		721	754	896	918	1.023	-	-		
CISHANAR90	Schienale angolo curvo 90° alto convesso BACKREST curve shape 90° HIGH convex Dossier angle courbe 90° haut convexe									
		822	872	1.116	1.155	1.336	-	-		
CISHANAC90	Schienale angolo curvo 90° alto concavo BACKREST curve shape 90° HIGH concave Dossier angle courbe 90° haut concave									
		863	916	1.172	1.212	1.402	-	-		
CISHASA30	Schienale angolo curvo 30° alto convesso BACKREST curve shape 30° HIGH convex Dossier angle courbe 30° haut convexe									
		548	568	658	674	741	-	-		
CISHAVA30	Schienale angolo curvo 30° alto concavo BACKREST curve shape 30° HIGH concave Dossier angle courbe 30° haut concave									
		609	631	732	749	823	-	-		
Componente sedile Seat component Element assise										
CISD490	Base L 49 Base L 49 Assise L 49									
		177	188	232	239	272	-	-		
CISD550	Base L 55 Base L 55 Assise L 55									
		188	198	243	250	283	-	-		
CISD610	Base L 61 Base L 61 Assise L 61									
		204	212	258	263	297	-	-		
CISD670	Base L 67 Base L 67 Assise L 67									
		218	226	271	278	310	-	-		
CISD790	Base L 79 Base L 79 Assise L 79									
		250	261	317	325	367	-	-		
CISD1100	Base L 110 Base L 110 Assise L 110									
		330	345	417	428	482	-	-		



Circuit

- **Imbottitura in poliuretano espanso**
Polyurethane foam padding
Rembourrage en mousse de polyuréthane
- **Struttura in legno**
Inner structure in wood
Structure en bois multiplis
- **Piedini in legno verniciato antracite**
Dark grey varnished wooden feet
Pieds en bois peint anthracite

			Cat. F	Cat. G	Cat. S	Cat. TOP	Cat. EXTRA	Pelle Leather Cuir FIESTA	Pelle Leather Cuir NUVOLA	mc	kg
Componente sedile Seat component Element assise											
CISD1220	Base L 122 Base L 122 Assise L 122		343	358	430	442	496	-	-		
CISD1340	Base L 134 Base L 134 Assise L 134		357	372	444	456	509	-	-		
CISDASO30	Base curva 30° Seat base 30° Assise 30° courbe		234	245	300	309	349	-	-		
CISDAN90	Base 90° angolo 90° corner base Assise 90° angle		250	261	317	325	367	-	-		
CISDAN270	Base 270° angolo 270° corner base Assise 270° angle		250	261	317	325	367	-	-		
CISDANR90	Base angolo curvo 90° 90° curve shape base Assise 90° angle courbe		491	515	627	646	727	-	-		
Accessori / Accessories / Accessoires											
CIBRAN	Bracciolo anello Open armrest Accoudoir ouverte		319	329	371	379	410	-	-		
CIBRST	Bracciolo chiuso Closed armrest Accoudoir fermé		174	184	229	235	268	-	-		
CIACAC	Bracciolo alto centrale High central armrest Accoudoir haut central		261	276	347	358	410	-	-		
CIACAL	Bracciolo alto laterale High side armrest Accoudoir haut latéral		261	276	347	358	410	-	-		
CIBREL UK	Bracciolo anello elettrificato UK Open armrest British electrification Accoudoir ouverte avec électrification UK		1.054	1.061	1.100	1.107	1.137	-	-		

Circuit

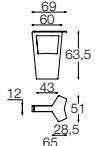
- **Imbottitura in poliuretano espanso**
Polyurethane foam padding
Rembourrage en mousse de polyuréthane
- **Struttura in legno**
Inner structure in wood
Structure en bois multiplis
- **Piedini in legno verniciato antracite**
Dark grey varnished wooden feet
Pieds en bois peint anthracite

Accessori / Accessories / Accessoires		Cat. F	Cat. G	Cat. S	Cat. TOP	Cat. EXTRA	Pelle Leather Cuir FIESTA	Pelle Leather Cuir NUVOLA	
CIBREL IT	Bracciolo anello elettrificato ITALIA Open armrest Italian electrification Accoudoir ouverte avec électrification ITALIA		803	812	851	857	886	-	-
CIACPO	POUF POUFF POUF		247	256	299	306	337	-	-

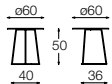
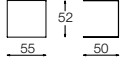
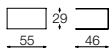
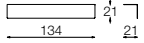
Accessori / Accessories / Accessoires		Prezzo unitario € Unit price € Prix Unitaire €	
CIBAPP	Piede metallo antracite per panca Bench foot in anthracite finish Pied métal anthracite pour banc		76
CI600	Tavolino tondo diam. 60 cm Bianco (BI) o Nero (NR) Round shape diam. 60 cm table White (BI) or Black (NR) Table ronde diam. 60 cm Blanc (BI) ou Noir (NR)		272
CITVALBC	Tavolino laterale in lamiera bianca alto Side high metal table white lacquered Table latéral en tôle blanc haut		226
CITVBLBC	Tavolino laterale in lamiera bianca basso Side low metal table white lacquered Table latéral en tôle blanc bas		213
CITPPLBC	Piano appoggio posteriore in lamiera bianca Back support table white lacquered Tableau posterieur en tôle blanc		365



Omologazione ministeriale al fuoco in classe 1IM con rivestimento PLANET o BINGO ELAST / MIRAGE e poliuretano ignifugo (+6% da listino)
Fireproof Italian Ministry homologation in 1IM class with upholstery PLANET or BINGO ELAST / MIRAGE and fire retardant polyurethane (+6% to price list)
Certification Italienne contre le feu en classe 1IM avec revêtement PLANET ou BINGO ELAST/MIRAGE et polyuréthane ignifuge (+6% sur le tarif)



Ignifugo + extra 6% da listino prezzi
Fireproof + extra 6% to price list
Non feu + extra 6% sur le tarif

Circuit Media

- **Imbottitura poliuretano espanso**
Polyurethane foam padding
Rembourrage en mousse de polyuréthane
- **Struttura in legno**
Inner structure in wood

	Cat. F	Cat. G	Cat. S	Cat. TOP	Cat. EXTRA	Pelle Leather Cuir FIESTA	Pelle Leather Cuir NUVOLA	mc	kg
ELEMENTO CON PIANO HPL E PRESE USB A SCOMPARSA ELEMENT WITH TOP IN HPL AND USB PORTS ÉLÉMENT AVEC TOP EN HPL ET PRISES USB									
CIMP160 Piedi in rovere naturale fissi Fixed natural oak feet Pieds fixes en chêne naturel									
CIMP160RU Con ruote With castors Avec roulettes									
Accessori / Accessories / Accessoires					Prezzo unitario € Unit price € Prix Unitaire €				
CIMPWEU Presa da fissare a parete con 2 SCHUKO e 2 USB Socket to fix in the wall panel, with 2 SCHUKO and 2 USB ports Prise à fixer au panneau avec 2 SCHUKO et 2 USB									

AVAILABLE BS 1363 PLUG/SOCKET PLEASE SPECIFY IT IN THE ORDER PRICE DOESN'T CHANGE

US or OTHER THAN ITALIAN SOKETS AVAILABLE - PRICE ON DEMAND - PLEASE CONTACT DIEMME
PRISES POUR AUTRES PAIS DISPONIBLES - PRIX SUR DEMANDE - CONTACTER AVEC L'USINE DIEMME

Consumi tessuto / Fabric consumption / Tissu nécessaire ml 4,50









Omologazione ministeriale al fuoco in classe 1IM con rivestimento PLANET o BINGO ELAST / MIRAGE e poliuretano ignifugo (+6% da listino)
Fireproof Italian Ministry homologation in 1IM class with upholstery PLANET or BINGO ELAST / MIRAGE and fire retardant polyurethane (+6% to price list)
Certification Italienne contre le feu en classe 1IM avec revêtement PLANET ou BINGO ELAST/MIRAGE et polyuréthane ignifuge (+6% sur le tarif)



Ignifugo + extra 6% da listino prezzi
Fireproof + extra 6% to price list
Non feu + extra 6% sur le tarif

Circuit Pouf

- **Imbottitura in poliuretano espanso**
Polyurethane foam padding
Rembourrage en mousse de polyuréthane
- **Struttura in legno**
Inner structure in wood
Structure en bois multiples
- **Piedini in polietilene nero**
Black polyethylene feet
Pieds en polyéthylène noir

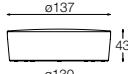
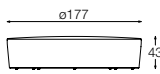
	Cat. F	Cat. G	Cat. S	Cat. TOP	Cat. EXTRA	Pelle Leather Cuir FIESTA	Pelle Leather Cuir NUVOLA	 mc	 kg
Pouf Ottomans Pouf									
CIP055H32 	281	292	329	335	389	437	486	0.17	6
CIP055H43 	313	324	362	373	410	464	518	0.21	6
CIP087H43 	513	524	594	605	691	740	815	0.4	15
CIP096H32 	551	567	659	675	788	864	972	0.3	16
CIP137H43 	891	913	1.048	1.069	1.231	1.339	1.496	0.9	40
CIP177H43 	1.285	1.328	1.534	1.566	1.825	1.987	2.236	1.3	60

Consumi diam. 55 cm tessuto / Diam. 55 cm fabric consumption / Diam. 55 cm tissu nécessaire **ml 1,50**
Consumi diam. 55 cm pelle / Diam. 55 cm leather consumption / Diam. 55 cm cuir nécessaire **mq 2,00**

Consumi diam. 87 cm tessuto / Diam. 87 cm fabric consumption / Diam. 87 cm tissu nécessaire **ml 2,20**
Consumi diam. 87 cm pelle / Diam. 87 cm leather consumption / Diam. 87 cm cuir nécessaire **mq 3,00**

Consumi diam. 96 cm tessuto / Diam. 96 cm fabric consumption / Diam. 96 cm tissu nécessaire **ml 2,80**
Consumi diam. 96 cm pelle / Diam. 96 cm leather consumption / Diam. 96 cm cuir nécessaire **mq 4,00**

Consumi diam. 137 cm tessuto / Diam. 137 cm fabric consumption / Diam. 137 cm tissu nécessaire **ml 4,00**
Consumi diam. 137 cm pelle / Diam. 137 cm leather consumption / Diam. 137 cm cuir nécessaire **mq 5,50**

Consumi diam. 177 cm tessuto / Diam. 177 cm fabric consumption / Diam. 177 cm tissu nécessaire **ml 6,00**
Consumi diam. 177 cm pelle / Diam. 177 cm leather consumption / Diam. 177 cm cuir nécessaire **mq 8,00**



Omologazione ministeriale al fuoco in classe 1IM con rivestimento PLANET o BINGO ELAST / MIRAGE e poliuretano ignifugo (+6% da listino)
Fireproof Italian Ministry homologation in 1IM class with upholstery PLANET or BINGO ELAST / MIRAGE and fire retardant polyurethane (+6% to price list)
Certification Italienne contre le feu en classe 1IM avec revêtement PLANET ou BINGO ELAST/MIRAGE et polyuréthane ignifuge (+6% sur le tarif)



Ignifugo + extra 6% da listino prezzi
Fireproof + extra 6% to price list
Non feu + extra 6% sur le tarif

Circuit Privé

- **Imbottitura poliuretano espanso**
Polyurethane foam padding
Rembourrage en mousse de polyuréthane
- **Struttura in legno**
Inner structure in wood
- **Piedi in rovere naturale**
Oak feet
Pieds en bois de chêne

			Cat. F	Cat. G	Cat. S	Cat. TOP	Cat. EXTRA	Pelle Leather Cuir FIESTA	Pelle Leather Cuir NUVOLA	mc	kg
Box con tetto e braccioli laterali, piedi in rovere naturale Booth with top cover and side arms, with real oak feet Cabine avec toit et accoudoirs avec pieds en chêne naturel											
CISP1340 CISD1340	Seduta intera da 134 cm Only seat of 134 cm Assise entière de 134 cm		1.873	1.958	2.368	2.432	2.734	-	-	2.33	80
CISP1340 CISD670 X 2	2 sedute da 67 cm 2 seats of 67 cm 2 assises de 67 cm		1.950	2.037	2.465	2.532	2.844	-	-	2.33	80
CISP1340 CISD790 CITVALBC	1 seduta da 79 cm e un tavolino 1 seat of 79 cm and 1 table 1 assise de 79 cm et 1 table		1.990	2.072	2.465	2.527	2.817	-	-	2.33	80
CISP790 CISD790	1 seduta da 79 cm 1 seat of 79 cm 1 assise de 79 cm		1.463	1.531	1.856	1.907	2.148	-	-	1.36	70

Consumo tessuto 2 posti solo struttura / 2-seater fabric consumption only structure / Tissu nécessaire 2 places seule structure **ml 10,00**

Consumo tessuto 1 posto solo struttura / Single seater fabric consumption only structure / Tissu nécessaire 1 place seule structure **ml 8,00**

Consumo tessuto base 134 / Fabric consumption seat base 134 / Tissu nécessaire assise 134 **ml 2,20**

Consumo tessuto base 79 / Fabric consumption seat base 79 / Tissu nécessaire assise 79 **ml 1,60**

Consumo tessuto base 67 / Fabric consumption seat base 67 / Tissu nécessaire assise 67 **ml 1,60**



Omologazione ministeriale al fuoco in classe 11M con rivestimento PLANET o BINGO ELAST / MIRAGE e poliuretano ignifugo (+6% da listino)

Fireproof Italian Ministry homologation in 11M class with upholstery PLANET or BINGO ELAST / MIRAGE and fire retardant polyurethane (+6% to price list)

Certification Italienne contre le feu en classe 11M avec revêtement PLANET ou BINGO ELAST/MIRAGE et polyuréthane ignifuge (+6% sur le tarif)



Ignifugo + extra 6% da listino prezzi

Fireproof + extra 6% to price list

Non feu + extra 6% sur le tarif

Cross

EN 1728

- **Imbottitura in poliuretano espanso**
High density polyurethane foam padding
Rembourrage en mousse de polyuréthane
- **Struttura in legno**
Inner structure in wood
Structure en bois multiplis
- **Piedini in polipropilene nero**
Black polypropylene feet
Pieds en polypropylène noir

			Cat. F	Cat. G	Cat. S	Cat. TOP	Cat. EXTRA	Pelle Leather Cuir FIESTA	Pelle Leather Cuir NUVOLA	mc	kg
CRBPF	Pouf Pouf Pouf		540	567	630	654	708	793	955	0.4	18.5
CRSPF	Pouf con schienale Pouf and backrest Pouf avec dossier		751	789	878	917	994	1.124	1.362	0.69	27
CRADV	Divano con schienale Sofa with backrest Canapé avec dossier		1.158	1.218	1.361	1.421	1.543	1.746	2.155	1.23	52
CRBDV	Divano con schienale Sofa with backrest Canapé avec dossier		1.158	1.218	1.361	1.421	1.543	1.746	2.155	1.23	52

Consumi pouf tessuto / POUF fabric consumption / Tissu nécessaire pouf **ml 2,40**

Consumi poltrona pelle / Armchair leather consumption / Cuir nécessaire fauteuil **mq 3,90**

Consumi pouf con schienale tessuto / Pouf w/backrest fabric consumption / Tissu nécessaire pouf avec dossier **ml 3,40**

Consumi pouf con schienale pelle / Pouf w/backrest leather consumption / Cuir nécessaire pouf avec dossier **mq 5,70**

Consumi divano con schienale tessuto / Sofa w/backrest fabric consumption / Tissu nécessaire canapé avec dossier **ml 5,30**

Consumi divano con schienale pelle / Sofa w/backrest leather consumption / Cuir nécessaire canapé avec dossier **mq 8,80**

Consumi dettagliati tessuto / Consumption detailed fabric / Tissu nécessaire

A=0,25 ml B=1,00 ml C=1,00 ml D=1,35 ml E=0,60 ml F=1,90 ml G=1,30 ml H=2,20 ml I=1,00 ml L=1,35 ml

Consumi dettagliati pelle / Consumption detailed leather / Cuir nécessaire

A=0,50 ml B=1,50 ml C=1,50 ml D=2,00 ml E=1,00 ml F=2,70 ml G=2,00 ml H=3,20 ml I=1,40 ml L=1,90 ml

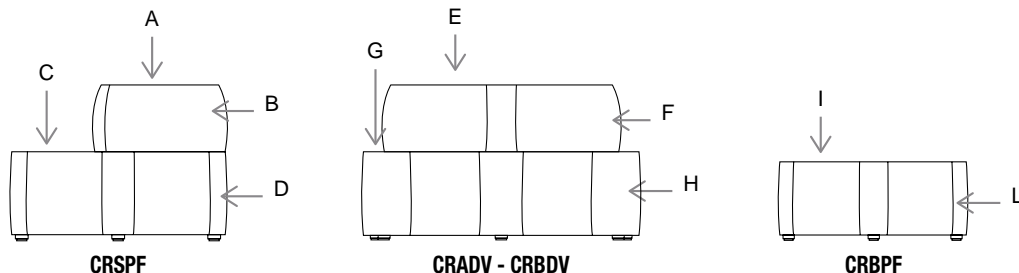

Omologazione ministeriale al fuoco in classe 1IM con rivestimento PLANET o BINGO ELAST / MIRAGE e poliuretano ignifugo (+6% da listino)

Fireproof Italian Ministry homologation in 1IM class with upholstery PLANET or BINGO ELAST / MIRAGE and fire retardant polyurethane (+6% to price list)

Certification Italienne contre le feu en classe 1IM avec revêtement PLANET ou BINGO ELAST/MIRAGE et polyuréthane ignifuge (+6% sur le tarif)





Ignifugo + extra 6% da listino prezzi

Fireproof + extra 6% to price list

Non feu + extra 6% sur le tarif

Double

- **Imbottitura in poliuretano espanso**
Polyurethane foam padding
Rembourrage en mousse de polyuréthane
- **Struttura in legno**
Inner structure in wood
Structure en bois multiples
- **Piedini in alluminio lucido**
Aluminium feet
Pieds en aluminium poli

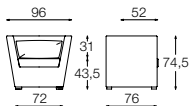
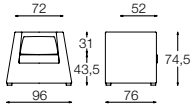
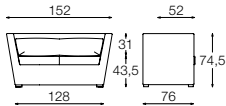
			Cat. F	Cat. G	Cat. S	Cat. TOP	Cat. EXTRA	Pelle Leather Cuir FIESTA	Pelle Leather Cuir NUVOLA	 mc	 kg
POLTRONE ARMCHAIRS FAUTEUIL											
DOUA1P	Poltrona aperta Open armchair Fauteuil ouverte		997	1.037	1.211	1.297	1.435	1.602	2.126	0.69	32
DOUB1P	Poltrona chiusa Closed armchair Fauteuil fermé		966	999	1.144	1.220	1.345	1.527	2.022	0.69	32
DIVANETTO 2 POSTI 2 SEATER SOFA CANAPÉ 2 PLACES											
DOUA2P	Divano 2 posti 2-seater sofa Canapé 2 places		1.330	1.380	1.587	1.700	1.878	2.003	2.566	1.2	53

Consumi poltrona aperta tessuto / Open armchair fabric consumption / Tissu nécessaire fauteuil ouverte **ml 5,00**

Consumi poltrona aperta pelle / Open armchair leather consumption / Cuir nécessaire fauteuil ouverte **mq 9,00**

Consumi poltrona chiusa tessuto / Closed armchair fabric consumption / Tissu nécessaire fauteuil fermé **ml 4,50**

Consumi poltrona chiusa pelle / Closed armchair leather consumption / Cuir nécessaire fauteuil fermée **mq 8,50**

Consumi divano 2 posti tessuto / 2-seater sofa fabric consumption / Tissu nécessaire canapé avec dossier **ml 7,50**

Consumi divano 2 posti pelle / 2-seater sofa leather consumption / Cuir nécessaire canapé 2 places **mq 12,00**



Omologazione ministeriale al fuoco in classe 11M con rivestimento PLANET o BINGO ELAST / MIRAGE e poliuretano ignifugo (+6% da listino)

Fireproof Italian Ministry homologation in 11M class with upholstery PLANET or BINGO ELAST / MIRAGE and fire retardant polyurethane (+6% to price list)

Certification Italienne contre le feu en classe 11M avec revêtement PLANET ou BINGO ELAST/MIRAGE et polyuréthane ignifuge (+6% sur le tarif)



Ignifugo + extra 6% da listino prezzi

Fireproof + extra 6% to price list

Non feu + extra 6% sur le tarif

Eon Lounge

- **Imbottitura in poliuretano espanso**
Polyurethane foam padding
Rembourrage en mousse de polyuréthane
- **Scocca in legno**
Shell in wood
Coque en bois

	Cat. F	Cat. G	Cat. S	Cat. TOP	Cat. EXTRA	Pelle Leather Cuir FIESTA	Pelle Leather Cuir NUVOLA	mc	kg
POLTRONA ARMCHAIR FAUTEUIL									
EOLPLCNR									
Telaio slitta nero Black lacquered sled frame Structure traîneau laqué noir									
	725	736	799	810	855	986	1.071	0.56	17.6
EOLPL4NR									
Telaio alluminio nero 4 razze girevole Black aluminum frame, swivel Structure 4 rayons en aluminium laqué noir									
	725	736	799	810	855	986	1.071	0.56	18.4
DIVANETTO 2 POSTI 2 SEATER SOFA CANAPE 2 PLACES									
EOLDVCNR									
Telaio slitta nero Black lacquered sled frame Structure traîneau laqué noir									
	929	952	1.042	1.059	1.127	1.252	1.365	0.93	28.7
POUF POUF POUF									
EOLPP4NR									
Telaio 4 razze alluminio nero girevole Black aluminum frame, swivel Structure 4 rayons en aluminium laqué noir									
	516	521	561	567	595	668	719	0.24	7.25

Consumi poltrona tessuto / Armchair fabric consumption / Tissu nécessaire fauteuil **ml 1,60**

Consumi poltrona pelle / Armchair leather consumption / Cuir nécessaire fauteuil **mq 2,80**

Consumi divano 2 posti tessuto / 2-seater sofa fabric consumption / Tissu nécessaire canapé 2 places **ml 2,50**

Consumi divano 2 posti pelle / 2-seater sofa leather consumption / Cuir nécessaire canapé 2 places **mq 3,50**

Consumi POUF tessuto / POUF fabric consumption / Tissu nécessaire pouf **ml 1,00**

Consumi POUF pelle / POUF leather consumption / Cuir nécessaire pouf **mq 1,70**



Omologazione ministeriale al fuoco in classe 1IM con rivestimento PLANET o BINGO ELAST / MIRAGE e poliuretano ignifugo (+6% da listino)

Fireproof Italian Ministry homologation in 1IM class with upholstery PLANET or BINGO ELAST / MIRAGE and fire retardant polyurethane (+6% to price list)

Certification ministérielle contre le feu en classe 1IM avec revêtement PLANET ou BINGO ELAST / MIRAGE et polyuréthane ignifuge (+ 6% à partir de la liste de prix)





Ignifugo + extra 6% da listino prezzi

Fireproof + extra 6% to price list

Non feu + extra 6% sur le tarif

Frame

- **Imbottitura in poliuretano espanso**
Polyurethane foam padding
Rembourrage en mousse de polyuréthane
- **Struttura in legno**
Inner structure in wood
Structure en bois multiplis
- **Piedini in alluminio lucido**
Polished aluminium feet
Pieds en aluminium poli

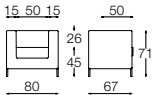
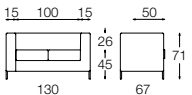
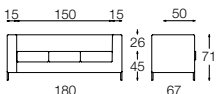
			Cat. F	Cat. G	Cat. S	Cat. TOP	Cat. EXTRA	Pelle Leather Cuir FIESTA	Pelle Leather Cuir NUVOLA	 mc	 kg
FRPL	Poltrona Armchair Fauteuil		775	802	916	975	1.074	1.149	1.622	0.46	27.5
FRD2	Divano 2 posti 2-seater sofa Canapé 2 places		1.113	1.149	1.304	1.385	1.517	1.763	2.177	0.91	38
FRD3	Divano 3 posti 3-seater sofa Canapé 3 places		1.368	1.416	1.614	1.723	1.893	2.211	2.751	1.19	54

Consumi poltrona tessuto / Armchair fabric consumption / Tissu nécessaire fauteuil **ml 4,20**

Consumi poltrona pelle / Armchair leather consumption / Cuir nécessaire fauteuil **mq 6,00**

Consumi divano 2 posti tessuto / 2-seater sofa fabric consumption / Tissu nécessaire canapé 2 places **ml 5,50**

Consumi divano 2 posti pelle / 2-seater sofa leather consumption / Cuir nécessaire canapé 2 places **mq 7,50**

Consumi divano 3 posti tessuto / 3-seater sofa fabric consumption / Tissu nécessaire canapé 3 places **ml 7,00**

Consumi divano 3 posti pelle / 3-seater sofa leather consumption / Cuir nécessaire canapé 3 places **mq 9,60**



Omologazione ministeriale al fuoco in classe 1IM con rivestimento PLANET o BINGO ELAST / MIRAGE e poliuretano ignifugo (+6% da listino)

Fireproof Italian Ministry homologation in 1IM class with upholstery PLANET or BINGO ELAST / MIRAGE and fire retardant polyurethane (+6% to price list)

Certification Italienne contre le feu en classe 1IM avec revêtement PLANET ou BINGO ELAST/MIRAGE et polyuréthane ignifuge (+6% sur le tarif)





Ignifugo + extra 6% da listino prezzi

Fireproof + extra 6% to price list

Non feu + extra 6% sur le tarif

Hall

- **Telaio in metallo verniciato antracite**
Dark grey lacquered metal frame
Structure en métal peint anthracite
- **Imbottitura in poliuretano espanso**
Polyurethane foam padding
Rembourrage en mousse de polyuréthane
- **Struttura in legno**
Inner structure in wood
Structure en bois multiplis

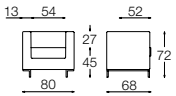
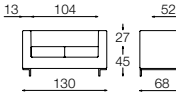
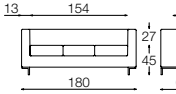
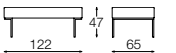
			Cat. F	Cat. G	Cat. S	Cat. TOP	Cat. EXTRA	Pelle Leather Cuir FIESTA	Pelle Leather Cuir NUVOLA	 mc	 kg
HADV1	Poltrona Armchair Fauteuil		707	728	828	842	915	1.176	1.336	0.46	24
HADV2	Divano 2 posti 2-seater sofa Canapé 2 places		1.015	1.049	1.211	1.237	1.356	1.704	1.944	0.91	35
HADV3	Divano 3 posti 3-seater sofa Canapé 3 places		1.323	1.371	1.598	1.633	1.800	2.359	2.714	1.19	46
HAPN2	Panca 2 posti 2-seater bench Banc 2 places		550	563	630	641	689	771	852	0.55	27.5

OPTIONAL: CUCITURA A ROMBI: POLTRONA € 80 / 2 POSTI € 100 / 3 POSTI € 120
 OPTIONAL: STITCHING IN THE BACK: ARMCHAIR € 80 / 2-SEATER € 100 / 3-SEATER € 120
 OPTIONAL: COULTURES LOSANGE FAUTEUIL € 80 / CANAPE 2 PLACES € 100 / CANAPE 3 PLACES €

Consumi poltrona tessuto / Armchair fabric consumption / Tissu nécessaire fauteuil **ml 4,20**
Consumi poltrona pelle / Armchair leather consumption / Cuir nécessaire fauteuil **mq 6,00**

Consumi divano 2 posti tessuto / 2-seater sofa fabric consumption / Tissu nécessaire canapé 2 places **ml 5,50**
Consumi divano 2 posti pelle / 2-seater sofa leather consumption / Cuir nécessaire canapé 2 places **mq 7,50**

Consumi divano 3 posti tessuto / 3-seater sofa fabric consumption / Tissu nécessaire canapé 3 places **ml 7,00**
Consumi divano 3 posti pelle / 3-seater sofa leather consumption / Cuir nécessaire canapé 3 places **mq 9,60**

Consumi panca 2 posti tessuto / 2-seater bench fabric consumption / Tissu nécessaire banc 2 places **ml 2,10**
Consumi panca 2 posti pelle / 2-seater bench leather consumption / Cuir nécessaire banc 2 places **mq 3,00**





Omologazione ministeriale al fuoco in classe 1IM con rivestimento PLANET o BINGO ELAST / MIRAGE e poliuretano ignifugo (+6% da listino)
 Fireproof Italian Ministry homologation in 1IM class with upholstery PLANET or BINGO ELAST / MIRAGE and fire retardant polyurethane (+6% to price list)
 Certification Italienne contre le feu en classe 1IM avec revêtement PLANET ou BINGO ELAST/MIRAGE et polyuréthane ignifuge (+6% sur le tarif)



Ignifugo + extra 6% da listino prezzi
 Fireproof + extra 6% to price list
 Non feu + extra 6% sur le tarif

Jazz

- **Telaio in metallo cromato o nero**
Chromed or black painted frame
Structure chromé ou peint noir
- **Imbottitura in poliuretano espanso**
Polyurethane foam padding
Rembourrage en mousse de polyuréthane
- **Struttura in legno**
Inner structure in wood
Structure en bois multiplis

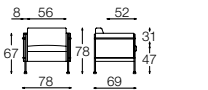
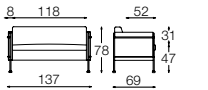
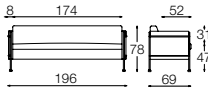
			Cat. F	Cat. G	Cat. S	Cat. TOP	Cat. EXTRA	Pelle Leather Cuir FIESTA	Pelle Leather Cuir NUVOLA	 mc	 kg
JZPL	Poltrona Armchair Fauteuil		948	982	1.064	1.099	1.169	1.373	1.611	0.56	33.2
JZD2	Divano 2 posti 2-seater sofa Canapé 2 places		1.137	1.184	1.293	1.340	1.433	1.702	2.011	0.91	38
JZD3	Divano 3 posti 3-seater sofa Canapé 3 places		1.326	1.402	1.580	1.658	1.810	1.947	2.304	1.19	45.5

OPTIONAL: TELAIO NERO STESSO PREZZO SPECIFICARE "NR" ALLA FINE DEL CODICE

OPTIONAL: BLACK FRAME - SAME PRICE - JUST SPECIFY "NR" AT THE END OF THE CODE

OPTIONAL: STRUCTURE NOIR - MEME PRIX - SPECIFIER "NR" APRES LE CODE

Consumi poltrona tessuto / Armchair fabric consumption / Tissu nécessaire fauteuil **ml 3,00**

Consumi poltrona pelle / Armchair leather consumption / Cuir nécessaire fauteuil **mq 5,50**

Consumi divano 2 posti tessuto / 2-seater sofa fabric consumption / Tissu nécessaire canapé 2 places **ml 4,00**

Consumi divano 2 posti pelle / 2-seater sofa leather consumption / Cuir nécessaire canapé 2 places **mq 7,20**

Consumi divano 3 posti tessuto / 3-seater sofa fabric consumption / Tissu nécessaire canapé 3 places **ml 6,50**

Consumi divano 3 posti pelle / 3-seater sofa leather consumption / Cuir nécessaire canapé 3 places **mq 8,30**



Omologazione ministeriale al fuoco in classe 1IM con rivestimento PLANET o BINGO ELAST / MIRAGE e poliuretano ignifugo (+6% da listino)

Fireproof Italian Ministry homologation in 1IM class with upholstery PLANET or BINGO ELAST / MIRAGE and fire retardant polyurethane (+6% to price list)

Certification Italienne contre le feu en classe 1IM avec revêtement PLANET ou BINGO ELAST/MIRAGE et polyuréthane ignifuge (+6% sur le tarif)







Ignifugo + extra 6% da listino prezzi

Fireproof + extra 6% to price list

Non feu + extra 6% sur le tarif

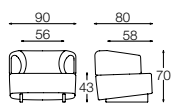
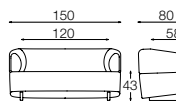
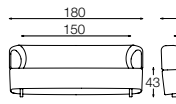
- **Imbottitura in poliuretano espanso**
Polyurethane foam padding
Rembourrage en mousse de polyuréthane
- **Struttura in legno**
Inner structure in wood
Structure en bois multiplis
- **Piedini in legno verniciati neri**
Black lacquered wood feet
Pieds en bois laqué noir

			Cat. F	Cat. G	Cat. S	Cat. TOP	Cat. EXTRA	Pelle Leather Cuir FIESTA	Pelle Leather Cuir NUVOLA	 mc	 kg
LFDV1	Poltrona Armchair Fauteuil		975	996	1.102	1.124	1.261	1.314	1.442	0.62	30
LFDV2	Divano 2 posti 2-seater sofa Canapé 2 places		1.219	1.251	1.420	1.452	1.664	1.707	1.887	1.04	44.1
LFDV3	Divano 3 posti 3-seater sofa Canapé 3 places		1.420	1.463	1.664	1.696	1.961	2.003	2.215	1.37	51

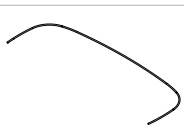
Accessori / Accessories / Accessoires		Prezzo unitario € Unit price € Prix Unitaire €	
LFAC1NR	Decorazione verniciata nera poltrona Black lacquered detail for armchair Détail peinte noir pour fauteuil		58
LFAC2NR	Decorazione verniciata nera 2 posti Black lacquered detail for 2-seater sofa Détail peinte noir pour canapé 2 places		90
LFAC3NR	Decorazione verniciata nera 3 posti Black lacquered detail for 3-seater sofa Détail peinte noir pour canapé 3 places		122

Consumi poltrona tessuto / Armchair fabric consumption / Tissu nécessaire fauteuil **ml 3,40**

Consumi poltrona pelle / Armchair leather consumption / Cuir nécessaire fauteuil **mq 4,50**

Consumi divano 2 posti tessuto / 2-seater sofa fabric consumption / Tissu nécessaire canapé 2 places **ml 5,20**

Consumi divano 2 posti pelle / 2-seater sofa leather consumption / Cuir nécessaire canapé 2 places **mq 6,40**

Consumi divano 3 posti tessuto / 3-seater sofa fabric consumption / Tissu nécessaire canapé 3 places **ml 6,40**

Consumi divano 3 posti pelle / 3-seater sofa leather consumption / Cuir nécessaire canapé 3 places **mq 8,00**



Omologazione ministeriale al fuoco in classe 1IM con rivestimento PLANET o BINGO ELAST / MIRAGE e poliuretano ignifugo (+6% da listino) IN CORSO
Fireproof Italian Ministry homologation in 1IM class with upholstery PLANET or BINGO ELAST / MIRAGE and fire retardant polyurethane (+6% to price list) ONGOING
Certification Italienne contre le feu en classe 1IM avec revêtement PLANET ou BINGO ELAST/MIRAGE et polyuréthane ignifuge (+6% sur le tarif) EN COURS



Ignifugo + extra 6% da listino prezzi
Fireproof + extra 6% to price list
Non feu + extra 6% sur le tarif

Miss Lounge

- **Telaio in metallo**
Metal frame structure
Structure en métal
- **Imbottitura in poliuretano espanso**
Polyurethane foam padding
Rembourrage en mousse de polyuréthane
- **Struttura in legno**
Inner structure in wood
Structure en bois multiplis

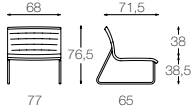
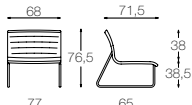
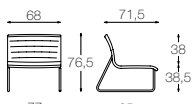
			Cat. F	Cat. G	Cat. S	Cat. TOP	Cat. EXTRA	Pelle Leather Cuir FIESTA	Pelle Leather Cuir NUVOLA	mc	kg
MSVCCRC	Telaio cromato Chromed frame Piètement chromé		519	531	588	598	641	717	822	0.56	14.2
MSVCNRC	Telaio nero Black frame Piètement noir		519	531	588	598	641	717	822	0.56	14.2
MSVCBCC	Telaio bianco White frame Piètement blanc		519	531	588	598	641	717	822	0.56	14.2

Consumi tessuto / Fabric consumption / Tissu nécessaire **ml 1,70**

Consumi pelle / Consumption leather / Cuir nécessaire **mq 2,90**



Omologazione ministeriale al fuoco in classe 1IM con rivestimento PLANET o BINGO ELAST / MIRAGE e poliuretano ignifugo (+6% da listino)

Fireproof Italian Ministry homologation in 1IM class with upholstery PLANET or BINGO ELAST / MIRAGE and fire retardant polyurethane (+6% to price list)

Certification Italienne contre le feu en classe 1IM avec revêtement PLANET ou BINGO ELAST/MIRAGE et polyuréthane ignifuge (+6% sur le tarif)



Ignifugo + extra 6% da listino prezzi

Fireproof + extra 6% to price list

Non feu + extra 6% sur le tarif

Snake

EN 16139

EN-1728

EN-1022

■ **Telaio in metallo**

Metal frame structure
Structure en métal

■ **Imbottitura in poliuretano espanso**

Polyurethane foam padding
Rembourrage en mousse de polyuréthane

■ **Piano in HPL**

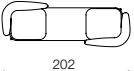
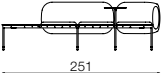
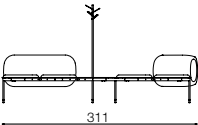
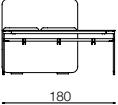

Top in HPL
Plateau en HPL

			Cat. F	Cat. G	Cat. S	Cat. TOP	Cat. EXTRA	Pelle Leather Cuir FIESTA	Pelle Leather Cuir NUVOLA	mc	kg
Idee composizioni Ideas for compositions Idées pour compositions											
Mod. 1	1 X SKP2H40 2 X SKSDRIV 2 X SKBRRIV		1.365	1.380	1.469	1.495	1.611	1.709	1.827		
Mod. 2	1 X SKP3H40 2 X SKSDRIV 2 X SKBRRIV		1.598	1.613	1.702	1.728	1.844	1.942	2.061		
Mod. 3	1 X SKP4H40 3 X SKSDRIV 1 X SKBRRIV 1 X SKSHRIV 1 X SKAC7 1 X SKAC6EUNR		2.209	2.227	2.331	2.363	2.487	2.603	2.738		
Mod. 4	1 X SKPR2H40 1 X SKPR3H40 1 X SKGIH40 4 X SKSDRIV 1 X SKSHRIV 1 X SKBRRIV 1 X SKAC5		2.344	2.364	2.477	2.513	2.649	2.778	2.927		
Mod. 5	1 X SKP3H70 2 X SKSDRIV 2 X SKAACPP 1 X SKPT12H12NR		2.050	2.065	2.174	2.198	2.338	-	-		

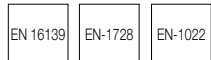
Snake



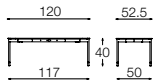
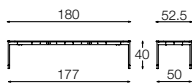
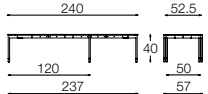
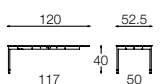
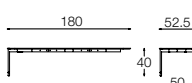
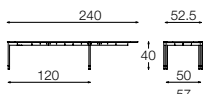
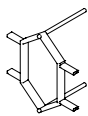

- **Telaio in metallo**
Metal frame structure
Structure en métal
- **Imbottitura in poliuretano espanso**
Polyurethane foam padding
Rembourrage en mousse de polyuréthane
- **Piano in HPL**
Top in HPL
Plateau en HPL





		Prezzo unitario € Unit price € Prix Unitaire €	 mc	 kg
SKP2H40	<p>Panca 2 posti H 40 Bianco (BC) o Nero (NR) 2-seater bench H 40 White (BC) or Black (NR) Banc 2 places H 40 Blanc (BC) ou Noir (NR)</p> 	594	0.15	23.6
SKP3H40	<p>Panca 3 posti H 40 Bianco (BC) o Nero (NR) 3-seater bench H 40 White (BC) or Black (NR) Banc 3 places H 40 Blanc (BC) ou Noir (NR)</p> 	827	0.2	33.2
SKP4H40	<p>Panca 4 posti H 40 Bianco (BC) o Nero (NR) 4-seater bench H 40 White (BC) or Black (NR) Banc 4 places H 40 Blanc (BC) ou Noir (NR)</p> 	1.055	0.25	43
SKPR2H40	<p>Panca raccordo 2 posti H 40 Bianco (BC) o Nero (NR) 2-seater not self-standing bench H 40 White (BC) or Black (NR) Banc à fixer 2 places Blanc (BC) ou Noir (NR)</p> 	504	0.15	21.6
SKPR3H40	<p>Panca raccordo 3 posti H 40 Bianco (BC) o Nero (NR) 3-seater not self-standing bench H 40 White (BC) or Black (NR) Banc à fixer 3 places Blanc (BC) ou Noir (NR)</p> 	742	0.2	31.2
SKPR4H40	<p>Panca raccordo 4 posti H 40 Bianco (BC) o Nero (NR) 4-seater not self-standing bench H 40 White (BC) or Black (NR) Banc à fixer 4 places Blanc (BC) ou Noir (NR)</p> 	965	0.25	41
Accessori / Accessories / Accessoires		Prezzo unitario € Unit price € Prix Unitaire €		
SKGIH40	<p>Gamba intermedia per unione panche Bianco (BC) o Nero (NR) Middle leg to fix two benches together White (BC) or Black (NR) Pied intermédiaire pour joindre les bancs Blanc (BC) ou Noir (NR)</p> 	154		

Snake

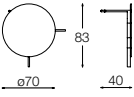
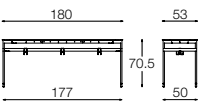
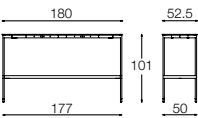
EN 16139	EN-1728	EN-1022
----------	---------	---------

- **Telaio in metallo**
Metal frame structure
Structure en métal
- **Imbottitura in poliuretano espanso**
Polyurethane foam padding
Rembourrage en mousse de polyuréthane
- **Piano in HPL**
Top in HPL
Plateau en HPL

		Prezzo unitario € Unit price € Prix Unitaire €			
				mc	kg
SKTR70_V	<p>Tavolino angolo per panca D 70 Bianco (BC) o Nero (NR) Not self-standing corner table for bench D 70 White (BC) or Black (NR) Table bas angle pour banc D 70 Blanc (BC) ou Noir (NR)</p> 	466		0.05	6
SKP3H70_	<p>Panca/tavolo 3 posti H 70 Bianco (BC) o Nero (NR) 3-seater bench/table 3 posti H 70 White (BC) or Black (NR) Banc/table 3 places H 70 Blanc (BC) ou Noir (NR)</p> 	954		0.22	35
SKPTH100_	<p>Tavolo 3 posti H 100 Bianco (BC) o Nero (NR) 3-places table H 100 White (BC) or Black (NR) Table 3 places H 100 Blanc (BC) ou Noir (NR)</p> 	996		0.24	36

Accessori / Accessories / Accessoires	Cat. F	Cat. G	Cat. S	Cat. TOP	Cat. EXTRA	Pelle Leather Cuir FIESTA	Pelle Leather Cuir NUVOLA
SKSDRIV Sedile imbottito e rivestito Padded and upholstered seat Assise rembourré et revêtu 	71	73	83	87	99	111	125
SKSHRIV Schienale 2 posti imbottito e rivestito Padded and upholstered 2-places backrest Dossier 2 places rembourré et revêtu 	271	278	318	329	371	413	461
SKBRRIV Bracciolo a L imbottito e rivestito DX o SX Padded and upholstered L-shape arm Right or Left Accoudoir à L rembourré et revêtu - droit ou gauche 	315	320	355	364	410	446	492
SKAC8 Cuscino poggiatesta 48x22 cm Cushion 48x22 cm Coussin 48x22 cm 	90	93	101	104	114	127	138

Consumi tessuto sedile / Seat fabric consumption / Tissu nécessaire assise **ml 0,60**

Consumi pelle sedile / Seat leather consumption / Cuir nécessaire assise **mq 0,90**

Consumi tessuto schienale / Back fabric consumption / Tissu nécessaire dossier **ml 1,40**

Consumi pelle schienale / Back leather consumption / Cuir nécessaire dossier **mq 2,00**

Consumi tessuto bracciolo / Arm fabric consumption / Tissu nécessaire accoudoir **ml 1,30**

Consumi pelle bracciolo / Arm leather consumption / Cuir nécessaire accoudoir **mq 1,80**



Omologazione ministeriale al fuoco in classe 1IM con rivestimento PLANET o BINGO ELAST / MIRAGE e poliuretano ignifugo (+6% da listino)

Fireproof Italian Ministry homologation in 1IM class with upholstery PLANET or BINGO ELAST / MIRAGE and fire retardant polyurethane (+6% to price list)

Certification Italienne contre le feu en classe 1IM avec revêtement PLANET ou BINGO ELAST/MIRAGE et polyuréthane ignifuge (+6% sur le tarif)



Ignifugo + extra 6% da listino prezzi









Fireproof + extra 6% to price list

Non feu + extra 6% sur le tarif

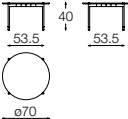
Snake

EN 16139	EN-1728	EN-1022
----------	---------	---------

- **Telaio in metallo**
Metal frame structure
Structure en métal
- **Imbottitura in poliuretano espanso**
Polyurethane foam padding
Rembourrage en mousse de polyuréthane
- **Piano in HPL**
Top in HPL
Plateau en HPL

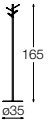
Accessori / Accessories / Accessoires			Prezzo unitario € Unit price € Prix Unitaire €	 mc	 kg
SKTV70__	<p>Tavolino D 70 Bianco (BC) o Nero (NR) Coffee table D 70 White (BC) or Black (NR)</p> <p>Table bas D 70 Blanc (BC) ou Noir (NR)</p> 		392	0.35	11.2
SKAC1NR	<p>Appendiborse solo Panca H 70 nero Bag hanger only for bench H 70 black painted</p> <p>Accroche de sac pour banc H 70 Noir (NR)</p> 		37	-	0.5
SKAC5__	<p>Appendiabiti H 155 Bianco (BC) o Nero (NR) Coat stand H 155 White (BC) or Black (NR)</p> <p>Porte-manteau H 155 Blanc (BC) ou Noir (NR)</p> 		175	-	2
SKAC6EUNR	<p>Presa USB/Schuko Europa nera* USB / Schuko Socket black</p> <p>Prise USB/ Schuko Noir</p> 		196	-	1
SKAC7__	<p>Tavolino scrittoio girevole D 35 Bianco (BC) o Nero (NR) Round writing table D 35 White (BC) or Black (NR)</p> <p>Petite table pivotant D 35 Blanc (BC) ou Noir (NR)</p> 		159	-	2.5
			Prezzo unitario € Unit price € Prix Unitaire €	 mc	 kg
ATTACCAPANNI A STELO COAT STAND PORTE-MANTEAU					
SKAPBP__	<p>Bianco (BC) o Nero (NR) White (BC) or Black (NR)</p> <p>Blanc (BC) ou Noir (NR)</p> 		175	0.01	7

* AVAILABLE BS 1363 PLUG/SOCKET PLEASE SPECIFY IT IN THE ORDER PRICE DOESN'T CHANGE

US or OTHER THAN ITALIAN SOKETS AVAILABLE - PRICE ON DEMAND - PLEASE CONTACT DIEMME
PRISES POUR AUTRES PAIS DISPONIBLES - PRIX SUR DEMANDE - MERCI DE CONTACTER DIEMME

Snake

EN 16139	EN-1728	EN-1022
----------	---------	---------

- **Struttura in legno**
Inner structure in wood
Structure en bois
- **Imbottitura in poliuretano espanso**
Polyurethane foam padding
Rembourrage en mousse de polyuréthane
- **Piedi in metallo verniciato nero**
Black metal lacquered feet
Pieds en métal peint noir

	Cat. F	Cat. G	Cat. S	Cat. TOP	Cat. EXTRA	Pelle Leather Cuir FIESTA	Pelle Leather Cuir NUVOLA	mc	kg
PARETE PARTITION CLOISON									
SKPT12H12NR Paretina rivestita 120X120 piedini neri Upholstered partition 120X120 black feet Cloison revêtu 120X120 pieds noir	827	843	943	965	1.081	-	-	0.25	30
SKPT12H16NR Paretina rivestita 120X160 piedini neri Upholstered partition 120X160 black feet Cloison revêtu 120X160 pieds noir	933	954	1.071	1.102	1.240	-	-	0.32	36
SKPT18H16NR Paretina rivestita 180X160 piedini neri Upholstered partition 180X160 black feet Cloison revêtu 180X160 pieds noir	1.060	1.097	1.309	1.346	1.617	-	-	0.47	47

Accessori / Accessories / Accessoires	Prezzo unitario € Unit price € Prix Unitaire €
SKAACPP** Aggancio unione parete e panca Bianco (BC) o Nero (NR) Fixing link between partition and bench White (BC) or Black (NR) Accroche pour cloison et banc Blanc (BC) ou Noir (NR)	32
SKAC2NR Portagiacche nero Coat hanger black painted Porte-veste Noir (NR)	85
SKAC3NR Portaoggetti nero Suspended shelving black painted Porte-objets Noir (NR)	64
SKAC4NR Portariviste nero Magazine rack black painted Porte-revues Noir (NR)	42

**** 1 pezzo se la parete è perpendicolare, 2 pezzi se parallela alla panca**

1 piece if partition is perpendicular, 2 if it is parallel to the bench
1 pièce si la cloison c'est perpendiculaire, 2 pièces si parallèle à la banc

Consumi tessuto parete 120x120 / Partition fabric consumption 120x120 / Tissu nécessaire cloison 120x120 **ml 2,80**

Consumi tessuto parete 120x160 / Partition fabric consumption 120x160 / Tissu nécessaire cloison 120x160 **ml 3,50**

Consumi tessuto parete 180x160 / Partition fabric consumption 180x160 / Tissu nécessaire cloison 180x160 **ml 6,20**



Omologazione ministeriale al fuoco in classe 1IM con rivestimento PLANET o BINGO ELAST / MIRAGE e poliuretano ignifugo (+6% da listino) IN CORSO

Fireproof Italian Ministry homologation in 1IM class with upholstery PLANET or BINGO ELAST / MIRAGE and fire retardant polyurethane (+6% to price list) ONGOING
Certification Italienne contre le feu en classe 1IM avec revêtement PLANET ou BINGO ELAST/MIRAGE et polyuréthane ignifuge (+6% sur le tarif) EN COURS







Ignifugo + extra 6% da listino prezzi

Fireproof + extra 6% to price list
Non feu + extra 6% sur le tarif

Toffee

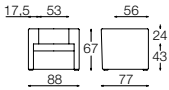
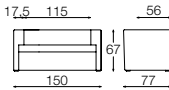
- **Imbottitura in poliuretano espanso**
Polyurethane foam padding
Rembourrage en mousse de polyuréthane
- **Struttura in legno**
Inner structure in wood
Structure en bois multiples
- **Piedini in legno verniciato nero**
Black lacquered wooden feet
Pieds en bois peint noir

			Cat. F	Cat. G	Cat. S	Cat. TOP	Cat. EXTRA	Pelle Leather Cuir FIESTA	Pelle Leather Cuir NUVOLA	 mc	 kg
TFPL	Poltrona Armchair Fauteuil		929	957	1.082	1.151	1.240	1.560	2.001	0.69	45.2
TF2P	Divano 2 posti 2-seater sofa Canapé 2 places		1.148	1.185	1.356	1.455	1.578	1.917	2.469	1.2	67.7
TF3P	Divano 3 posti 3-seater sofa Canapé 3 places		1.332	1.373	1.581	1.695	1.840	2.260	2.921	1.37	90

Consumi poltrona tessuto / Armchair fabric consumption / Tissu nécessaire fauteuil **ml 4,70**

Consumi poltrona pelle / Armchair leather consumption / Cuir nécessaire fauteuil **mq 7,20**

Consumi divano 2 posti tessuto / 2-seater sofa fabric consumption / Tissu nécessaire canapé 2 places **ml 6,50**

Consumi divano 2 posti pelle / 2-seater sofa leather consumption / Cuir nécessaire canapé 2 places **mq 10,00**

Consumi divano 3 posti tessuto / 3-seater sofa fabric consumption / Tissu nécessaire canapé 3 places **ml 7,70**

Consumi divano 3 posti pelle / 3-seater sofa leather consumption / Cuir nécessaire canapé 3 places **mq 12,00**



Omologazione ministeriale al fuoco in classe 1IM con rivestimento PLANET o BINGO ELAST / MIRAGE e poliuretano ignifugo (+6% da listino)

Fireproof Italian Ministry homologation in 1IM class with upholstery PLANET or BINGO ELAST / MIRAGE and fire retardant polyurethane (+6% to price list)

Certification Italienne contre le feu en classe 1IM avec revêtement PLANET ou BINGO ELAST/MIRAGE et polyuréthane ignifuge (+6% sur le tarif)



Ignifugo + extra 6% da listino prezzi

Fireproof + extra 6% to price list

Non feu + extra 6% sur le tarif

“Semplici, moderni e di design,
i complementi d’arredo Diemme,
con giochi di contrasto,
oppure
con accostamenti tono su tono,
conferiscono carattere agli ambienti.
Perfetti per arredare zone lounge,
luoghi di condivisione e
spazi di attesa contemporanei.”

Complementi

Accessories / Accessoires

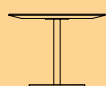

BREAD
128



CIRCUIT
130

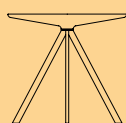

MARGARITA
131

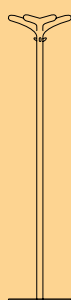

ROCKET
132



SNAKE
133

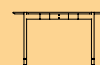

SNAKE
134





XL - XS
135

“With simple modern design, Diemme’s furnishing accessories, featuring contrasting colours or a two-tone look, add a touch of style to any setting. Ideal for lounges, community and contemporary waiting areas.”

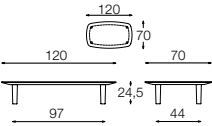
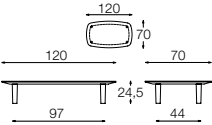
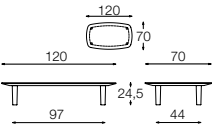
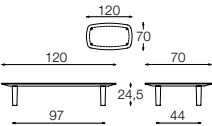
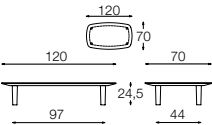
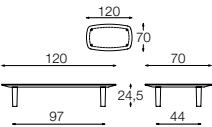

Bread

- **Piedini in rovere naturale**
Oak feet
Pieds en bois de chêne
- **Piano in MDF**
MDF top
Tableau en MDF

			Prezzo unitario €		
			Unit price €	mc	kg
			Prix Unitaire €		
Tavolino rettangolare 120x70 cm, altezza 23 cm Table rectangular 120x70 cm, height 23 cm Table rectangulaire 120x70 cm, height 23 cm					
BRREBCBC	Piano bianco e piedi verniciati bianchi White top and feet in oak white lacquered Plateau blanc et pieds peints blanc		555	0.07	23
BRREBCRV	Piano bianco e piedi rovere naturale White top and feet in natural oak Plateau blanc et pieds chêne naturel		555	0.07	23
BRREANBC	Piano antracite e piedi verniciati bianchi Dark grey top and feet in oak white lacquered Plateau anthracite et pieds peints blanc		555	0.07	23
BRREANRV	Piano antracite e piedi rovere naturale Dark grey top and feet in natural oak Plateau anthracite et pieds chêne naturel		555	0.07	23
BRRERVBC	Piano rovere e piedi verniciati bianchi Oak top and feet in oak white lacquered Plateau en chêne et pieds peints blanc		623	0.07	23
BRRERV RV	Piano rovere e piedi rovere naturale Oak top and feet in natural oak Plateau chêne et pieds chêne naturel		623	0.07	23

Bread

- **Piedini in rovere naturale**
Oak feet
Pieds en bois de chêne
- **Piano in MDF**
MDF top
Tableau en MDF

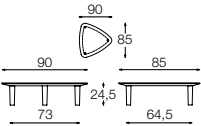
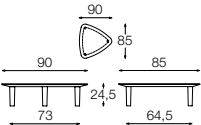
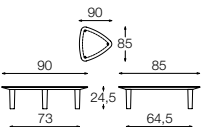
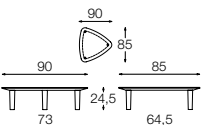
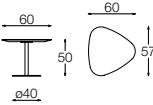
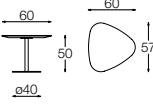
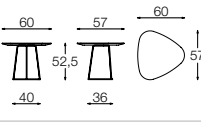
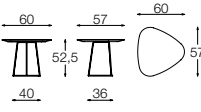
			Prezzo unitario € Unit price € Prix Unitaire €	 mc	 kg
Tavolino triangolare grande 90x85 cm, altezza 23 cm Big table triangular 90x85 cm, height 23 cm Grand table triangulaire 90x85 cm, height 23 cm					
BRTGBCBC	Piano bianco e piedi verniciati bianchi White top and feet in oak white lacquered Plateau blanc et pieds peints blanc		510	0.06	12.5
BRTGBCRV	Piano bianco e piedi rovere naturale White top and feet in natural oak Plateau blanc et pieds chêne naturel		510	0.06	12.5
BRTGANBC	Piano antracite e piedi verniciati bianchi Dark grey top and feet in oak white lacquered Plateau anthracite et pieds peints blanc		510	0.06	12.5
BRTGANRV	Piano antracite e piedi rovere naturale Dark grey top and feet in natural oak Plateau anthracite et pieds chêne naturel		510	0.06	12.5
Tavolino triangolare piccolo 60x57 cm, altezza 50 cm Small table triangular 60x57 cm, height 50 cm Petit table triangulaire 60x57 cm, height 50 cm					
BRTPBCCR	Piano bianco e base cromata White top and chromed base Plateau blanc et piètement chromé		485	0.17	10
BRTPANCR	Piano antracite e base cromata Dark grey and chromed base Plateau anthracite et piètement chromé		485	0.17	10
BRTPBCBC	Piano bianco e telaio verniciato bianco White top and white frame Plateau blanc et piètement peint blanc		346	0.14	14.7
BRTPANBC	Piano antracite e telaio verniciato bianco Dark grey top and white frame Plateau anthracite et piètement peint blanc		346	0.14	14.7



Circuit

■ **Struttura in metallo verniciato**

Metal lacquered frame
Structure en métal peint

■ **Piano in HPL**

HPL top
Tableau en HPL

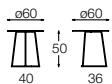
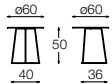
		Prezzo unitario € Unit price € Prix Unitaire €		 mc	 kg
Tavolo altezza 50 cm, diametro 60 cm Table height 50 cm, diameter 60 cm Table hauteur 50cm, diamètre 60cm					
CI600BIBI	<p>Tavolino tondo, top e struttura bianca</p> <p>Round table, white top and structure Table ronde ,plateau et piètement blanc</p> 	272	0.16	7.6	
CI600NRNR	<p>Tavolino tondo, top e struttura nera</p> <p>Round table, black top and structure Table ronde ,plateau et piètement noir</p> 	272	0.16	7.6	









Margarita

■ **Struttura in metallo verniciato**

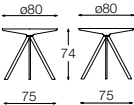
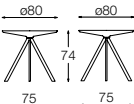
Lacquered metal structure
Structure en métal peint



■ **Piano in polietilene**

Polyethylene top
Tableau en polyéthylène

		Prezzo unitario € Unit price € Prix Unitaire €	 mc	 kg
Tavolino rotondo, diametro 80 cm, telaio 4 gambe H 74 cm Round table, 80 cm diameter, 4 legs frame 74 cm H Table ronde, 80cm diamètre, 4 pieds h 74cm				
MARAN4GAN74	Piano antracite e gambe antracite Dark grey top and dark grey frame Plateau anthracite et piètement anthracite		356	0.32 14.5
MARBC4GBC74	Piano bianco e gambe bianche White top and white frame Plateau blanc et piètement blanc		356	0.32 14.5
Tavolo rotondo, diametro 80 cm, base conica Round table, 80 cm diameter, conic frame Table ronde, 80cm diamètre, piètement conique				
MARANCOAN50	Piano antracite e base antracite H 50 cm Dark grey top and dark grey frame, 50 cm H Plateau anthracite et piètement anthracite H 50 cm		487	0.2 24.5
MARBCCOBC50	Piano bianco e base bianca, H 50 cm White top and white frame, 50 cm H Plateau blanc et piètement blanc H 50 cm		487	0.2 24.5
MARANCOAN74	Piano antracite e base antracite H 74 cm Dark grey top and dark grey frame, 74 cm H Plateau anthracite et piètement anthracite H 74 cm		510	0.2 25.5
MARBCCOBC74	Piano bianco e base bianca, H 74 cm White top and white frame, 74 cm H Plateau blanc et piètement blanc H 74 cm		510	0.2 25.5
MARANCOAN110	Piano antracite e base antracite H 110 cm Dark grey top and dark grey frame, 110 cm H Plateau anthracite et piètement anthracite H 110 cm		534	0.2 26.5
MARBCCOBC110	Piano bianco e base bianca, H 110 cm White top and white frame, 110 cm H Plateau blanc et piètement conique blanc H 110 cm		534	0.2 26.5

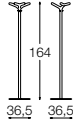
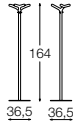
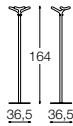
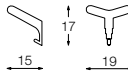
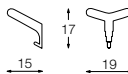
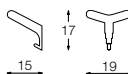

Rocket

■ **Struttura in metallo verniciato**
 Structure in metal epoxy-coated
 Structure en métal peint

				Prezzo unitario €			
				Unit price €	Prix Unitaire €	mc	kg
ATTACCAPANNI A STELO con portaombrelli base tonda COAT STAND with umbrella holder, round base PORTEMANTEAU avec porte-parapluie, base ronde							
RKAPBPBC	Bianco White Blanc			249		0.01	9.5
RKAPBPNR	Nero Black Noir			249		0.01	9.5
RKAPBPRO	Rosso Red Rouge			249		0.01	9.5
ATTACCAPANNI A PARETE Gancio a parete singolo (1pz) WALL-MOUNTED COAT RACK Wall -mounted single coat rack (1pc) PORTEMANTEAU MURAL (1pc)							
RKAPPABC	Bianco White Blanc			25		0.005	1
RKAPPANR	Nero Black Noir			25		0.005	1
RKAPPARO	Rosso Red Rouge			25		0.005	1

Snake

■ **Struttura In metallo verniciato**
 Structure in metal epoxy-coated
 Structure en métal peint

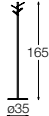
		Prezzo unitario € Unit price € Prix Unitaire €	 mc	 kg
ATTACCAPANNI A STELO COAT STAND PORTE-MANTEAU				
SKAPBP__	Bianco (BC) o Nero (NR) White (BC) or Black (NR) Blanc (BC) ou Noir (NR) 	175	0.01	7

Snake

- **Telaio in metallo**
Metal frame structure
Structure en métal
- **Piano in HPL**
Top in HPL
Plateau en HPL

TAVOLINO COFFEE TABLE TABLE BAS		Prezzo unitario € Unit price € Prix Unitaire €	 mc	 kg
SKTV70 ___	<p>Tavolino D 70 Bianco (BC) o Nero (NR) Coffee table D 70 White (BC) or Black (NR) Table bas D 70 Blanc (BC) ou Noir (NR)</p> 	392	0.35	11.2



XL - XS

■ **Struttura in metallo verniciato**

Lacquered metal structure
Structure en métal peint

■ **Piano in HPL**

Top in HPL
Tableau en HPL

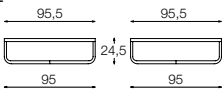
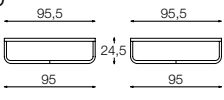
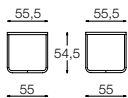
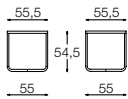
		Prezzo unitario € Unit price € Prix Unitaire €	 mc	 kg
XL Tavolo basso, alt. 25 cm, piano 95x95 cm XL Low table, height 25 cm, top 95x95 cm XL table basse h.25cm, plateau 95x95cm				
XLBCV_	<p>Piano bianco in HPL, telaio BIANCO (B) o NERO (N)</p> <p>White HPL top, frame WHITE (B) or BLACK (N)</p> <p>Top en HPL blanc, piètement BLANC (B) ou NOIR (N)</p> 	750	0.3	21.3
XLNRV_	<p>Piano nero in HPL, telaio BIANCO (B) o NERO (N)</p> <p>Black HPL top, frame WHITE (B) or BLACK (N)</p> <p>Top en HPL noir, piètement BLANC (B) ou NOIR (N)</p> 	750	0.3	21.3
XS Tavolo alto, alt. 55 cm, piano 55x55 cm XS High table, height 55 cm, top 55x55 cm XS table haut h.55cm, plateau 55x55cm				
XSBCV_	<p>Piano bianco in HPL, telaio BIANCO (B) o NERO (N)</p> <p>White HPL top, frame WHITE (B) or BLACK (N)</p> <p>Top en HPL blanc, piètement BLANC (B) ou NOIR (N)</p> 	582	0.32	11.65
XSNRV_	<p>Piano nero in HPL, telaio BIANCO (B) o NERO (N)</p> <p>Black HPL top, frame WHITE (B) or BLACK (N)</p> <p>Top en HPL noir, piètement BLANC (B) ou NOIR (N)</p> 	582	0.32	11.65



Distributor pro ČR a SK

www.mintiga.cz

obchod@mintiga.cz

+420 724 124 042

kire



Distributor pro ČR a SK
www.mintiga.cz
obchod@mintiga.cz
+420 724 124 042

Diemme.

KIRE PRICELIST 2022

KIRE

LISTINO PREZZI - PRICELIST



SEDIA 4 GAMBE metallo - 4 LEGS metal FRAME

Scocca in polipropilene - Shell in polypropylene

Telaio 4 gambe 16mm nero, bianco, cromato - 4 legs metal frame

IMPILABILE 6 PEZZI / 4 PZ CON TAVOLETTA - STACKABLE UP TO 6 PC / 4PC with tablet

MINIMO ORDINE 2 PEZZI - MINIMUM ORDER 2 PC

	POLIPROPILENE	POLYPROPYLENE	
	Telaio NERO o BIANCO	Black or White 4 legs	160 €
	Telaio CROMATO	Chromed 4 legs	170 €

Accessori			F	G	S	Top	Extra	Fiesta	Nuvola
KISDRIV	Sedile imbottito rivestito	Seat Padded	54 €	57 €	69 €	71 €	80 €	105 €	115 €
CPTVFNRNR	Tavoletta scrittoio nylon nero supporto nero o bianco	Black nylon writing desk black or white support				70 €			
**	Telaio verniciato tinta scocca * minimo ordine 10pz*	Laquered frame as per shell color *minimum order 10 pc*				30 €			

POLIPROPILENE | Polypropylene | Polypropylène / KIRE

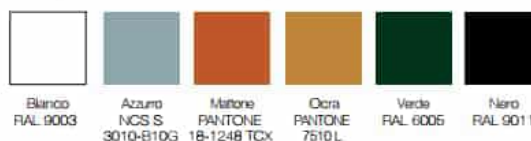

KIRE SOFT

SEDIA 4 GAMBE metallo - SCOCCA RIVESTITA - 4 LEGS METAL FRAME - FULLY UPHOLSTERED SHELL

	VERSIONE RIVESTITA	FULLY UPHOLSTERED	F*	G	S	Top*	Extra	CUOIO
	Telaio NERO o BIANCO	Black or White 4 legs	349	353	365	384	406	504
	Telaio CROMATO	Chromed 4 legs	359	363	375	394	416	514

* Non disponibile/ Not available in PLANET e IKON

Accessori			
CPTVFNRNR	Tavoletta scrittoio nylon nero supporto nero o bianco	Black nylon writing tablet black or white support	70 €

KIRE

LISTINO PREZZI - PRICELIST



SEDIA SLITTA - SLED FRAME

Scocca in polipropilene - Shell in polypropylene

Telaio slitta tondino acciaio 11mm - Sled metal frame 11mm

IMPILABILE 6 PEZZI / 4 PZ CON TAVOLETTA - STACKABLE UP TO 6 PC / 4PC with tablet

MINIMO ORDINE 2 PEZZI - MINIMUM ORDER 2 PC

	POLIPROPILENE	POLYPROPYLENE	
	Telaio NERO o BIANCO	Black or White lacquered sled	180 €

Accessori		F	G	S	Top	Extra	Fiesta	Nuvola
KISDRIV	Sedile imbottito rivestito Seat Padded	54 €	57 €	69 €	71 €	80 €	105 €	115 €
	Coppia braccioli bianchi o neri con copri bracciolo bianco o nero Pair of arms black or white with cover black or white	75 €						
	Bracciolo singolo con tavoletta antipanico nylon nero (sx guardando) Single amrs with writing desk black nylon (left in front)	105 €						
	Ganci per allineamento Linking for chairs	13 €						

POLIPROPILENE | Polypropylene | Polypropylène / KIRE



KIRE SOFT

SEDIA SLITTA - SCOCCA RIVESTITA - SLED FRAME FULLY UPHOLSTERED SHELL

Code	Finish	Structure	F*	G	S	Top*	Extra	CUOIO
	VERSIONE RIVESTITA Telaio NERO o BIANCO	FULLY UPHOLSTERED Black or White lacquered sled	379 €	383 €	395 €	414 €	436 €	534 €

* Non disponibile/ Not available in PLANET e IKON

Accessori		
	Coppia braccioli bianchi o neri con copri bracciolo bianco o nero Pair of arms black or white with cover black or white	75 €
	Bracciolo singolo con tavoletta antipanico nylon nero (sx guardando) Single amrs with writing desk black nylon (left in front)	105 €
	Ganci per allineamento Linking for chairs	13 €

KIRE

LISTINO PREZZI - PRICELIST



TELAIO 4 RAZZE girevole in nylon - 4 STAR POLYPROPYLENE SWIVEL FRAME

Scocca in polipropilene - Shell in polypropylene

Telaio girevole in nylon bianco o nero su piedini - Black or white polypropylene frame on feet, swivel

	POLIPROPILENE	POLYPROPYLENE	
	Telaio NERO o BIANCO	Black or White frame	183 €

Accessori		F	G	S	Top	Extra	Fiesta	Nuvola
KISDRIV	Sedile imbottito rivestito Seat Padded	54 €	57 €	69 €	71 €	80 €	105 €	115 €

POLIPROPILENE | Polypropylene | Polypropylène / KIRE

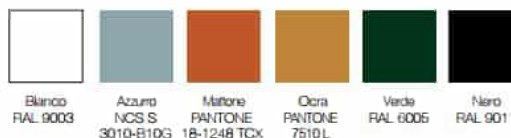

KIRE SOFT

TELAIO 4 RAZZE girevole in nylon - 4 STAR POLYPROPYLENE SWIVEL FRAME

SCOCCA RIVESTITA FULLY UPHOLSTERED SHELL

Code	Finish	Structure	F*	G	S	Top*	Extra	CUOIO
	VERSIONE RIVESTITA	FULLY UPHOLSTERED						
	Telaio NERO o BIANCO	Black or White frame	384 €	388 €	400 €	419 €	441 €	539 €

* Non disponibile/ Not available in PLANET e IKON

KIRE

LISTINO PREZZI - PRICELIST

BASE 5 RAZZE SU RUOTE, REGOLAZIONE A GAS - 5 STAR NYLON BASE ON CASTORS, GASLIFT

Scocca in polipropilene - Shell in polypropylene

Base a 5 razze su ruote gommata in nylon nero o bianco - 5 star nylon base black or white, rubber castors



	POLIPROPILENE Base 5 razze polipropilene NERO o BIANCO ruote nere	POLYPROPYLENE 5 star nylon base BLACK or WHITE black rubber castors	183 €
--	---	---	--------------

Accessori		F	G	S	Top	Extra	Fiesta	Nuvola
KISDRIV	Sedile imbottito rivestito Seat Padded	54 €	57 €	69 €	71 €	80 €	105 €	115 €
AL	Base alluminio Aluminium polished base	49 €						
RF__	Ruote forate Philippe Starck nero o bianco Castors with holes Philippe Starck black or white	44 €						

POLIPROPILENE | Polypropylene | Polypropylène / KIRE



KIRE SOFT

BASE 5 RAZZE SU RUOTE, REGOLAZIONE A GAS - 5 STAR NYLON BASE ON CASTORS, GASLIFT

SCOCCA RIVESTITA FULLY UPHOLSTERED SHELL

		F*	G	S	Top*	Extra	CUOIO	
	VERSIONE RIVESTITA Base 5 razze polipropilene NERO o BIANCO ruote nere	FULLY UPHOLSTERED 5 star nylon base BLACK or WHITE black rubber castors	368 €	372 €	384 €	403 €	425 €	523 €

* Non disponibile/ Not available in PLANET e IKON

Accessori		F	G	S	Top	Extra	Fiesta	Nuvola
AL	Base alluminio Aluminium polished base	49 €						
RF__	Ruote forate Philippe Starck nero o bianco Castors with holes Philippe Starck black or white	44 €						

KIRE

LISTINO PREZZI - PRICELIST

TELAIO 4 RAZZE girevole in ALLUMINIO LUCIDO, NERO, BIANCO
4 STAR SWIVEL FRAME IN POLISHED ALUMINIUM, BLACK OR WHITE ALUMINIUM

Scocca in polipropilene - Shell in polypropylene

Base a 4 razze in alluminio lucido o nero o bianco - 4 star aluminium polish or balck or white frame

On cartors or feet



Code	Finish	Structure	Pricelist
	POLIPROPILENE	POLYPROPYLENE	
	Alluminio lucido, bianco, nero ruote nere	Aluminium, polish, balck or white black rubber castors	250 €

Accessori		F	G	S	Top	Extra	Fiesta	Nuvola	
KISDRIV	Sedile imbottito rivestito	Seat Padded	54 €	57 €	69 €	71 €	80 €	105 €	115 €
RF	Ruote forate Philippe Starck nero o bianco	Castors with holes Philippe Starck black or white	44 €						

POLIPROPILENE | Polypropylene | Polypropylène / KIRE

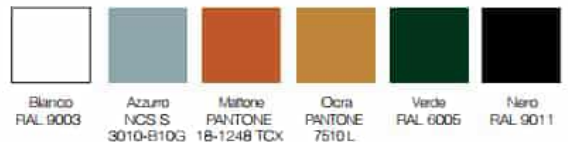

KIRE SOFT

TELAIO 4 RAZZE girevole in ALLUMINIO LUCIDO, NERO, BIANCO

4 STAR SWIVEL FRAME IN POLISHED ALUMINIUM, BLACK OR WHITE ALUMINIUM

SCOCCA RIVESTITA FULLY UPHOLSTERED SHELL

			F*	G	S	Top*	Extra	CUOIO
	VERSIONE RIVESTITA	FULLY UPHOLSTERED						
	Alluminio lucido, bianco, nero ruote nere	Aluminium, polish, balck or white black rubber castors	431 €	435 €	447 €	466 €	488 €	586 €

* Non disponibile/ Not available in PLANET e IKON

Accessori			
RF__	Ruote forate Philippe Starck nero o bianco	Castors with holes Philippe Starck black or white	44 €

KIRE

LISTINO PREZZI - PRICELIST

SEDIA 4 GAMBE LEGNO - 4 LEGS FRAME IN WOOD

Scocca in polipropilene - Shell in polypropylene

Telaio 4 gambe in frassino verniciato naturale o laccato nero - 4 legs frame in ash wood natural or black



	POLIPROPILENE	POLYPROPYLENE	
	Frassino naturale o nero	Ash wood natural or black	330 €

Accessori		F	G	S	Top	Extra	Fiesta	Nuvola
KISDRIV	Sedile imbottito rivestito Seat Padded	54 €	57 €	69 €	71 €	80 €	105 €	115 €
	Coppia braccioli in legno Frassino naturale o nero Pair of arms in wood Ash wood natural or black	172 €						

POLIPROPILENE | Polypropylene | Polypropylène / KIRE



KIRE SOFT

SEDIA 4 GAMBE LEGNO - SCOCCA RIVESTITA / 4 LEGS FRAME IN WOOD - FULLY UPHOLSTERED

	VERSIONE RIVESTITA	FULLY UPHOLSTERED	F*	G	S	Top*	Extra	CUOIO
	Frassino naturale o nero	Ash wood natural or black	526 €	530 €	542 €	561 €	583 €	681 €

* Non disponibile/ Not available in PLANET e IKON

Accessori		
	Coppia braccioli in legno Frassino naturale o nero Pair of arms in wood Ash wood natural or black	172 €

KIRE

LISTINO PREZZI - PRICELIST



SGABELLO 4 GAMBE BASSO seduta h.65 - LOW STOOL 4 LEGS METAL FRAME SEAT HIGHT 65cm

Scocca in polipropilene - Shell in polypropylene

Telaio 4 gambe 16mm laccato bianco, nero - 4 legs metal lacquered frame black or white

	POLIPROPILENE	POLYPROPYLENE	
	Telaio NERO o BIANCO	Black or White lacquered frame	230 €

SGABELLO 4 GAMBE ALTO seduta h.75 - HIGHT STOOL 4 LEGS METAL FRAME SEAT HIGHT 75cm

Scocca in polipropilene - Shell in polypropylene

Telaio 4 gambe 16mm laccato bianco, nero - 4 legs metal lacquered frame black or whit

	POLIPROPILENE	POLYPROPYLENE	
	Telaio NERO o BIANCO	Black or White lacquered frame	240 €

Accessori		F	G	S	Top	Extra	Fiesta	Nuvola	
KISDRIV	Sedile imbottito rivestito	Seat Padded	54 €	57 €	69 €	71 €	80 €	105 €	115 €
**	Telaio verniciato tinta scocca	Laquered frame as per shell color	30 €						
	* minimo ordine 10pz*	*minimum order 10 pc*							

POLIPROPILENE | Polypropylene | Polypropylène / KIRE



KIRE SOFT

SGABELLO 4 GAMBE BASSO seduta h.65 - LOW STOOL 4 LEGS METAL FRAME SEAT HIGHT 65cm

SCOCCA RIVESTITA FULLY UPHOLSTERED SHELL

	VERSIONE RIVESTITA	FULLY UPHOLSTERED	F*	G	S	Top*	Extra	CUOIO
	Telaio NERO o BIANCO	Black or White lacquered frame	421 €	425 €	437 €	456 €	478 €	576 €

* Non disponibile/ Not available in PLANET e IKON

KIRE SOFT

SGABELLO 4 GAMBE ALTO seduta h.75 - HIGHT STOOL 4 LEGS METAL FRAME SEAT HIGHT 75cm

SCOCCA RIVESTITA FULLY UPHOLSTERED SHELL

	VERSIONE RIVESTITA	FULLY UPHOLSTERED	F*	G	S	Top*	Extra	CUOIO
	Telaio NERO o BIANCO	Black or White lacquered frame	431 €	435 €	447 €	466 €	488 €	586 €

* Non disponibile/ Not available in PLANET e IKON

KIRE

LISTINO PREZZI - PRICELIST



SGABELLO operativo REGOLAZIONE A GAS, base 5 razze nylon nero

TASK STOOL, 5 STAR NYLON BASE, GASLIFT

Scocca in polipropilene - Shell in polypropylene

Poggiapiedi cromato - chromed feetrest

Base 5 razze in nylon nero - 5 star black nylon base

Su ruote o piedini - On castors or feet

	POLIPROPILENE	POLYPROPYLENE					
	5 razze nylon nero	5 star black nylon base	240 €				
	ruote o piedini	castors or feet					

Accessori			F	G	S	Top	Extra	Fiesta	Nuvola
KISDRIV	Sedile imbottito rivestito	Seat Padded	54 €	57 €	69 €	71 €	80 €	105 €	115 €

POLIPROPILENE | Polypropylene | Polypropylène / KIRE



KIRE SOFT

SGABELLO operativo REGOLAZIONE A GAS, base 5 razze nylon nero

TASK STOOL, 5 STAR NYLON BASE, GASLIFT

SCOCCA RIVESTITA

FULLY UPHOLSTERED SHELL

Code	Finish	Structure	F	G	S	Top	Extra	CUOIO
	VERSIONE RIVESTITA	FULLY UPHOLSTERED						
	5 razze nylon nero	5 star black nylon base	431 € 435 € 447 € 466 € 488 € 586 €					
	ruote o piedini	castors or feet						

* Non disponibile/ Not available in PLANET e IKON

KIRE

LISTINO PREZZI - PRICELIST

SGABELLO REGOLAZIONE A GAS, BASE TONDA verniciato nero

STOOL, ROUND STEEL BLACK BASE, GASLIFT

Scocca in polipropilene - Shell in polypropylene

Poggiapiedi nero - black footrest



POLIPROPILENE	POLYPROPYLENE	
Base nera	Black base	390 €

Accessori		F	G	S	Top	Extra	Fiesta	Nuvola
KISDRIV	Sedile imbottito rivestito / Seat Padded	54 €	57 €	69 €	71 €	80 €	105 €	115 €

POLIPROPILENE | Polypropylene | Polypropylène / KIRE

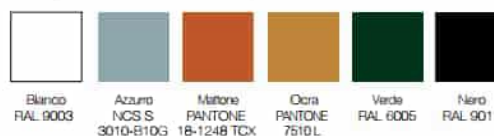

KIRE SOFT

SGABELLO REGOLAZIONE A GAS, BASE TONDA verniciato nero

STOOL, ROUND STEEL BLACK BASE, GASLIFT

SCOCCA RIVESTITA

FULLY UPHOLSTERED SHELL

VERSIONE RIVESTITA	FULLY UPHOLSTERED	F*	G	S	Top*	Extra	CUOIO
Base nera	Black base	583 €	587 €	599 €	618 €	640 €	738 €

* Non disponibile/ Not available in PLANET e IKON

KIRE

LISTINO PREZZI - PRICELIST

VERSIONE PANCA - BENCH

Scocca in polipropilene - Shell in polypropylene

Trave verniciata nera- black beam

Gambe alluminio lucido - polished aluminium legs



	POLIPROPILENE	POLYPROPYLENE	
	SCocca PER PANCA	Bench shell	112 €
	Trave 2 posti	2 seater beam	40 €
	Trave 3 posti	3 seater beam	52 €
	Trave 4 posti	4 seater beam	66 €
	Trave 5 posti (3gambe)	5 seater beam (3legs)	78 €
	Gamba alluminio 1pz	Aluminium leg 1pc	108 €
	Plano appoggio nero	Black table	72 €

Accessori		F	G	S	Top	Extra	Fiesta	Nuvola	
KISDRIV	Sedile imbottito rivestito	Seat Padded	54 €	57 €	69 €	71 €	80 €	105 €	115 €

POLIPROPILENE | Polypropylene | Polypropylène / KIRE



KIRE SOFT

VERSIONE PANCA - BENCH

SCocca RIVESTITA

FULLY UPHOLSTERED SHELL

	VERSIONE RIVESTITA	FULLY UPHOLSTERED	F*	G	S	Top*	Extra	CUOIO
	SCocca PER PANCA	Bench shell	294 €	298 €	310 €	329 €	351 €	450 €
			* Non disponibile in PLANET e IKON					
	Trave 2 posti	2 seater beam				40 €		
	Trave 3 posti	3 seater beam				52 €		
	Trave 4 posti	4 seater beam				66 €		
	Trave 5 posti (3gambe)	5 seater beam (3legs)				78 €		
	Gamba alluminio 1pz	Aluminium leg 1pc				108 €		
	Plano appoggio nero	Black table				72 €		