

office space



Distributor pro ČR a SK
www.mintiga.cz
obchod@mintiga.cz
+420 724 124 042

Diemme.

1

furniture to
connect people

Lavoriamo dove siamo nati

We work where we were born | Nous travaillons où nous sommes nés

4

Comfort e Sostenibilità

Comfort and Sustainability | Confort et Durabilité

6

Collezioni

Collections | Les Collections

9

Rivestimenti

Upholstery | Nuanciers

169

LAVORIAMO
DOVE
SIAMO NATI

WE WORK
WHERE
WE WERE
BORN

NOUS
TRAVAILLONS
OÙ NOUS
SOMMES NÉS

Non abbiamo mai inaugurato ufficialmente Diemme, sarebbe come dire: “Missione compiuta... lavoro terminato... possiamo rilassarci”.

Finirebbe per intorpidirci, quando invece per noi Diemme è un progetto in continua evoluzione, su cui riversare la nostra dedizione ogni giorno. Dopo più di vent’anni di attività ci sentiamo a casa.

Ci siamo conosciuti nel 1985. Entrambi lavoravamo nel settore dell’imbottito, ma in due aziende diverse. Poi siamo diventati colleghi. Nel corso del tempo si è creato tra noi un rapporto di profondo rispetto e amicizia, indispensabile per intraprendere un’attività insieme. Nel 1995 in una giornata fredda d’inverno, dopo una delle nostre lunghe chiacchierate, abbiamo deciso di unire le forze e dar vita a Diemme.

L’azienda nasce lavorando per conto di terzi, ma la nostra visione è sempre stata quella di dedicarci alla creazione di un sistema coerente di sedute tutte nostre. Dopo aver disegnato e realizzato con passione la nostra prima seduta da ufficio, è stato chiaro che quella era la strada da seguire. In poco tempo è uscito il nostro primo catalogo, a cui hanno fatto seguito i primi successi. Come dimenticare la nostra prima fiera. Sono passati molti anni, ma il ricordo di vedere i nostri prodotti introdotti nel mondo office rimane indelebile.

Come tutti, anche noi abbiamo attraversato gli anni della crisi, ma siamo ugualmente cresciuti grazie a scelte coraggiose e ben precise: collaborare con architetti e designer, e ampliare la visione del mondo office affiancando divani e poltroncine alle sedute che già producevamo.

La forza di Diemme è ciò che ci circonda: il territorio in cui siamo nati e in cui ancora operiamo, i nostri partner locali, le persone che ci sono sempre state vicino. Grazie a loro abbiamo trovato il coraggio di guardare lontano, affrontare nuovi progetti, aprirci a nuovi mercati.

Siamo rimasti umili e concreti, ma allo stesso tempo ambiziosi di trasformare le nostre collezioni in un sistema di prodotti versatili e adatti ad ogni ambiente. Forse può sembrare un luogo comune, ma due menti sono davvero meglio di una. Esperienze diverse, punti di vista diversi, personalità diverse; Diemme è cresciuta come azienda perché ci siamo sempre impegnati a vedere oltre alle nostre differenze e a trovare un punto d’unione. Questo è il nostro pensiero.

We have never officially inaugurated Diemme, it would be like saying: “Mission accomplished... job done... time to relax”. It would end up numbing us, when instead, to our way of thinking, Diemme is a project in continuous evolution, which we smother with our dedication every day. After more than twenty years of activity, we feel at home.

We met in 1985, we both worked in the upholstery trade, but in two different companies. Then we became colleagues. Over time, a relationship of deep respect and friendship developed between us, essential for embarking on any joint venture. On a cold winter’s day in 1995, after one of our long chats, we decided to join forces and give life to Diemme.

At first, Diemme worked for third parties, but our vision was always to dedicate ourselves to creating a coherent seating system all our own. After designing and creating our first office chair with passion, it was clear that this was the way forward. In a short time our first catalogue was released, followed by the first successes. How can we forget our first fair. Many years have passed, but the memory of seeing our products introduced into the office world remains indelible.

Like everyone else, we too have gone through the years of crisis, but we have equally grown thanks to courageous and precise choices: collaborating with architects and designers, and widening the vision of the office world by introducing sofas and armchairs alongside the seating we already produced. The strength of Diemme is what surrounds us: the territory in which we were born and where we still operate, our local partners, the people who have always been close to us. Thanks to them, we found the courage to look far, face new projects, open up to new markets. Though remaining humble and concrete, we are at the same time ambitious to transform our collections into a system of versatile products suited to any environment. It may sound like a cliché, but two heads really are better than one. Different experiences, different points of view, different personalities; Diemme has grown as a company because we have always been committed to seeing beyond our differences and finding a meeting point. This is the way we see it.

Nous n’avons jamais officiellement inauguré Diemme, ce serait comme dire: “Mission accomplie... travail terminé... on peut se détendre”. Cela finirait par nous engourdir, alors qu’au contraire pour nous Diemme est un projet en évolution continue, sur lequel verser notre dévouement quotidien. Après plus de vingt ans d’activité, nous nous sentons chez nous.

Nous nous sommes rencontrés en 1985, nous travaillions tous les deux dans le secteur du rembourrage, mais dans deux entreprises différentes. Ensuite, nous sommes devenus collègues. Au fil du temps, une relation de profond respect et d’amitié s’est nouée entre nous, indispensable pour entreprendre ensemble une entreprise. En 1995, par une froide journée d’hiver, après l’une de nos longues conversations, nous avons décidé d’unir nos forces et de donner vie à Diemme.

L’entreprise a été fondée en travaillant pour des autres sociétés, mais notre vision a toujours été de créer un système cohérent de sièges qui nous est propre. Après avoir conçu et créé notre premier siège de bureau avec passion, il était clair que c’était la voie à suivre. En peu de temps, notre premier catalogue est sorti, suivi des premiers succès. Comment oublier notre première foire. De nombreuses années ont passé, mais la mémoire de voir nos produits introduits dans le monde du bureau reste indélébile.

Comme tout le monde, nous avons aussi traversé les années de la crise, mais nous nous sommes également développés grâce à des choix courageux et précis: collaborer avec les architectes et les designers, élargir la vision du monde du bureau en plaçant canapés et fauteuils à côté des sièges que nous avons déjà produits. La force de Diemme, c’est ce qui nous entoure: le territoire dans lequel nous sommes nés et dans lequel nous opérons encore, nos partenaires locaux, les gens qui ont toujours été proches de nous. Grâce à eux, nous avons trouvé le courage de regarder loin, de faire face à de nouveaux projets, de nous ouvrir à de nouveaux marchés. Nous sommes restés humbles et concrets, mais en même temps ambitieux de transformer nos collections dans un système de produits polyvalents adaptés à tout environnement. Cela peut sembler banal, mais deux esprits valent vraiment mieux qu’un. Différentes expériences, différents points de vue, différentes personnalités; Diemme a grandi parce que nous nous sommes toujours engagés à voir au-delà de nos différences et à trouver un point de rencontre. Telle est notre pensée.

COMFORT E SOSTENIBILITÀ

L'innovazione vera e propria permette di soddisfare le esigenze sia attuali che future.

Siamo chiamati ad affrontare le sfide quotidiane con atteggiamento reattivo e propositivo, andando alla ricerca di nuove soluzioni creative senza soffermarci per inerzia su procedimenti obsoleti. Gli spazi entro cui ci muoviamo devono, quindi, plasmarsi su di noi perché si crei una sinergia tra pensiero ed espressione, interiorità ed esteriorità. Non dovremmo percepire alcuna dissonanza tra il nostro desiderio di crescere e la qualità dell'ambiente che ci circonda.

Ogni giorno ci mettiamo in gioco per facilitare e migliorare la vita di altre persone. Proprio per questa ragione, lo spazio intorno a noi non deve adattarsi solo alle nostre esigenze correnti ma anche ai bisogni delle generazioni future.

Scegliere una seduta che garantisce un supporto corretto è un modo semplice e diretto di migliorare la qualità del tempo e favorire il benessere. Per garantire questo servizio, eseguiamo controlli in tutte le fasi di produzione seguendo un sistema di gestione della qualità certificato ISO 9001. Oltre a offrire il giusto supporto ergonomico, proponiamo ampie possibilità di personalizzazione per rispondere al bisogno umano, sempre sentito, di unicità e bellezza.

Ci assicuriamo che tutti i materiali che utilizziamo siano di origine locale per ridurre gli sprechi e favorire quindi la crescita di un mercato "verde". In fase di progettazione, cerchiamo i percorsi migliori per realizzare prodotti a ridotto impatto ambientale lungo l'intero ciclo di vita. Grazie a queste accortezze, semplici ma significative, due delle nostre sedute hanno ottenuto la certificazione promossa dal Green Public Procurement, ovvero il nuovo approccio Europeo agli acquisti ecosostenibili.

COMFORT AND SUSTAINABILITY

True innovation should meet both current and future needs.

We are called to face daily challenges with a reactive and proactive attitude, going in search of new creative solutions without dwelling on inertia on obsolete procedures. The spaces in which we move must, therefore, mold themselves around us to create a synergy between thought and expression, interior and exterior. We should not perceive any friction between our desire to grow and the quality of the environment around us.

Every day we roll our sleeves up to facilitate and improve the lives of other people. Precisely for this reason, the space around us ought not only to adapt to our current needs but also to those of future generations.

Choosing a chair that guarantees correct support is a simple and direct way of improving the quality of time and promoting well-being. To ensure this, we carry out checks at all stages of production following an ISO 9001 certified quality management system. In addition to offering the right ergonomic support, we offer extensive customization options to respond to the ever-present human hunger for uniqueness and beauty.

We make sure that all the materials we use are of local origin to reduce waste and therefore encourage the growth of a "green" market. During the design phase, we look for the best ways to create products with reduced environmental impact throughout their entire life cycle. Thanks to these simple but significant precautions, some Diemme chairs have obtained Green Public Procurement certification, being the new European approach to eco-sustainable purchases.

CONFORT ET DURABILITÉ

L'innovation actuelle nous permet de répondre aux besoins actuels et futurs.

Nous sommes appelés à faire face aux défis quotidiens avec une attitude réactive et proactive, à la recherche de nouvelles solutions créatives sans insister sur les procédures obsolètes. Les espaces dans lesquels nous évoluons doivent donc se modeler sur nous afin de créer une synergie entre pensée et expression, intériorité et extériorité. Nous ne devons percevoir aucune dissonance entre notre envie de grandir et la qualité de l'environnement qui nous entoure.

Chaque jour, nous nous impliquons pour faciliter et améliorer la vie des autres. C'est précisément pour cette raison que l'espace qui nous entoure doit non seulement s'adapter à nos besoins actuels mais aussi aux besoins des générations futures.

Choisir un siège qui garantit un soutien correct est un moyen simple et direct d'améliorer la qualité du temps et de favoriser le bien-être. Pour garantir ce service, nous effectuons des contrôles à toutes les étapes de la production selon un système de gestion de la qualité certifiée ISO 9001. En plus d'offrir le bon support ergonomique, nous proposons de nombreuses options de personnalisation pour répondre au besoin humain d'unicité et de beauté.

Nous prenons garde à tous les matériaux que nous utilisons qu'ils soient d'origine locale pour réduire les déchets et donc favoriser la croissance d'un marché «vert». Pendant la phase de conception, nous recherchons les meilleures façons de créer des produits à impact environnemental réduit tout au long du cycle de vie. Grâce à ces précautions simples mais importantes, certains de nos sièges ont obtenu la certification promue par Green Public Procurement, qui est la nouvelle approche européenne pour les achats éco-durables.

OFFICE SPACE



VELVET

15



HALFPIPE

25



ARTÙ

33

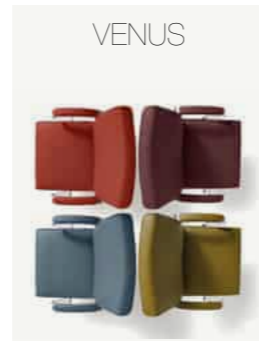

VENUS

41

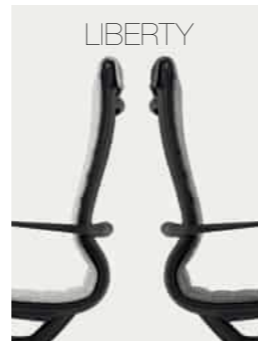

LIBERTY

51

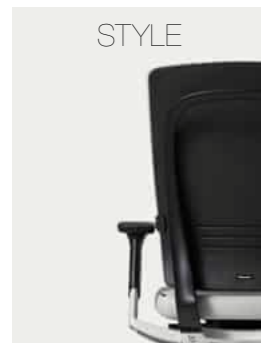

STYLE

61



AUCKLAND

69



DUKE

79



LEAD

91



FIT

101



GOAL

113

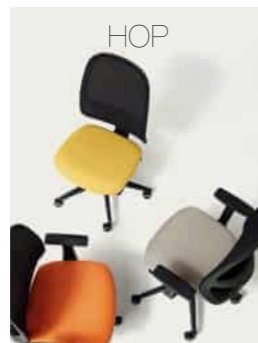

HOP

123



FIVE

131



BINGO

141

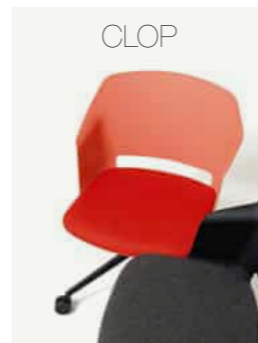

CLOP

151



OBLÒ

163

Collezioni
Collections | Les collections

Il design è un processo creativo che nasce da un'esigenza collettiva concreta. Negli ultimi anni si è evoluto il modo in cui utilizziamo gli ambienti lavorativi; le esigenze a cui il design è chiamato a rispondere sono quindi cambiate. Ci siamo liberati da una rigidità mentale che penalizzava il mondo office, organizzato per compartimenti stagni, con strutture predefinite che rendevano difficile la condivisione. Emerge così la necessità di creare ambienti flessibili, aperti, che favoriscano gli scambi e le interazioni; ambienti che promuovano un'atmosfera di serenità, in cui la comunicazione con l'altro non sia solo necessaria ma anche soddisfacente. Siamo consapevoli che la qualità dello spazio in cui ci troviamo influisce su ogni cosa, dalla salute al lavoro, dalla creatività alla collaborazione. Le sedute Diemme sono diverse per forma e funzione, ma nella loro specificità lavorano insieme per dare vita a uno spazio unico e innovativo.

OFFICE SPACE



“Siamo consapevoli che la qualità dello spazio in cui ci troviamo influisce su ogni cosa, dalla salute al lavoro, dalla creatività alla collaborazione.”



Design is a creative process that arises from a concrete collective need. Over the last few years, the way we use working environments has evolved; therefore the ways in which designers have been commissioned have also had to change. We freed ourselves from that mental rigidity that used to penalize the office world, organized by watertight compartments, with pre-defined structures that made sharing difficult. Thus emerges the need to create flexible, open workspaces that favour exchanges and interaction; spaces that promote an atmosphere of serenity, in which communication with others is not only necessary but also satisfying. We are aware that the quality of the space we are in affects everything from health to work, from creativity to collaboration. Diemme chairs are different in shape and function, but in their own specific way they combine to create a unique and innovative workspace.

Le design est un processus créatif né d'un besoin collectif concret. Ces dernières années, la façon d'utiliser les environnements de travail a évolué; les besoins auxquels le design est appelé à répondre ont donc changés. Nous nous sommes libérés d'une rigidité mentale qui pénalisait le monde du bureau, organisé par des compartiments fermés, avec des structures prédéfinies qui rendaient le partage difficile. Ainsi émerge la nécessité de créer des environnements flexibles et ouverts qui favorisent les échanges et les interactions; des environnements qui favorisent une atmosphère de sérénité, dans laquelle la communication avec l'autre est non seulement nécessaire mais également satisfaisante. Nous sommes conscients que la qualité de l'espace dans lequel nous nous trouvons affecte tout, de la santé au travail, de la créativité à la collaboration.

“Design e progettazione
si aprono a nuove prospettive
su ciò che può essere
uno spazio dedicato all’ufficio,
dove le persone si possono
sentire comode e libere,
proprio come a casa loro.
Creare lo spazio di lavoro del futuro
attraverso il design e il comfort
è parte della nostra filosofia.”

Direzionali

Executive chairs | Chaises exécutives

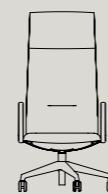

VELVET

15



HALFPIPE

25



ARTÙ

33



VENUS

41

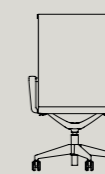

LIBERTY

51

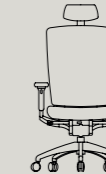

STYLE

61



AUCKLAND

69



DUKE

79

“Design and planning open up new perspectives on what an office space can be, where people can feel comfortable and free, just like at home. Creating the workspace of the future through design and comfort is part of our philosophy.”

“Le Design et la planification s’ouvrent à de nouvelles perspectives sur ce qui peut être un espace de bureau, où les gens peuvent se sentir à l’aise et libres, comme à la maison. Créer l’espace de travail du futur grâce au design et au confort fait partie de notre philosophie.”

Disegnata da Giorgio Topan,
VELVET è una famiglia versatile e sinuosa.
Trova espressione della sua identità
nella linea del fianco e nella ricchezza
di dettagli personalizzabili.
È leggera e sottile ma comunque
confortevole grazie alla seduta
ad alta densità.
Velvet offre due opzioni per il bracciolo:
in alluminio, adatta ad ambienti
dal gusto contemporaneo,
e completamente imbottita, per inserirla
con distinzione in contesti più tradizionali.

VELVET

Arch. Giorgio Topan / 2018

15

VELVET

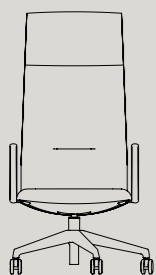

Designed by Giorgio Topan, VELVET is a versatile and slinky family that expresses its identity through its fine profile lines and its wealth of customizable details. It is light and slimline but still comfortable thanks to its high density seat. Velvet offers two armrest options: aluminium, suitable for environments with a contemporary feel; and fully padded, which fit with distinction into more traditional settings.

Conçu par Giorgio Topan, VELVET est une famille polyvalente et sinieuse qui trouve l'expression de son identité dans la ligne d'un côté et dans la richesse des détails personnalisables. Il est léger et fin mais toujours confortable grâce à son assise haute densité. Velvet offre deux options d'accoudoir: en aluminium, adapté aux environnements avec un goût contemporain, ou entièrement rembourré, qui s'inscrit avec distinction dans des contextes plus traditionnels.



Velvet executive chair / Ikon 330 - 130 - 430 - 230

VELVET



Velvet executive chair / Ikon 1230

VELVET



VELVET

Arch. Giorgio Topan / 2018

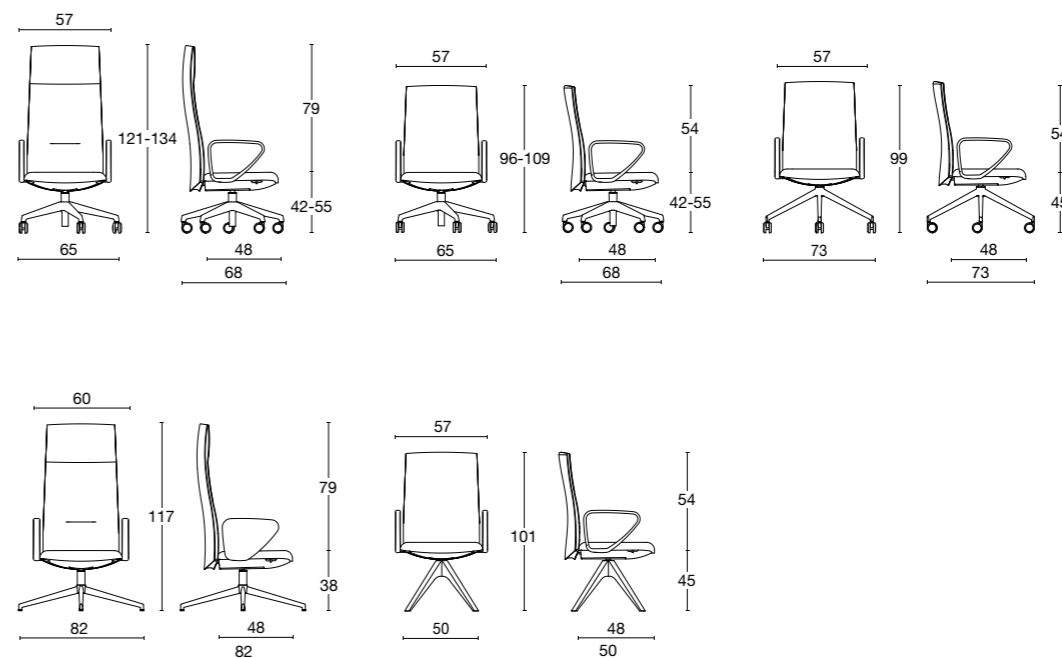

Ideale per uffici di alta direzione e manageriali e per importanti sale riunioni. Schienale caratterizzato da un dettaglio di design nella parte laterale che può essere evidenziato tappezzandolo di un altro colore. Sedile dotato di meccanismo syncron autopesante a scomparsa. Braccioli fissi in alluminio lucido, verniciati neri o imbottiti e rivestiti. Base a 5 razze in alluminio pressofuso lucido su ruote gommata e autofrenanti. Versione visitatore / riunione, con schienale medio, basamento a 4 razze su ruote o piedini, in alluminio lucido o laccato nero, a 5 razze in alluminio lucido, o su 4 gambe in legno di frassino. Versione lounge con base 4 razze in alluminio laccato nero con pouf.

Perfect for executive offices and imposing boardrooms. The back has a profile design detail which can be upholstered in a contrasting colour. The seat is in polypropylene with a completely hidden snazzy syncro self-adjustment mechanism. The fixed arms are in polished aluminium or black lacquered, or again padded and upholstered. The polished aluminium five-spur base has self-braking castors. For the visitor-cum-meeting version, the back is medium-height and there is a choice of: four-spur polished aluminium or black lacquered base on glides or castors; or a five-spur polished aluminium base; with four wooden legs in ashwood. The lounge version has a four-spur black lacquered aluminium base and is accompanied by a footstool.

Idéal pour les bureaux de direction et pour les importantes salles de réunions. Le dossier est caractérisé par un détail de conception sur le côté qui peut être mis en évidence en le recouvrant d'une autre couleur. L'assise est équipée d'un mécanisme syncron auto-régulant selon le poids de l'utilisateur. Les accoudoirs sont fixes en aluminium poli, peints en noir ou rembourrés et recouverts. La base 5 étoiles en aluminium poli sur roulettes en caoutchouc et auto-freînées, pour la version visiteur / réunion, le dossier est moyen et la base peut être à 4 branches sur roulettes ou pieds, toujours en aluminium poli ou laqué noir, avec 5 rayons en aluminium poli, ou même sur 4 pieds en frêne. Enfin également disponible en version lounge, sur piètement aluminium 4 étoiles laqué noir avec pouf.



struttura
poliuretano rigido e polipropilene



base / alluminio / alluminio verniciato nero / legno di frassino



rivestimento
tessuto



pelle
ecopelle

frame

rigid toughened polyurethane and polypropylene

base: / alluminio / black lacquered aluminium / ashwood

upholstery

fabric

genuine leather
faux leather

structure

polyuréthane rigide et polypropylène

base / aluminium / aluminium peint en noir / bois de frêne

revêtement

tissu

cuir
simili cuir

Disegnata da DorigoDesign,
la linea di sedute direzionali **HALFPIPE**
si compone di due differenti schienali
combinati con basi, finiture
e rivestimenti diversi.

Grazie alla sua versatilità è adatta
a tutti gli spazi dedicati all'ufficio,
e le morbide imbottiture offrono
un maggiore comfort.

Le versioni a schienale basso
si ambientano elegantemente
in zone d'incontro. Disponibili
su base a 5 razze in alluminio,
su telaio 4 lame con meccanismo
di ritorno, o ancora su telaio slitta.

HALFPIPE

DorigoDesign / 2013

25

HALFPIPE

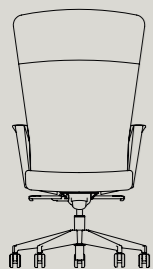

From DorigoDesign, the HALFPIPE line of executive seating consists of two different backrests combined with various bases, finishes and coverings. Thanks to its versatility, Halfpipe is suitable for all types of office areas. The plush padding offers even greater comfort. The low-backed versions sit elegantly in meeting areas; available on a 5-spur aluminum base, on a 4-blade frame with return mechanism, or on a sled base.

Conçue par DorigoDesign, la gamme de sièges de direction HALFPIPE se compose de deux dossiers différents combinés avec des bases, des finitions et des revêtements différents. Halfpipe, grâce à sa polyvalence, convient à tous les espaces dédiés au bureau. Le rembourrage doux offre encore plus de confort. Les versions à dossier bas sont élégamment installées dans les zones de réunion; disponible sur piètement aluminium 5 branches, sur piètement 4 lames avec mécanisme de retour ou sur piètement luge.



HALFPIPE

DorigoDesign / 2013



Halfpipe executive chair / Polo 850 - 930

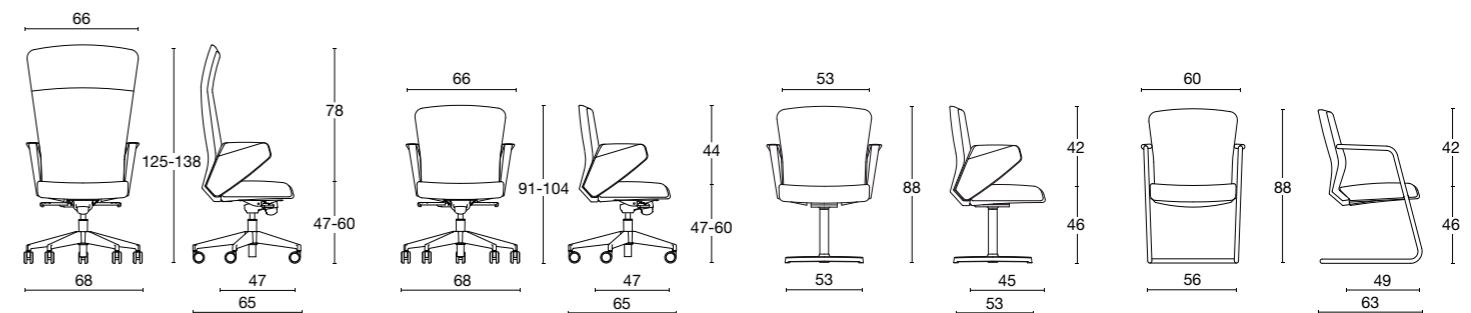

La poltrona presidenziale è dotata di un meccanismo sincronizzato bloccabile in diverse posizione, con regolazione d'intensità in base al peso. La versione meeting e visitatore presenta uno schienale basso, è disponibile su base a 5 razze in alluminio su ruote gommata e autofrenanti oppure su telaio 4 lame con meccanismo di ritorno in posizione. Due varianti di bracciolo: imbottito per una variante più classica o in alluminio lucidato. La versione slitta presenta la struttura cromata con braccioli integrati.

The executive armchair has a synchron mechanism which assures gaslift regulation and backrest tilt, lockable in various positions. The meeting and visitor chair has a medium-height back and comes either on a five-spur aluminium base on castors, or on a four-blade base with with swivel and return mechanism. Two kind of armrests are available: upholstered for a classic version, or in polished aluminium. The cantilever frame is chromed with fixed arms.

Le fauteuil présidentiel se équipé d'un mécanisme synchronisé réglable en plusieurs position, avec réglage de l'intensité en fonction du poids corporel. La version réunion et visiteur a un dossier bas, il est disponible sur une base 5 étoiles en aluminium sur roulettes caoutchoutées et autofreinées ou sur piétement 4 branches avec mécanisme de retour en position. Deux variantes d'accoudoirs: rembourrés pour une variante plus classique ou en aluminium poli. La version traîneau a une structure chromée avec accoudoirs intégrés.



struttura
acciaio e multistrato di faggio



base alluminio lucido / cromata



rivestimento
tessuto



pelle
ecopelle

frame

steel and beech plywood

base: polished aluminium / chromed

upholstery

fabric

genuine leather
faux leather

structure

acier et contreplaqué de hêtre

base en aluminium poli / chromé

revêtement

tissu

cuir
simili cuir

ARTÙ è la seduta ideale
per ambienti di lavoro attenti
all'eleganza e al rigore formale.
Dettagli e finiture sono ai massimi livelli.
La preziosa trapuntatura della seduta
si integra con una linea ricca e raffinata
per un insieme esteticamente accattivante
e tecnologicamente avanzato.
Il meccanismo knee-tilt
permette allo schienale di oscillare
e bloccarsi in diverse posizioni.
L'ergonomia è garantita
dalla regolazione di tensione
in base al peso corporeo.

ARTÙ

Diemme Lab / 2015

33

ARTÙ

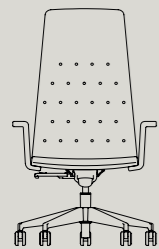

ARTÙ is the ideal chair for work environments requiring elegance and formality. Its details and finishes are top quality, the stylish quilting integrates with richly refined lines, creating an aesthetically appealing and technologically advanced whole. The knee-tilt mechanism allows the backrest to tilt and also lock in different positions. Ergonomics are guaranteed by tension regulation based on body weight.

ARTÙ est le siège idéal pour les environnements de travail élégants et avec une rigueur formelle. Les détails et les finitions sont au plus haut niveau, le précieux matelassage du dossier s'intègre à une ligne riche et raffinée, créant un ensemble esthétiquement attrayant et technologiquement avancé. Le mécanisme d'inclinaison permet au dossier de se bloquer dans différentes positions. L'ergonomie est garantie par la régulation de la tension en fonction du poids corporel.





Artù executive chair / Polo 838 / Cube 2026 - Jet 9110 / Gorgeous 2140

ARTÙ



ARTÙ

Diemme Lab / 2015

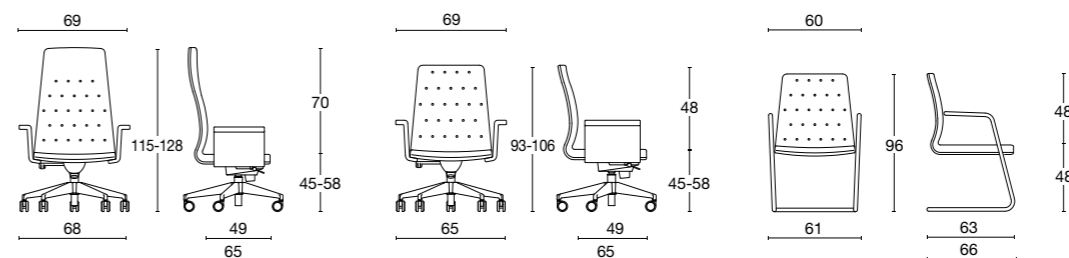

Sedia direzionale e presidenziale, con scocca in multistrato di faggio e imbottitura in poliuretano espanso. Meccanismo alzata a gas o knee-tilt bloccabile in più posizioni, con regolatore di tensione in base al peso corporeo, meccanismo antishock ed elevazione a gas. Base a 5 razze in alluminio su ruote gommata e autofrenanti. Braccioli fissi imbottiti e rivestiti. Disponibile anche in versione visitatore su slitta cromata con braccioli fissi cromati.

Executive and manager's chair with beech ply shell and polyurethane foam. With gaslift; or with a knee-tilt mechanism which allows the back to be locked in different positions, weight adjustment, anti-shock system as well as gaslift. 5-spur polished aluminium base on self-braking rubber castors. Fixed upholstered arms. Available also as a visitor chair on chromed cantilever frame with fixed arms.

Chaise exécutive et présidentielle, avec coque en contreplaqué de hêtre et rembourrage en mousse de polyuréthane. Mécanisme avec élévation à gaz ou knee-tilt oscillant avec réglage dans plusieurs positions, avec régulateur de tension en fonction du poids de l'utilisateur, mécanisme antichoc et élévation de gaz. Base 5 étoiles en aluminium sur roulettes caoutchoutées et auto-freinées. Accoudoirs fixes rembourrés et revêtus. Aussi disponible en version visiteur sur piètement luge chromé avec accoudoirs fixes chromés.



struttura
multistrato di faggio



base alluminio / cromata



rivestimento
tessuto



pelle
ecopelle

frame

beech plywood

base: polished aluminium / chromed

upholstery

fabric

genuine leather
faux leather

structure

contreplaqué de hêtre

base en aluminium / chrome

revêtement

tissu

cuir
simili cuir

VENUS, elegante e contemporanea, caratterizza lo spazio con il suo design leggero ed essenziale.

Le sedute Venus sono ideali per spazi professionali, ma il loro stile si adatta a qualsiasi tipo di soluzione per la working area.

La versione visitatore, con struttura in tubolare di acciaio cromato, unisce design e funzionalità e offre la possibilità di ottimizzare gli spazi impilando le sedute una sull'altra.

VENUS

Diemme Lab / 2008

41

VENUS

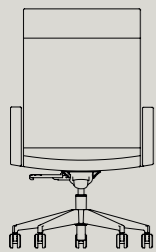

VENUS, elegant and contemporary, characterizes any space with its light and essential design. Venus chairs are ideal for professional spaces, but their style conveys a contemporary idea of the working area suitable for all kinds of requirements. The space-savily stackable visitor version, on a chromed tube cantilever base, combines design and functionality.

VENUS, élégant et contemporain, caractérise l'espace avec son design léger et essentiel. Les chaises Venus sont idéales pour les espaces professionnels, mais leur style communique une idée contemporaine de l'espace de travail adapté à toute solution. La version visiteur, avec piètement luge en acier chromé, allie design et fonctionnalité en offrant la possibilité d'optimiser les espaces en empilant les sièges l'un sur l'autre.

VENUS



Venus executive chair / Polo 827 - 930

VENUS



Venus executive chair / Polo 881

VENUS

Diemme Lab / 2008



Venus executive chair / Polo 832

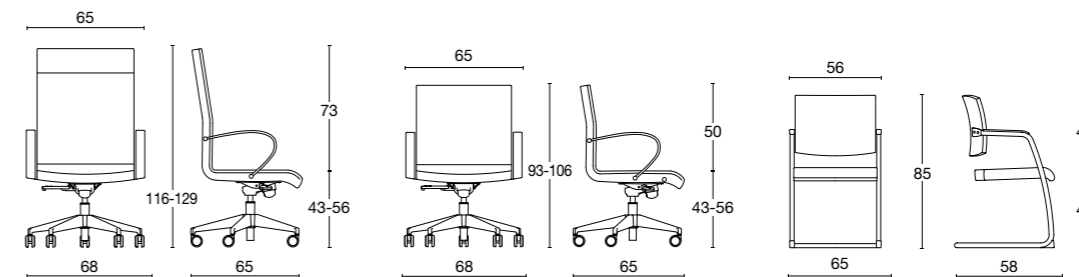

Sedia direzionale e presidenziale, con scocca in multistrato di faggio e imbottitura in poliuretano espanso. Meccanismo knee-tilt bloccabile in più posizioni, con regolatore di tensione in base al peso corporeo, meccanismo antishock ed elevazione a gas. La versione con schienale basso è disponibile anche con sola alzata a gas. Base a 5 razze in alluminio su ruote gommata e autofrenanti. Braccioli fissi cromati, imbottiti e rivestiti. Disponibile anche in versione visitatore su slitta cromata con braccioli fissi integrati, impilabile.

Executive armchair, with beech ply shell and polyurethane foam. Tilt mechanism lockable in different positions, with weight adjustment, antishock system and gaslift. 5-spur polished aluminium base on self-braking rubber castors. Fixed chromed arms, with padding and upholstery. Available as a stackable visitor chair on chromed cantilever frame with fixed arms.

Chaise exécutive et présidentielle, avec coque en contreplaqué de hêtre et rembourrage en mousse de polyuréthane. Mécanisme d'inclinaison knee-tilt réglable en positions multiples, avec régulateur de tension en fonction du poids corporel, mécanisme antichoc et élévation gaz. La version avec dossier bas est également disponible avec vérin à gaz uniquement. Base 5 étoiles en aluminium sur roues caoutchoutées et auto-freînées. Accoudoirs fixes chromés, rembourrés et revêtus. Aussi disponible en version visiteur sur piètement luge.



struttura

multistrato di faggio / acciaio



base alluminio lucido / cromata



rivestimento

tessuto



pelle
ecopelle

frame

beech plywood / steel

base: polished aluminium / chromed

upholstery

fabric

genuine leather
faux leather

structure

contreplaqué de hêtre

base en aluminium / chrome

revêtement

tissu

cuir
simili cuir

Le linee compositive della seduta
LIBERTY sono moderne e leggere,
il suo design minimale.

Grazie alle sue curve sinuose,
Liberty combina un'estetica attraente
a componenti ergonomiche altamente
performanti.

Il meccanismo di oscillazione "balance"
e la rete indeformabile la rendono
adatta a un utilizzo prolungato
in qualsiasi spazio lavorativo.

LIBERTY

Diemme Lab / 2019

51

LIBERTY

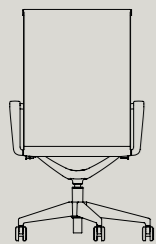

The modern and light compositional lines of LIBERTY make it a family with minimalist design. Liberty looks great with its sinuous seat curves and it boasts ergonomic high-performance components such as the balance swing mechanism and its non-deformable mesh. These features make it suitable for a prolonged sit in any work space.

Les lignes de LIBERTY, modernes et légères, donnent à cette famille des sièges un design minimaliste. Liberty combine une esthétique attrayante, grâce à ses courbes sinueuses, avec des composants ergonomiques et de hautes performances tels que le mécanisme "balance" et la résille indéformable. Ces caractéristiques permettent une assise prolongée dans n'importe quel espace de travail.



LIBERTY



Liberty executive chair / Blazer CUZ39 / Mesh NK-00

LIBERTY

Diemme Lab / 2019



Liberty executive chair / Blazer CUZ28

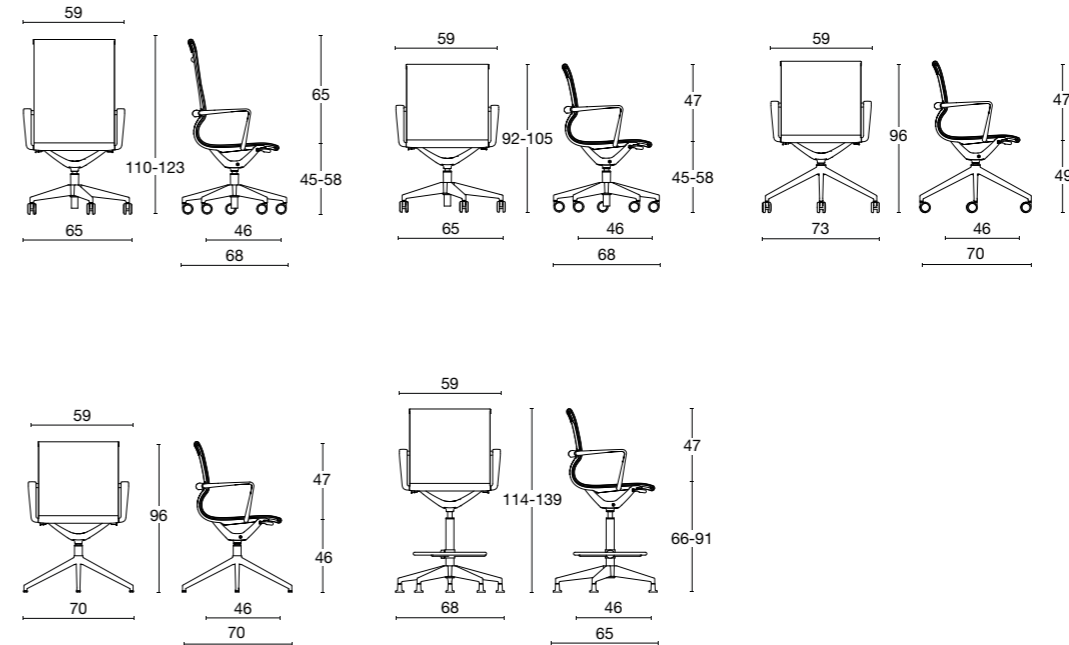

Sedia direzionale, caratterizzata da linee moderne e leggere. La struttura e i braccioli fissi sono in nylon nero. Completamente rivestita in rete indeformabile ed ergonomica e meccanismo di oscillazione "balance". Base a 5 razze di nylon nero o alluminio, con ruote gommata e autofrenanti, oppure come visitatore su base a 4 razze in alluminio verniciato nero o lucido, o ancora su sgabello operativo con appoggiapiedi. Optional: cuscinetto imbottito e tappezzato.

An executive armchair with light modern lines. The frame and arms are in black nylon. All in black or white ergonomic non-deformable mesh. Balance mechanism and gaslift. Five-spur black nylon black lacquered or polished aluminium base on self-braking rubber castors, or as visitor chair on four-spur black aluminium or polished base, or again as technical stool with footrest. Available also with an upholstered seat.

Fauteuil de direction, caractérisé par des lignes modernes et légères. Les accoudoirs fixes et la structure sont en nylon noir. Entièrement recouvert de résille non déformable et ergonomique disponible en noir et blanc. Elévation à gaz et mécanisme balance. Base 5 étoiles en nylon noir ou en aluminium, avec roulettes caoutchoutées et auto-freinées, ou visiteur sur piètement 4 branches pivotant en aluminium peint noir ou brillant, ou toujours sur tabouret avec repose-pieds. Optional: coussin rembourré et revêtu.



struttura
nylon



base nylon / alluminio lucido /
alluminio verniciato nero



rivestimento
tessuto / rete



pelle
ecopelle

frame
nylon

base: nylon / polished aluminium / black lacquered
aluminium

upholstery
fabric / mesh

genuine leather
faux leather

structure
nylon

base nylon / base en aluminium poli / aluminium peint noir

revêtement
tissu / résille

cuir
simili cuir

STYLE combina comfort ed ergonomia a un design fresco e dinamico.

Il meccanismo sincron, con traslatore e braccioli orientabili e regolabili, permette di trascorrere confortevoli ore davanti a una scrivania. Grazie a linee rigorose e ricchezza di particolari, le sedute Style si collocano sia in ambienti moderni sia in contesti tradizionali.

STYLE

Diemme Lab / 2009

61

STYLE

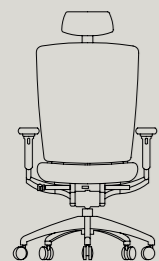

STYLE combines comfort, technology and ergonomics with a fresh and dynamic design. A synchron mechanism with translator and fully adjustable armrests allow you to spend comfortable hours at your desk. Thanks to their rigorous lines and luxurious details, Style chairs sit well in both modern and more traditional contexts.

STYLE allie confort, technologie et ergonomie avec un design frais et dynamique. Le mécanisme synchrone avec réglage d'assise en profondeur et réglages des accoudoirs vous permettent de passer des heures confortables devant un bureau. Grâce à leurs lignes rigoureuses et riches en détails, les sièges de direction Style sont placées à la fois dans des environnements modernes et dans des contextes traditionnels.





Style executive chair / Mirage 651 - 426 - 629

STYLE



STYLE

Diemme Lab / 2009

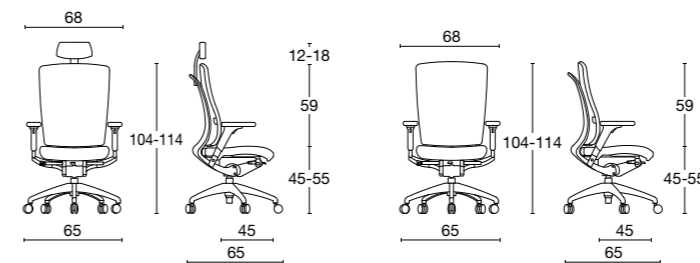

Seduta direzionale, con schienale ergonomico, dotato di supporto lombare regolabile in altezza, imbottita in schiumato a freddo, meccanismo sincrono con traslatore bloccabile in diverse posizioni, con regolatore di tensione in base al peso corporeo, meccanismo antishock e regolazione a gas, braccioli regolabili in altezza e orientabili in poliuretano morbido, e base a 5 razze in alluminio pressofuso lucido, su ruote. Disponibile la versione con appoggiatesta.

Executive armchair with cold foam padding and ergonomic backrest and adjustable lumbar support. With gaslift and anti-shock, the syncro mechanism with slide system locks in various positions through bodyweight adjustment. Fully adjustable armrests in soft polyurethane. Five-spur polished aluminium base on castors. Available also with headrest.

Siège exécutif, avec dossier ergonomique, équipé d'un support lombaire réglable en hauteur, rembourrage en mousse moulée à froid, mécanisme syncro avec blocage dans différentes positions, avec régulateur de tension basé sur le poids corporel, mécanisme anti-choc et réglage du gaz, accoudoirs réglables en hauteur et en direction latérale en polyuréthane souple et base à 5 branches en aluminium poli, sur roulettes. Version avec appuie-tête disponible.



struttura
nylon



base alluminio lucido



rivestimento
tessuto



pelle
ecopelle

frame
nylon

base: polished aluminium

upholstery
fabric

genuine leather
faux leather

structure
nylon

base en aluminium poli

revêtement
tissu

cuir
simili cuir

Raffinata, confortevole e versatile,
AUCKLAND è idonea a molti
ambienti lavorativi.

La tecnologia della rete lascia spazio
a una silhouette discreta,
leggera ed elegante.

La versione imbottita offre sostegno
e protezione per un maggiore comfort.

Lo schienale è disponibile in due altezze:
in profilo basso per sale riunioni
e conferenze, in profilo alto
per gli uffici operativi.

AUCKLAND

Diemme Lab / 2006

69

AUCKLAND

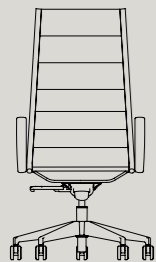

Refined, comfortable and versatile, AUCKLAND is perfectly suitable for multiple working environments. Its mesh technology makes for an elegantly light yet functional chair. The upholstered version assures even greater comfort with a choice of backrest heights for support and protection: the medium-back works well in meeting and conference rooms; whilst the high-back is for everyday workspaces. Designed to be both a task and executive chair.

Raffiné, confortable et polyvalent, AUCKLAND est parfaitement adapté à de multiples environnements de travail. La technologie de la résille laisse place à une silhouette discrète et élégante, légère et fonctionnelle. La version revêtue donne encore plus de confort avec un dossier à deux hauteurs, elle offre soutien et protection: avec dossier bas pour les salles de réunion et de conférence, et avec dossier haut pour les espaces de travail quotidiens. Conçu soit pour les bureaux opératives soit pour la direction.



AUCKLAND

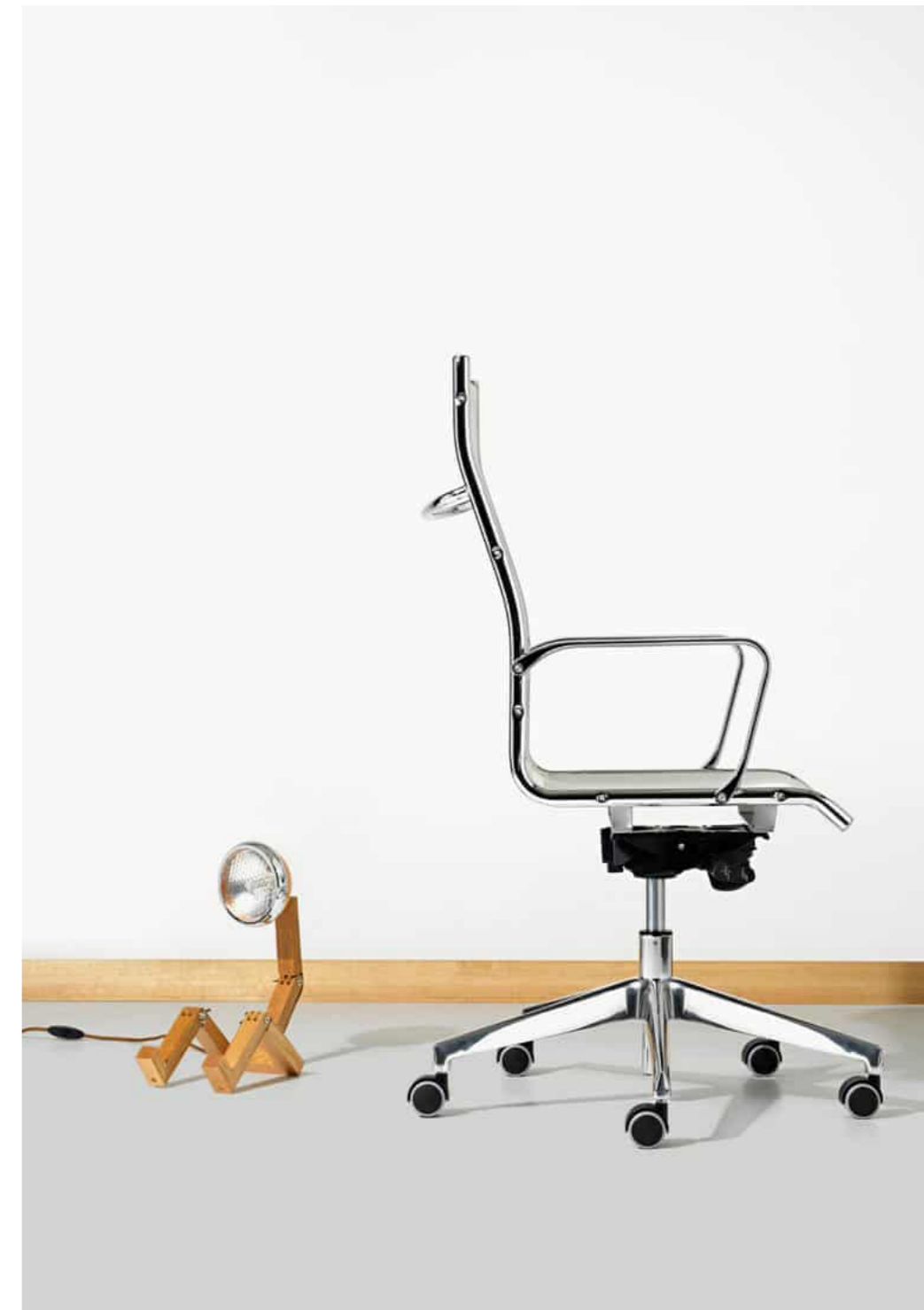

Auckland executive chair / Mesh FB0538

AUCKLAND

Diemme Lab / 2006



Auckland executive chair / Polo 881

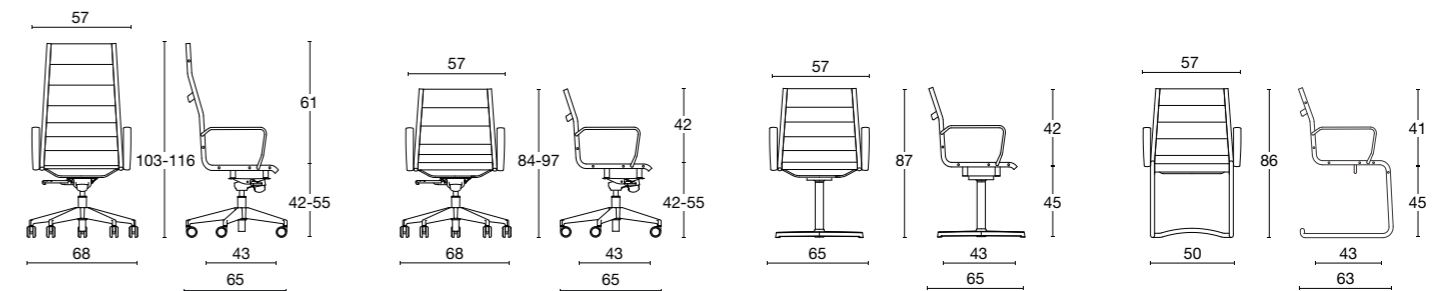

Poltrona presidenziale, direzionale e visitatore. Caratterizzata dallo schienale e sedile in rete nera, bianca o grigia o tutta imbottita e rivestita. Braccioli e base in alluminio su ruote gommata e autofrenanti, essere dotate di meccanismo knee-tilt che permette l'oscillazione dello schienale bloccabile in più posizioni. La versione con schienale basso è disponibile anche con sola elevazione gas, o su base slitta cromata o ancora su telaio 4 razze in alluminio con meccanismo di ritorno automatico in posizione.

Executive and managerial armchairs, and visitor chair, with medium or high back, all in black, white or grey mesh. Also available fully upholstered. Chromed steel frame, with polished aluminium armrests and five-spur base on self-braking rubber castors. Knee-tilt mechanism that allows the backrest to be locked in various positions. The medium-height back is optionally available with gaslift only; or on a chromed cantilever frame; or on four-spur polished aluminium base with swivel and return mechanism.

Fauteuil présidentiel, exécutif et visiteur. Caractérisé par dossier et assise en résille noire, blanche ou grise. Également disponible en version entièrement rembourrée et revetue. Accoudoirs et base en aluminium sur roulettes caoutchoutées et auto-freinées, équipée d'un mécanisme d'inclinaison knee-tilt qui permet l'oscillation du dossier, peut être bloqué dans plusieurs positions. La version à dossier bas est également disponible en solo vérin à gaz, sur piètement luge chromé ou sur piètement 4 branches en aluminium avec mécanisme de retour automatique en position.



struttura
acciaio cromato



base alluminio lucido / cromata



rivestimento
tessuto / rete



pelle
ecopelle

frame

chromed steel

base: polished aluminium / chromed

upholstery

fabric / mesh

genuine leather
faux leather

structure

acier chromé

base en aluminium poli / chromé

revêtement

tissu / résille

cuir
simili cuir

Linee e volumi trovano un perfetto equilibrio ergonomico e visivo nella seduta operativa **DUKE**.
I braccioli e l'appoggiatesta, integrati alla silhouette, formano un'elegante linea continua.
Le finiture garantiscono il massimo comfort e donano alla seduta un aspetto ricercato.

DUKE

Diemme Lab / 2012

79

DUKE

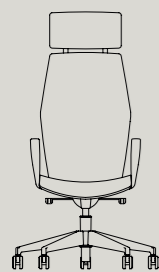

Lines and volumes find perfect ergonomic and visual balance in the DUKE task chair. Its arms and headrest blend in elegantly and smoothly. The finishes of the back and armrests guarantee maximum comfort and, at the same time, give this chair a stylish look.

Les lignes et les volumes trouvent un parfait équilibre ergonomique et visuel dans le siège de direction DUKE. Les accoudoirs et l'appui-tête sont intégrés à la silhouette dans une ligne continue et élégante. Les finitions des dossiers et des accoudoirs garantissent un maximum confort et, en même temps, confèrent au siège une apparence raffinée.



Duke executive chair / Cube 2004 - 2026 - 2007

DUKE



Duke executive chair / Cube 2026

DUKE

Diemme Lab / 2012



Duke executive chair / Cube 2004

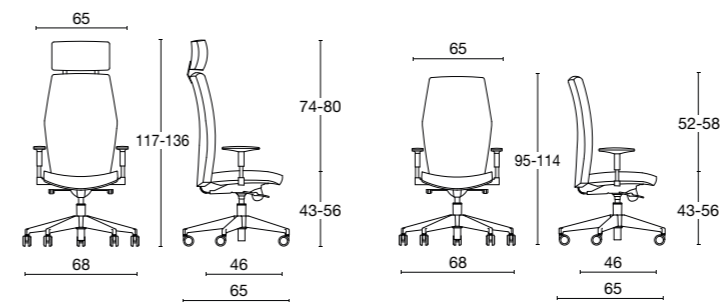

Poltrona direzionale, con schienale medio o con appoggiatesta, caratterizzata dalle linee eleganti e dal massimo comfort. Scocca in multistrato di faggio, imbottita in poliuretano espanso. Meccanismo sincron, bloccabile in diverse posizioni, dotato di regolatore di tensione in base al peso corporeo, meccanismo antishock e regolazione a gas. Base 5 razze in nylon nero o in alluminio, su ruote autofrenanti e gommata. Optional: braccioli in polipropilene fissi bianchi o neri, regolabili 1d oppure ancora regolabili 3d.

An elegant and extremely comfortable executive armchair with a choice of backs: medium height; or high with headrest. Seat and back in beech plywood and polyurethane foam. Syncro mechanism lockable in five positions, with tension adjustment according to user bodyweight, anti-shock mechanism, and gaslift. Five-spur black nylon or polished aluminium on self-braking rubber castors. Optional: fixed white or black armrests; these can also be 1d or 3d adjustable.

Fauteuil de direction, avec dossier moyen ou avec appui-tête, caractérisé par des lignes élégantes et un confort maximum. Structure d'assise et dossier contreplaqué de hêtre, rembourré de mousse de polyuréthane. Mécanisme synchron, réglable dans différentes positions, équipé d'un régulateur de tension basé sur le poids corporel, le mécanisme anti-choc et la régulation du gaz. Base 5 étoiles en nylon noir ou aluminium, sur roulettes auto-freinées et caoutchoutées. En option: accoudoirs fixes en polypropylène blanc ou noir, réglables 1d ou 3d.



struttura

multistrato di faggio



base nylon / alluminio lucido



rivestimento

tessuto



pelle
ecopelle

frame

beech plywood

base: nylon / polished aluminium

upholstery

fabric

genuine leather
faux leather

structure

contreplaqué de hêtre

base nylon / aluminium

revêtement

tissu

cuir
simili cuir

“Incoraggiare la produttività attraverso il design è il primo passo per creare l’ambiente di lavoro del futuro. La nostra filosofia è progettare spazi di design che, a fine giornata, facciano sentire le persone comode e libere, proprio come a casa loro.”

Operative

Task chairs | Sièges de bureau

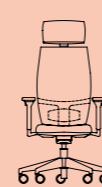

LEAD

91

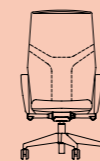

FIT

101

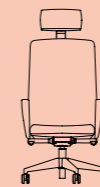

GOAL

113



HOP

123



FIVE

131

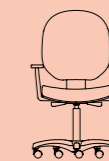

BINGO

141



CLOP

151

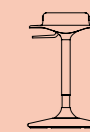

OBLÒ

163

“Where space can encourage productivity through design: this is precisely where the workspaces of the future can be created. We try to create a balance between our design philosophy and the creation of spaces which make people feel comfortable, in a welcoming place, and free, just like at home.”

“Là où l'espace peut encourager productivité grâce à la conception: c'est précisément là qu'il se crée l'espace de travail du futur. Nous essayons de créer un équilibre entre notre philosophie de design et la création d'espaces qui, à la fin de la journée, font que les personnes se sentent à l'aise dans un lieu confortable, et libre, comme à la maison.”

Proporzioni equilibrate e dinamicità formali contraddistinguono il design delle sedute **LEAD**. Lo schienale, disponibile in rete o completamente rivestito, influisce significativamente sull'impatto visivo della seduta, permettendole di adattarsi a diverse tipologie di arredo. Lead offre un'ampia serie di elementi opzionali, tra cui l'appoggiatesta e il supporto lombare regolabile.

LEAD

Diemme Lab / 2018

91

LEAD

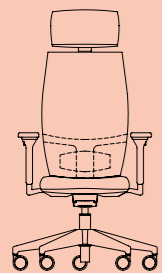

Balanced proportions and formal dynamism distinguish the design of the LEAD chair. The mesh or fully upholstered backs make for a striking visual impact and enable LEAD to blend in to all manner of settings. The wide range of optionals includes a headrest, and height and depth-adjustable lumbar support.

Proportions et dynamisme équilibrés distinguent le design de LEAD. Le dossier, en résille ou entièrement revêtu, affecte de manière significative sur l'impact visuel du siège et lui permet de s'adapter aux types d'ameublement très différents. Lead propose une large gamme d'éléments en option, y compris l'appui-tête et soutien lombaire réglable en hauteur et en profondeur.



Lead task chair / Mesh 8043 - Wolin 7050.22 / Wolin 7050.03 / Mesh 3029 - Wolin 7050.36

LEAD



Lead task chair / Mesh 8043 - Wolin 7050.22

LEAD

Diemme Lab / 2018



Lead task chair / Wolin 7050.03

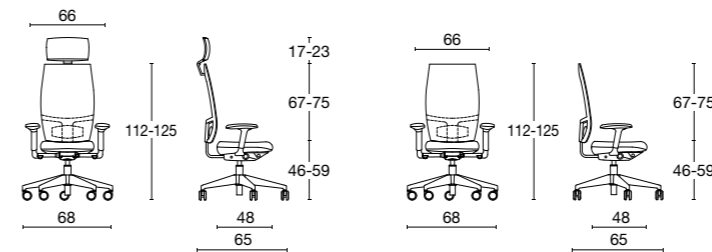

Poltrona operativa, caratterizzata dalla struttura in polipropilene antracite, schienale in rete (6 colori disponibili) oppure completamente rivestito, regolabile in altezza. Sedile in poliuretano espanso ad alta densità, rivestito. Meccanismo sincron, con elevazione a gas e regolazione dello schienale in 5 diverse posizioni, dotato di meccanismo antishock e regolatore di tensione in base al peso corporeo dell'utilizzatore. Base a 5 razze di nylon antracite con ruote gommata e autofrenanti. Optional: supporto lombare regolabile in altezza e profondità; appoggiatesta in rete o imbottito; base alluminio; braccioli fissi o regolabili 1d (altezza) 2d (altezza e profondità) 3d (altezza, profondità e orientabili); traslatore; ruote forate.

A height-adjustable task chair characterized by its dark grey polypropylene frame, with its backrest either in a choice of 6 mesh colours, or fully upholstered. The upholstered seat has high density polyurethane foam. A synchron mechanism assures gaslift regulation and backrest tilt, lockable in five positions, with anti-shock mechanism and bodyweight adjustment. 5-spur dark grey nylon base with self-braking rubber castors. Optional features: height and depth-adjustable lumbar support; mesh or padded headrest; polished aluminium base; slide system to adjust seat depth; castors with holes. In addition, a choice of four armrest types: fixed; height adjustable (1d); height and depth adjustable (2d); height and depth adjustable with rotation (3d).

Siège de bureau, caractérisée par la structure en polypropylène anthracite, dossier résille (6 coloris disponible), ou entièrement revêtu, réglable en hauteur. Assise en mousse de polyuréthane haute densité, rembourrée et revêtue. Mécanisme Synchrone, avec vérin à gaz et réglage du dossier dans 5 positions différentes, équipé d'un mécanisme régulateur de tension basé sur le poids corporel de l'utilisateur. Base 5 branches en nylon anthracite avec roulettes caoutchoutées et auto-freinées. En option: support lombaire réglable en hauteur et en profondeur; appui-tête en résille ou rembourré; base en aluminium; accoudoirs fixes ou réglable 1d (hauteur) 2d (hauteur et profondeur) 3d (hauteur, profondeur et pivotant); translation d'assise; roulettes ouvertes.



struttura
nylon



base nylon antracite / alluminio lucido



rivestimento
tessuto / rete



pelle
ecopelle

frame
nylon

base: anthracite nylon / polished aluminium

upholstery
fabric / mesh

genuine leather
faux leather

structure
nylon

base nylon anthracite / aluminium poli

revêtement
tissu / résille

cuir
simili cuir

Le sedute **FIT** si distinguono per l'elegante sagomatura e la contrapposizione tra l'imbottitura del sedile e lo schienale. Lo schienale di FIT MESH è rivestito in rete; quello di FIT UP, dal design originale, è in tessuto termoformato; quello di FIT POLY è in polipropilene e fibra di vetro. Grazie alla loro trasversalità, queste sedute conferiscono agli ambienti un valore aggiunto di eleganza e modernità.

FIT

Diemme Lab / 2015

101

FIT

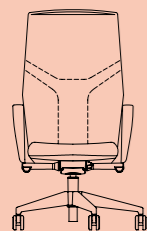

All FIT chairs are united by their elegant shape and the contrast between their padded seat and back. The FIT MESH backrest; the original design of the FIT UP thermoformed fabric backrest; the FIT POLY backrest in fibreglass and polypropylene. Their transversality allows these chairs to fit well into different settings, bringing an added touch of modern elegance.

Tous les sièges de la famille FIT sont unis par la forme élégante du dossier et par le contraste entre le rembourrage de l'assise et les différents types de dossier. Le dossier de FIT MESH est en résille noir ou blanche; celle de FIT UP, avec un design original, est en tissu thermoformé; celle de FIT POLY est en polypropylène et fibre de verre. Grâce à leur transversalité, ces sièges harmonisent facilement dans différents environnements en ajoutant une valeur d'élégance et modernité.



FIT



Fit Mesh task chair / Mesh FB0538 - Jet 3036 - 6091 - Jet 9110



Fit Mesh task chair / Mesh FB0538 - Jet 3036

FIT



Fit Up | Poly | Mesh task chair / Bingo 651 / Jet 9804 / Mesh FN0538 - Jet 9281



Fit Up task chair / Bingo 651



Fit Poly task chair / Jet 9804



FIT

FIT

Diemme Lab / 2015

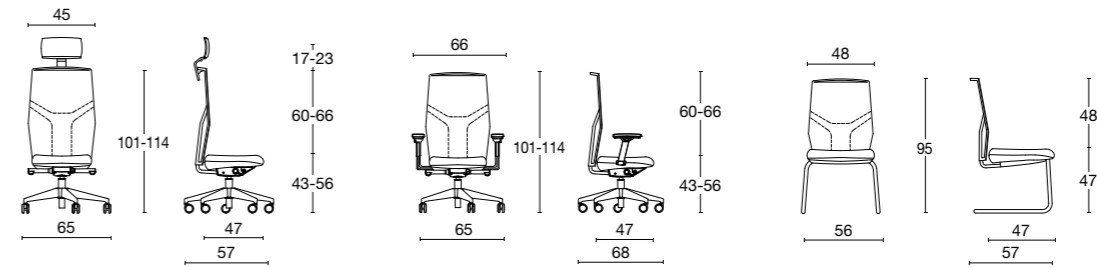

Sedia operativa, schienale in rete bianca o nera o in polipropilene bianco o nero o rivestito in materiale termoformato, regolabile in altezza con lama up&down cromata, con supporto lombare integrato. Sedile imbottito in poliuretano espanso elastico e completamente rivestito. Meccanismo sincron, con elevazione a gas e regolazione dello schienale in 5 diverse posizioni, dotato di meccanismo antishock e regolatore di tensione in base al peso corporeo dell'utilizzatore. Base a 5 razze in nylon bianca o nera o in alluminio, su ruote gommata. Braccioli bianchi o neri sia fissi che regolabili 1d (altezza) o braccioli neri 3d (altezza, profondità e orientabili). Optional: appoggiatesta, traslatore, ruote forate.

A task chair with a choice of backrests: black or white mesh; black or white polypropylene; completely upholstered in thermoformed fabric. Height adjustable in height with chromed movement integrated lumbar support. Fully upholstered seat with elastic polyurethane foam. Its synchron mechanism assures gaslift regulation and backrest tilt, lockable in five positions, with anti-shock mechanism and bodyweight adjustment. Base in black or white nylon, or polished aluminium. Three armrest types: fixed; height adjustable (1d); height and depth adjustable with rotation (3d). Optional features: headrest, slide system to adjust the seat depth, castors with holes.

Siège de bureau, dossier en résille blanche ou noire ou en polypropylène blanc ou noir ou recouvert d'un tissu thermoformé, réglable en hauteur avec lame chromée, avec support lombaire intégré en sa forme. Assise rembourrée en mousse de polyuréthane et complètement revêtue. Mécanisme Synchrone, avec élévation gaz et régulation de le dossier dans 5 positions différentes, équipé d'un mécanisme régulateur de tension basé sur le poids corporel de l'utilisateur. Base à 5 rayons en nylon ou aluminium blanc ou noir, sur roulettes. Accoudoir blanc ou noir, fixe et réglable 1d (hauteur) ou noir accoudoirs 3d (hauteur, profondeur et réglable). En option: appui-tête, translation d'assise, roulettes ouvertes.

pCon
PLANIFFER



struttura
nylon



base nylon nero / nylon bianco / alluminio lucido



rivestimento
tessuto / rete



pelle
ecopelle

frame
nylon

base: black nylon / white nylon / polished aluminium

upholstery
fabric / mesh

genuine leather
faux leather

structure
nylon

base nylon noir / nylon blanc / aluminium poli

revêtement
tissu / résille

cuir
simili cuir

GOAL è il protagonista incontrastato degli ambienti anticonformisti. Grazie ai materiali e alle tecniche di lavorazione, Goal ha ottenuto la certificazione Europea CAM per il basso impatto ambientale. Design raffinato e meccanismi innovativi permettono a Goal di reinventarsi per ogni occasione.

GOAL

Diemme Lab / 2014

113

GOAL

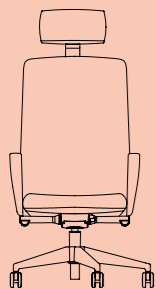

GOAL is the incomparable solution for non-conformist settings. Thanks to its modern materials and efficient manufacturing techniques, Goal has been awarded the European CAM certification which guarantees its low environmental impact. Its refined design and clever mechanisms allow Goal to reinvent itself from time to time, to adapt to each and every occasion in the most appropriate way possible.

GOAL est le modèle protagoniste des environnements non-conformistes. Grâce à des matériaux modernes et techniques de traitement efficace, il a obtenu la certification européenne CAM Critères environnementaux selon la loi italienne. Le design raffiné et les mécanismes innovants permettent à Goal de se réinventer et s'adapter à l'occasion de la manière la plus appropriée possible.



GOAL



Goal task chair / Mesh 8033 - Wolin 7050.36



GOAL

GOAL

Diemme Lab / 2014

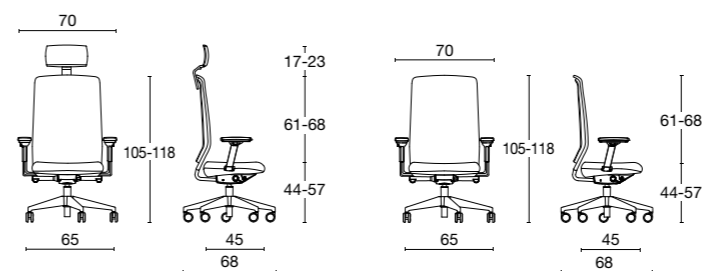

Seduta operativa con schienale alto, struttura in polipropilene nera. Schienale in rete, disponibile in 6 colori, o imbottito e rivestito, con supporto lombare regolabile, sedile imbottito in poliuretano espanso. Meccanismo sincron, con elevazione a gas e regolazione dello schienale in 5 diverse posizioni, dotato di meccanismo antishock e regolatore di tensione in base al peso corporeo dell'utilizzatore. Braccioli fissi in polipropilene neri, o regolabili regolabili 1d (altezza) o 3d (altezza, profondità, orientabili). Base a 5 razze in nylon nero o in alluminio pressofuso lucido, su ruote gommata e autofrenanti. Optional: appoggiatesta, traslatore.

Task chair with high backrest and black polypropylene frame. Backrest in choice of 6 mesh colours, upholstered, and with adjustable lumbar support; upholstered seat. The synchron mechanism assures gaslift regulation backrest tilt, lockable in five positions, with anti-shock mechanism and bodyweight adjustment. Three armrest types: fixed; height adjustable (1d); height and depth adjustable with rotation (3d). 5-spur black nylon or polished base, with rubber self-braking castors. Optional features: headrest, slide system to adjust seat depth.

Siège de bureau, dossier en résille disponible en 6 couleurs différentes, avec soutien lombaire réglable en hauteur. Assise en mousse de polyuréthane haute densité, revêtue. Mécanisme minisyncron, avec élévation gaz et réglage du dossier dans 4 positions différentes, équipé d'un mécanisme régulateur de tension basé sur le poids corporel utilisateur et anti-choc. Base 5 branches en nylon noir avec roulettes en caoutchouc et frein. En option: base en aluminium; accoudoirs fixes ou réglables 1D (uniquement en hauteur) ou 3d (hauteur, profondeur et pivotant), appui-tête, translation d'assise.



struttura
polipropilene e nylon



base nylon nero / alluminio lucido



rivestimento
tessuto / rete



pelle
ecopelle

frame

polypropylene and nylon

base: black nylon / polished aluminium

upholstery

fabric / mesh

genuine leather
faux leather

structure

polypropylène et nylon

base nylon noir / aluminium poli

revêtement

tissu / résille

cuir
simili cuir

HOP è una seduta operativa di ultima generazione. La sua struttura ergonomica è studiata per favorire una corretta postura a chi ne fa un uso intensivo. Hop consente una regolazione precisa grazie al meccanismo minisincron e al solido supporto lombare. Il suo design è robusto, ma lo schienale in rete le dona una distinta leggerezza visiva.

HOP
Diemme Lab / 2018

123

HOP

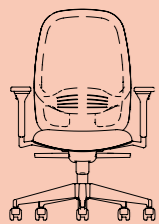

HOP is a latest generation task chair. Its ergonomic frame has been studied to assure correct posture and excellent performance when used extensively. Hop features a solid lumbar support and a mini-synchron mechanism which allows precise adjustment. Hop has a sturdy design but retains a distinctly light look thanks to its mesh backrest.

HOP est une siége de bureau de la dernière génération. Sa structure ergonomique est conçue pour favoriser posture correcte et assurer une excellente performance à ceux qui l'utilisent intensivement. Hop a un solide support lombaire et un mécanisme minisynchron qui permet le réglage en différentes positions. C'est un siége au design robuste, mais il garde un caractère de légèreté visuelle grâce à son dossier en résille.



HOP

Diemme Lab / 2018



Hop task chair / Mesh 8033 - Era CSE01

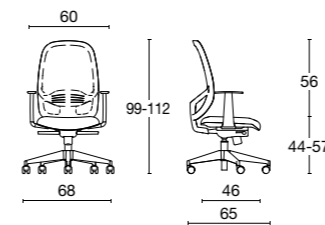

Poltrona operativa, schienale in rete disponibile in 6 colori diversi, con supporto lombare regolabile in altezza. Sedile in poliuretano espanso ad alta densità, rivestito. Meccanismo mini sincron, con elevazione a gas e regolazione dello schienale in 4 diverse posizioni, dotato di meccanismo antishock e regolatore di tensione in base al peso corporeo dell'utilizzatore. Base a 5 razze di nylon nero con ruote gommata e autofrenanti. Optional: base alluminio; braccioli fissi o regolabili 1D (solo in altezza) o 3d (altezza, profondità e orientabili).

Task chair with mesh back available in a choice of six colours, lumbar support and height adjustment. Upholstered seat with high density polyurethane foam. Mini-synchron mechanism with 2 levers, one for the gaslift and one for backrest tilt, lockable in 4 positions, with anti-shock mechanism and bodyweight adjustment lever. 5-spur black nylon base on rubber self-braking castors. Optional features: polished aluminium base. Three armrest types: fixed; height adjustable (1d); height and depth adjustable with rotation (3d).

Siège de bureau, dossier en résille disponible en 6 couleurs différentes, avec soutien lombaire réglable en hauteur. Assise en mousse de polyuréthane haute densité, revêtue. Mécanisme minisyncron, avec élévation gaz et réglage du dossier dans 4 positions différentes, équipé d'un mécanisme régulateur de tension basé sur le poids corporel utilisateur et anti-choc. Base 5 branches en nylon noir avec roulettes en caoutchouc et frein. En option: base en aluminium; accoudoirs 1D fixes ou réglables (uniquement en hauteur) ou 3d (hauteur, profondeur et pivotant).



struttura
nylon



base nylon nero / alluminio lucido



rivestimento
tessuto / rete



pelle
ecopelle

frame
nylon

base: nylon nero / alluminio lucido

upholstery
fabric / net

genuine leather
faux leather

structure
nylon

base nylon noir / aluminium poli

revêtement
tissu / résille

cuir
simili cuir

FIVE è una famiglia di sedute operative all'avanguardia per comfort ed efficienza. Progettata per un utilizzo giornaliero continuativo, è disponibile in diverse varianti adatte ad ogni utilizzo. Lo schienale robusto è proposto in versione alta e bassa. Il design di Five è semplice ed essenziale, le sue finiture raffinate.

FIVE

Diemme Lab / 2011

131

FIVE

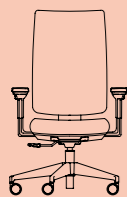

FIVE is a family of task chairs highlighting comfort and efficiency. It is specially designed for continuous daily use and it is available in several variants that maximize its performance in any context. Five's design is simple and essential, with stylish finishing. The high and medium-height sturdy backrests allow Five to fit into any type of setting.

FIVE est une famille de sièges de bureau à la pointe de la technologie et du confort. Il est spécialement conçu pour une utilisation quotidienne continue et il est disponible en plusieurs variantes pour maximiser ses performances dans n'importe quel contexte. Le design de Five est simple et essentiel, ses finitions raffinées. Le dossier robuste, proposé en version haute et basse, permet à Five de s'adapter à tout type d'environnement.



Five task chair / Era CSE01 - CSE14 - CSE11 - CSE13 - CSE19

FIVE



Five task chair / Era CSE01 - CSE19

FIVE

FIVE

Diemme Lab / 2011

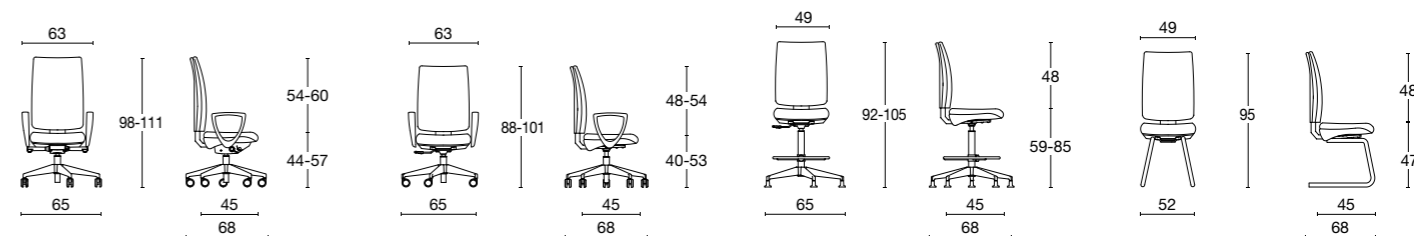

Sedia operativa, sedile e schienale in polipropilene nero, imbottitura in poliuretano espanso ad alta densità ed elastico. Supporto lombare integrato e regolabile in altezza grazie alla lama up&down. Meccanismo mini synron, con elevazione a gas e regolazione dello schienale in 4 diverse posizioni, dotato di meccanismo antishock e regolatore di tensione in base al peso corporeo dell'utilizzatore. Base a 5 razze in nylon nero o in alluminio pressofuso lucido, su ruotegommata e auto frenanti. I braccioli sono fissi in polipropilene neri, regolabili 1d oppure 3d (altezza, profondità e orientabili). È disponibile la versione sgabello tecnico con poggiatesta cromato e la versione visitatore con telaio slitta verniciato nero.

Task chair with seat and back in black polypropylene with high density elastic polyurethane foam. Integrated and height adjustable lumbar support. Mini-synron mechanism with gaslift and backrest tilt, lockable in 4 positions, with anti-shock mechanism and bodyweight adjustment. 5-spur black nylon or polished die-cast aluminium base on rubber self-braking castors. Three armrest types: fixed; height adjustable (1d); height and depth adjustable with rotation (3d). Also available: a lab stool with chromed footrest; and a visitor chair on black lacquered cantilever frame.

Siège de bureau, assise et dossier avec structure en polypropylène noir, rembourré en mousse de polyuréthane élastique. Le mécanisme est mini-synron avec 2 leviers, pour régler le vérin à gaz et un pour oscillation de dossier, réglable en 4 positions, avec mécanisme anti-choc et système de régulation de la tension. La base est disponible en nylon noir ou en aluminium poli avec caoutchouc et castors auto-freinés. Accoudoirs fixe noir en polypropylène ou réglables en hauteur ou réglables en 3d (hauteur, profondeur et pivotant). Le tabouret de laboratoire à le repose-pieds chromé et la chaise visiteur est disponible avec un piètement luge peint noir.



struttura
polipropilene



base nylon nero / alluminio lucido



rivestimento
tessuto



pelle
ecopelle

frame

polypropylene

base: black nylon / polished aluminium

upholstery

fabric

genuine leather
faux leather

structure

polypropylène

piètement en nylon noir / aluminium poli

revêtement

tissu

cuir
simili cuir

BINGO è disegnata per soddisfare esigenze funzionali e di immagine nella sempre più esigente working area. Il regolatore di tensione, basato sul peso corporeo dell'utilizzatore, rende Bingo una scelta pratica ed elastica. Un guscio rilassante è inserito in un impianto solido e resistente, riunendo così nel concetto di "elegante funzionalità" le caratteristiche visive e strutturali della seduta.

BINGO

Diemme Lab / 2015

141

BINGO

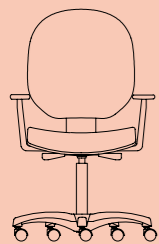

BINGO is designed to fulfil both functional and aesthetic requirements in the increasingly demanding workplace. The tilt mechanism works according to user bodyweight and makes Bingo a practical and flexible choice. A relaxing shell is incorporated into a tough, heavy-duty frame, thereby combining within the concept of elegant functionality both the chair's visual and structural features.

BINGO est conçu pour satisfaire les besoins fonctionnels et l'image de plus en plus exigeante aussi dans les espaces de travail. Le régulateur de tension, qui fonctionne en fonction du poids corporel de l'utilisateur, fait du Bingo un choix pratique et élastique. Une coque relaxante est insérée dans une structure solide et résistante, réunissant élégance et fonctionnalité.



BINGO



Bingo task chair / Blazer CUZ28 - CUZ82

BINGO

Diemme Lab / 2015



Bingo task chair / Blazer CUZ28

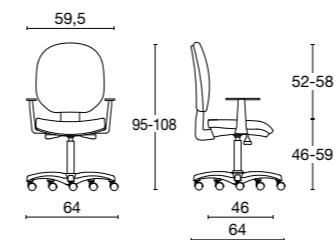

Sedia operativa, sedile e schienale in polipropilene nero o grigio, imbottitura in poliuretano espanso ad alta densità. Supporto lombare integrato e regolabile in altezza grazie alla lama up&down. Meccanismo mini-sincron, con elevazione a gas e regolazione dello schienale in 4 diverse posizioni, dotato di meccanismo antishock e regolatore di tensione in base al peso corporeo dell'utilizzatore. Base a 5 razze in nylon nero o grigio o in alluminio pressofuso lucido, su ruote gommata e auto frenanti. I braccioli sono fissi in polipropilene neri o grigi, oppure regolabili in 1d (altezza) neri o grigi o 3d neri (altezza, profondità e orientabili).

Task chair with seat and back in grey or black polypropylene structure, upholstered with high density polyurethane foam. The mechanism is mini-synchron, with 2 levers, one for the gaslift regulation and one for the backrest tilt, lockable in 4 positions, with antishock mechanism and weight adjustment lever. The base is available in black or grey nylon, or in polished aluminium with rubber and self-braking castors. Fixed black or grey arms in polypropylene or adjustable 1d black or grey (height) or 3d black (height, depth, rotation).

Siège de bureau, assise et dossier en polypropylène noir ou gris, rembourrage en mousse de polyuréthane haute densité. Support lombaire intégré et réglable en hauteur grâce à la lame. Mécanisme mini-synchron, avec vérin à gaz et réglage du dossier en 4 différentes positions, équipées de mécanisme anti-choc et régulateur tension basée sur le poids corporel de l'utilisateur. Base 5 branches en nylon noir ou gris ou en aluminium poli, sur roulettes en caoutchouc. Les accoudoirs sont fixés en polypropylène noir ou gris, ou réglable en 1d (hauteur) noir ou gris ou 3d noir (hauteur, profondeur et pivotant).



struttura

polipropilene



base nylon nero / nylon grigio / alluminio lucido



rivestimento

tessuto



pelle
ecopelle

frame

polypropylene

base: black nylon / grey nylon / polished aluminium

upholstery

fabric

genuine leather
faux leather

structure

polypropylène

base nylon noir / nylon gris / aluminium poli

revêtement

tissu

cuir
simili cuir

Disegnata da DorigoDesign,
CLOP si contraddistingue per
linee leggere e avvolgenti.
Il suo design vintage si combina
a un'attitudine contemporanea
al servizio della fruibilità
e dell'ergonomia.
La ricca gamma di personalizzazioni
le permette un inserimento
in molteplici ambienti.

CLOP

DorigoDesign / 2018

151

CLOP

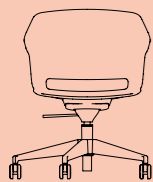

Thanks to its rich possibilities of customization CLOP fits easily into any setting, from waiting rooms to offices. Designed by DorigoDesign, Clop is distinguished by its slender lines and enveloping feel. Its vintage design combines with a contemporary attitude to make Clop a handy and ergonomic choice.

Grâce à ses riches possibilités de personnalisation CLOP s'intègre facilement dans n'importe quel environnement, des salles d'attente aux bureaux. Conçu par DorigoDesign, Clop se démarque par ses lignes légères et une sensation enveloppante. Son design vintage se combine à une attitude contemporaine qui met Clop au service de la convivialité et l'ergonomie.



Clop task chair / Blazer CUZ30 - CUZ28 - CUZ39 - CUZ08

CLOP



Clop task chair / Blazer CUZ39 - CUZ28 - CUZ08 / Bianco

CLOP

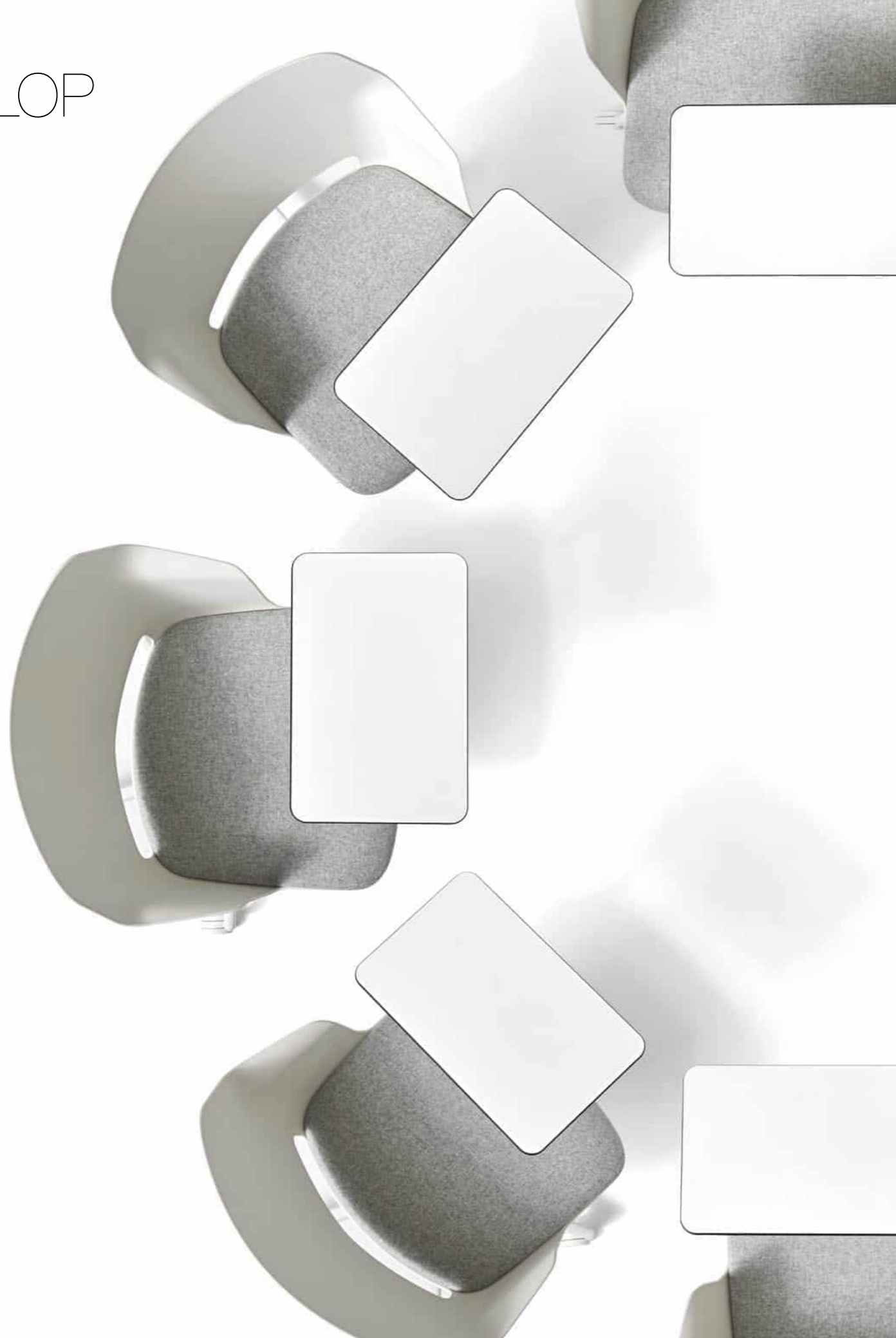

Clop task chair / Blazer CUZ28

CLOP

DorigoDesign / 2018



Clop task chair / Blazer CUZ30

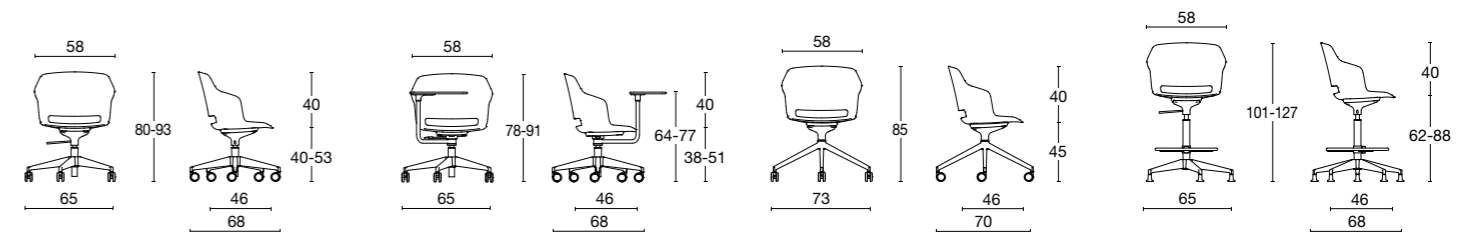

Poltroncina con scocca in polipropilene rinforzato, con possibilità di sedile imbottito e rivestito, schienale rivestito con supporto lombare regolabile per un utilizzo operativo, oppure ancora completamente rivestita. Disponibile su base 5 razze in polipropilene nero o bianco, o alluminio, con semplice elevazione a gas, o meccanismo oscillante libero o knee-tilt. La versione con tavoletta in Hpl girevole è perfetta per sale conferenze, riunioni e per il mondo scolastico. Per una versione meeting la base è in alluminio lucido, o verniciato nero o bianco su 4 razze con ruote. La versione sgabello tecnico adatta ai tavoli alti o laboratori è dotata di un appoggipiedi cromato. La gamma CLOP è molto ampia e presenta anche diversi telai fissi, cromati o verniciati, in legno, versione panca e sgabello da bar (vedere sezione Comunità e Attesa).

An armchair with an innovative design and clean lines, the polypropylene shell is available in different colours. It can be completely upholstered, or fitted with just a seat cushion. The range includes the fixed version on a black, white or chromed four-legged or sled frame, or on 4 legs in ashwood. The swivel version comes: on pyramid base in a choice of base finishes; black or white polypropylene; or in black, white or polished aluminum on castors. It is also available in a stool version for breakout areas, with a fixed chromed base, or a round base with gas lift. The family also includes the version with mechanism (see task seating section), or on beam, or with writing tablet (see contract section).

Fauteuil avec coque en polypropylène renforcé, avec possibilité d'assise rembourré et revêtue, coussin dossier disponible revêtue et avec de soutien lombaire réglable pour une utilisation opérative, ou coque complètement revêtue. Disponible sur base 5 branches en noir ou blanc en polypropylène ou en aluminium, avec élévation à gaz ou mécanisme oscillant libre ou inclinaison knee-tilt. La version avec tablette tournant en HPL est parfaite pour les salles de conférences, réunions et pour le monde scolaire. Pour une version réunion la base est en aluminium poli, ou peinte en noir ou blanc sur 4 rayons avec roulettes. La version tabouret technique s'adapte aux tables hautes ou laboratoires et elle est équipée d'un repose-pieds chromé. La gamme CLOP est très large et elle dispose également de plusieurs piètement fixes, chromés ou peints, en bois, version poutre, tabouret (voir la section Visiteur et Chaises).



struttura

polipropilene



base in nylon bianco / nylon nero / alluminio lucido / alluminio verniciato nero / alluminio verniciato bianco



rivestimento

tessuto



pelle
ecopelle

frame

polypropylene

base: chromed / black lacquered / white lacquered / polished aluminum / black polypropylene / white polypropylene

upholstery

fabric

genuine leather
eco-leather

structure

polypropylène

base en nylon blanc / nylon noir / aluminium poli / aluminium peint noir ou blanc

revêtement

tissu

cuir
simili cuir

Lo sgabello **OBLÒ**
è un'alternativa inedita ed
efficiente alla classica seduta da ufficio.
Il sedile ergonomico dona completa
libertà di movimento.
La sofisticata base svolge la funzione
di perno per l'oscillazione.
La dinamicità di Oblò permette
di mantenersi in attività
anche quando si è seduti
di fronte a una scrivania.

OBLÒ

Diemme Lab / 2018

163

OBLÒ

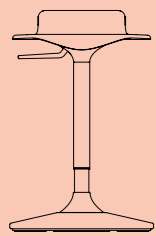

The OBLÒ stool is an unprecedented yet efficient alternative to the classic office chair. Its ergonomic seat has complete freedom of movement while the clean and sophisticated base remains still and acts as the pivot for the swing. The dynamic nature of Oblò allows the user to keep her or himself in swing with the body, as well as with the mind, when seated at a desk.

Le tabouret OBLÒ est une alternative originale et efficace au siège de bureau classique. L'assise oscillant donne complet liberté de mouvement. Le dynamisme d'Oblò permet de rester actif même quand on est assis devant un bureau.

OBLÒ

OBLÒ

Diemme Lab / 2018

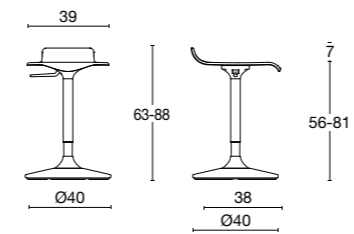

Sgabello innovativo multiuso, ideale per la seduta attiva e a breve termine grazie alla base oscillante. Base rotonda con colonna centrale in metallo verniciato nero a polveri epossidiche con alzata gas, trattamento anti-scivolamento del basamento oscillante; seduta sagomata con struttura in legno multistrato imbottita in schiuma di poliuretano e rivestita.

Innovative multipurpose stool, ideal for active and short-term sitting thanks to the swinging base. Round base with central black epoxy powder coated metal column black, with gas lift, as well as non-slip base; shaped upholstered plywood seat with polyurethane foam.

Tabouret polyvalent innovant, idéal pour les sessions actives et de courte durée grâce à sa base oscillante. Piétement en métal rond peint noir avec élévation gaz, traitement anti-glissement de la base oscillante; assise en bois contreplaqué, rembourré en mousse de polyuréthane et revêtue.

Oblò task stool / Wolin 7050.31 - 7050.36 - 7050.22

struttura
multistrato di faggio

base nylon nero e acciaio

rivestimento
tessuto

pelle
ecopelle

frame
beech plywood

black nylon and steel base

upholstery
fabric

genuine leather
faux leather

structure
contreplaqué de hêtre

piétement en nylon noir et acier

revêtement
tissu

cuir
simili cuir

Rivestimenti
Upholstery | Nuanciers

JET / CAT. F

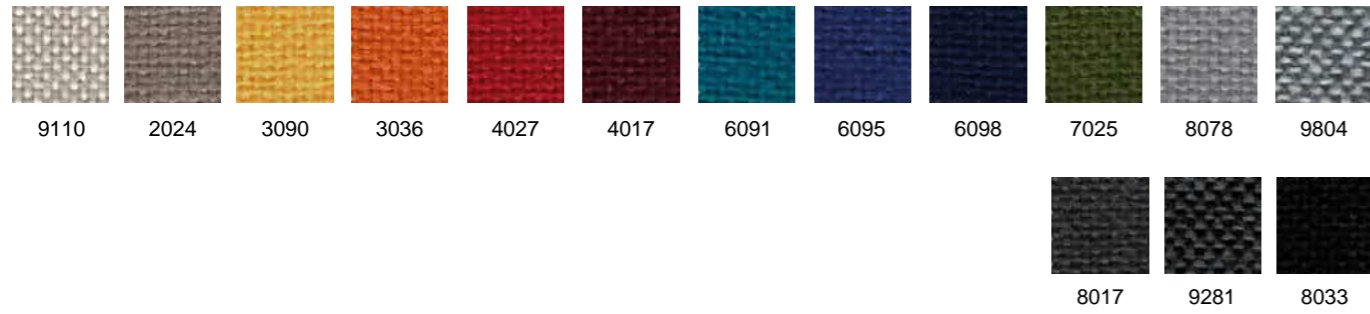

ERA / CAT. S



PLANET - SURROUND / CAT. F



IKON / CAT. TOP

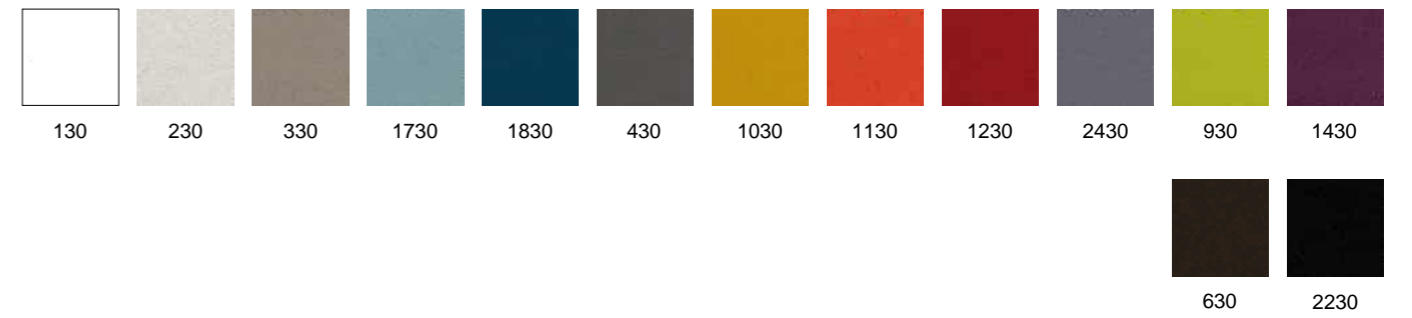

BINGO ELAST - MIRAGE / CAT. G

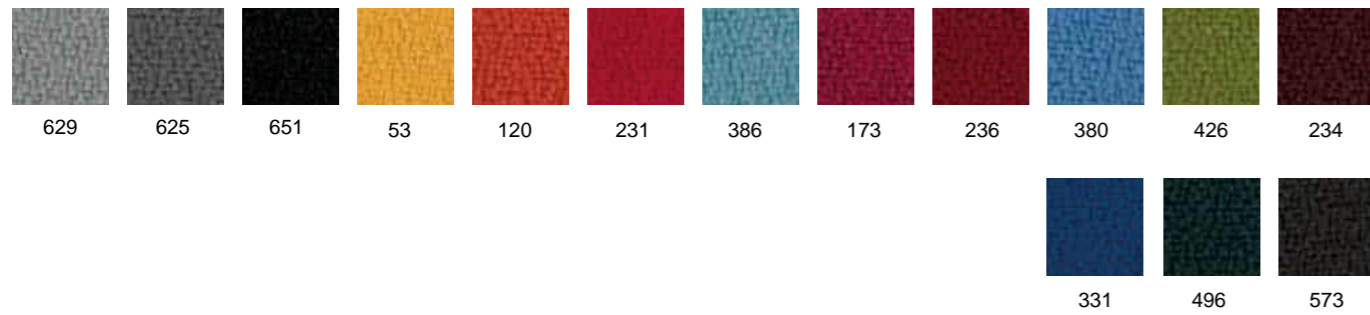

BLAZER / CAT. EXTRA



CUBE / CAT. G

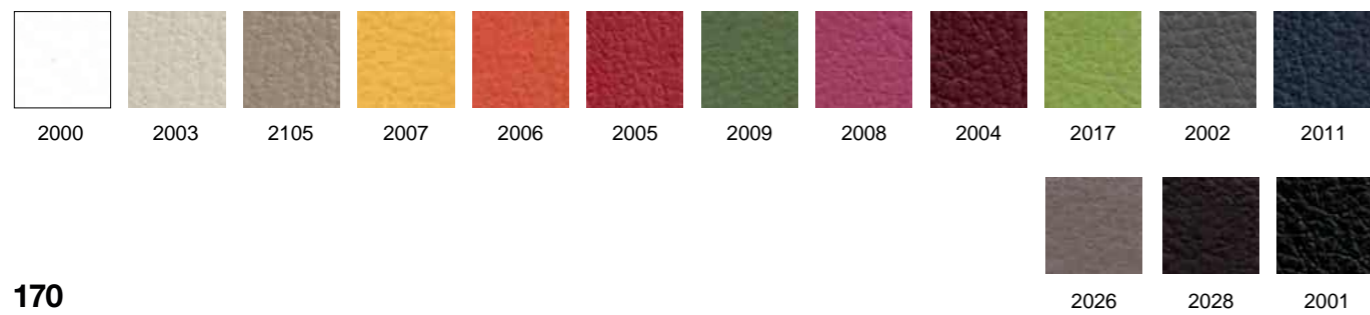

GORGEOUS / CAT. EXTRA

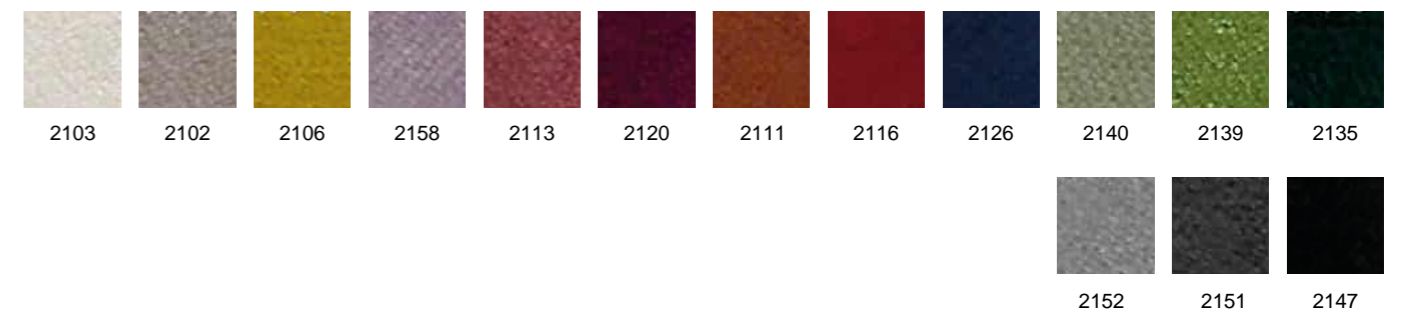

HESTAN / CAT. EXTRA

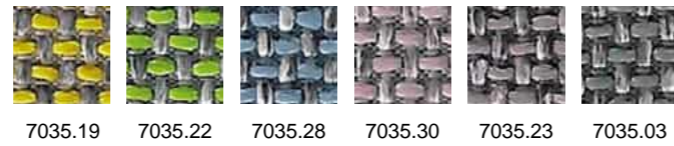

WOLIN / CAT. EXTRA



POLO / CAT. FIESTA

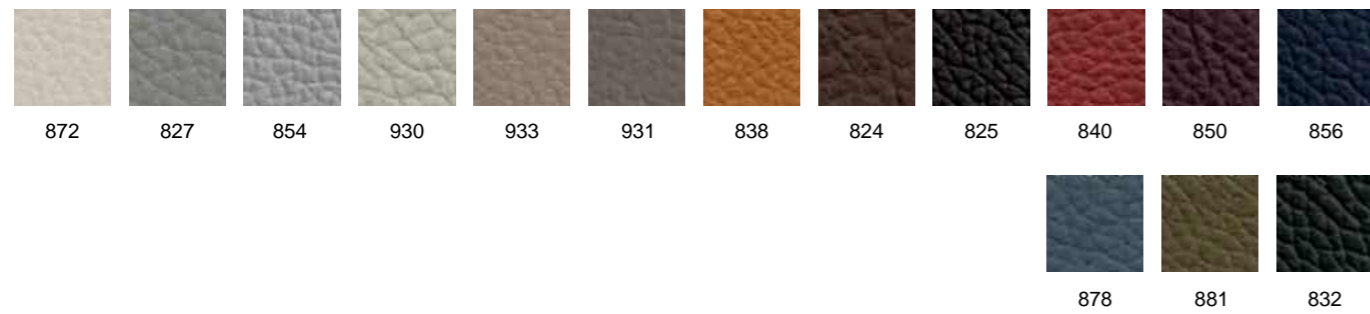

FIESTA



NUVOLA

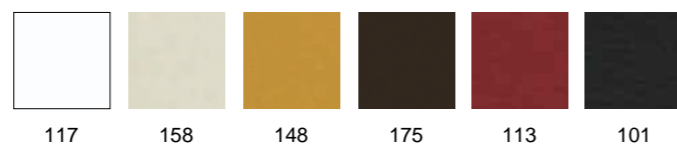

SEDIA IN CUOIO | Hide | Cuir sellier / CLOP



RETI | Mesh | Résille / AUCKLAND

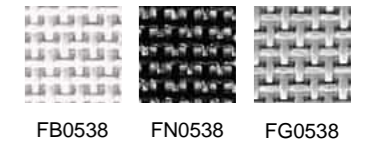

RETI | Mesh | Résille / GOAL / HOP / LEAD / NEW BONN / SOCIAL

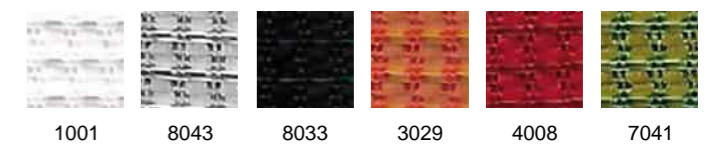

RETI | Mesh | Résille / LIBERTY

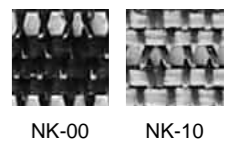

RETI | Mesh | Résille / FIT / SOCIAL



POLIPROPILENE | Polypropylene | Polypropylène / NEW BONN

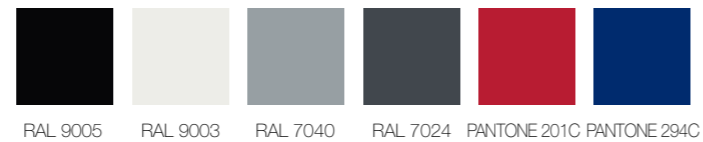

POLIPROPILENE | Polypropylene | Polypropylène / CLOP



POLIPROPILENE | Polypropylene | Polypropylène / NO FRILL

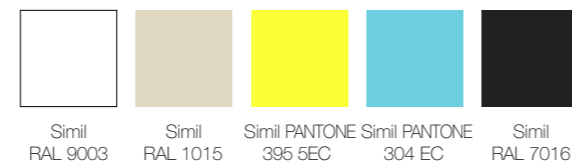

POLIURETANO RIGIDO TECH | Tech polyurethane | Tech polyuréthane / EON

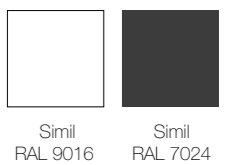

POLIPROPILENE | Polypropylene | Polypropylène / NUKE



COLORI BICOLOR | Two-colors shell | Coque bicolore / EON

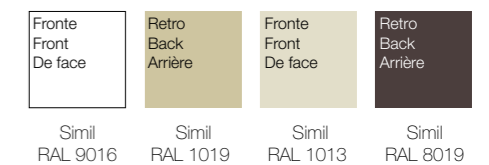

POLIPROPILENE | Polypropylene | Polypropylène / REDHOT



POLIETILENE SEDIA | Polyethylene chair | Polyéthylène chaise / MARGARITA



POLIPROPILENE | Polypropylene | Polypropylène / SLIM

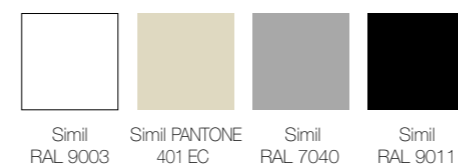

POLIETILENE TAVOLO | Polyethylene table | Polyéthylène table / MARGARITA



POLIPROPILENE | Polypropylene | Polypropylène / SUNNY NEW

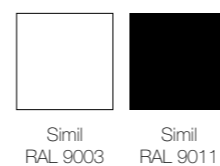



Distributor pro ČR a SK
www.mintiga.cz
obchod@mintiga.cz
+420 724 124 042

Art direction: Priority Design

Graphic design concept: Priority Design

Photo: Arch. Prior Vinicio

Styling: Baliviera Enrica

Post production: Priority Design

Printed by: Graficart Arti Grafiche

Thanks to: Artemide | Axia | Brionvega | Campana Moquette | Cini&Nils | Joe Colombo | Seletti | Venini

09/2020

Diemme Srl

Via del Lavoro, 25 | 31013 Codognè TV | Italy

T. +39 0438 778211

F. +39 0438 479836

dm@diemmeoffice.com

www.diemmeoffice.com

Diemme.