



**MOKA**  
wardrobe storage system

by emuca 

# COMPOSITIONS

Composizioni . Composiciones . Compositions . Composições

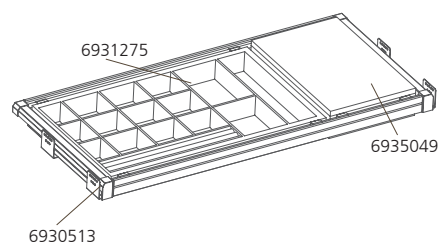
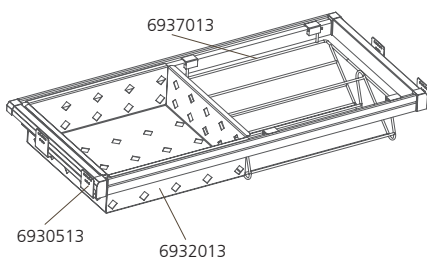
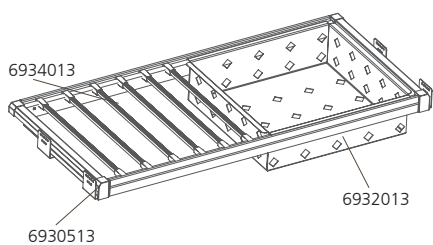
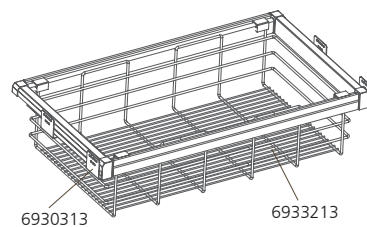
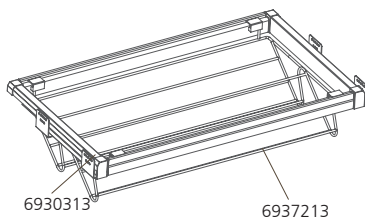
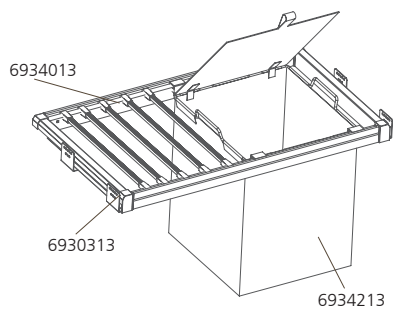
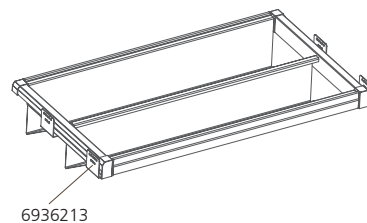
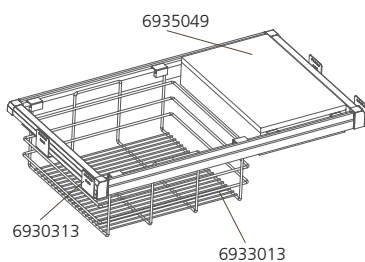
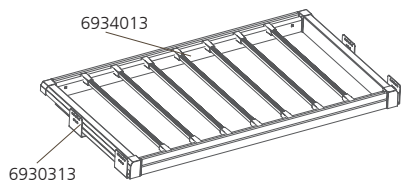
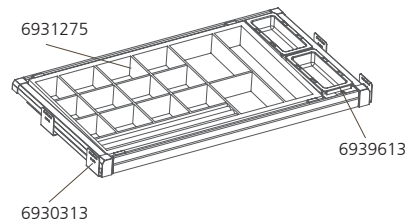
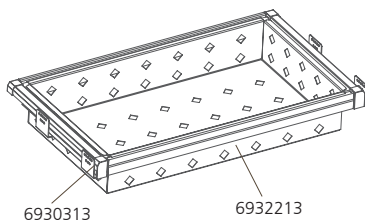
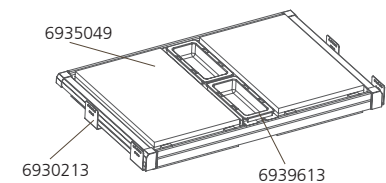

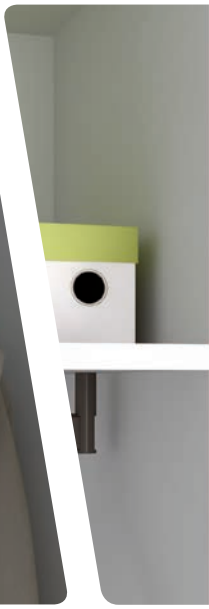

# MOKA

wardrobe storage system

by emuca 

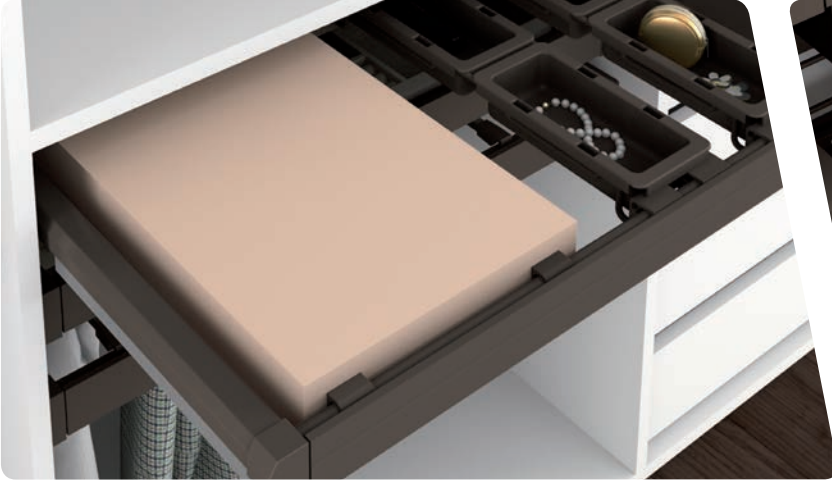

## Pull-out hanging rail

Appendiabiti - Colgador abatible  
Penderie rabattable - Varão basculante

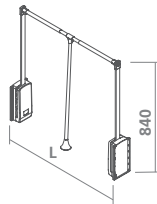

L	Cod.	
450 - 600	92837 13	1
600 - 830	92838 13	1
830 - 1.150	92839 13	1

ST / PL

## Rails and supports

Tubi e reggitubi - Tubos y soportes - Tringles et supports - Varões e suportes



L	Cod.	
4 m	70141 13	40 m
2 m	70142 13	20 m

AL

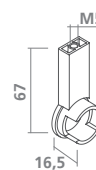

Cod.	
79192 13	200

ZM

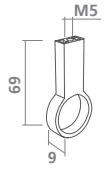

Cod.	
79197 13	200

ZM

## MOKA FRAME WITH RUNNERS

Telaio Moka con guide - Bastidor con guías Moka - Cadre coulissant Moka - Bastidor Moka com corredeiras

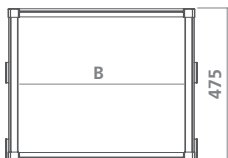
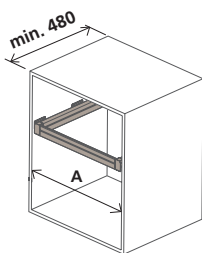

A	B	Cod.		
564 - 614	484 - 534	<b>69300</b>	<b>13</b>	1
614 - 664	534 - 584	<b>69299</b>	<b>13</b>	1
664 - 714	584 - 634	<b>69301</b>	<b>13</b>	1
714 - 764	634 - 684	<b>69306</b>	<b>13</b>	1
764 - 814	684 - 734	<b>69302</b>	<b>13</b>	1
814 - 864	734 - 784	<b>69307</b>	<b>13</b>	1
864 - 914	784 - 834	<b>69303</b>	<b>13</b>	1
914 - 964	834 - 884	<b>69308</b>	<b>13</b>	1
964 - 1.014	884 - 934	<b>69304</b>	<b>13</b>	1
1.014 - 1.064	934 - 984	<b>69309</b>	<b>13</b>	1
1.064 - 1.114	984 - 1.034	<b>69305</b>	<b>13</b>	1

AL / PL

## Spacers

Distanziali - Distanciadores

Séparateurs - Distanciadores

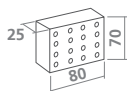

Cod.		
<b>69399</b>	<b>43</b>	1

PL

## Pull-out trouser rack

Porta pantaloni estraibile - Pantalonero estraibile

Porte-pantalons extractible - Porta calças extraível

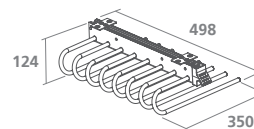

	Cod.		
LEFT	<b>69128</b>	<b>13</b>	1
RIGHT	<b>69234</b>	<b>13</b>	1

AL / PL



Runners included . Guide incluse . Incluye guías . Coulisses compris . Inclui corredeiras

## RACK ACCESSORIES MOKA

Accessori per telaio Moka - Accesorios para el bastidor Moka - Accessoires pour cadre coulissant Moka - Acesoários para bastidor Moka

### Metallic drawer

Cassetto metallico - Cajón metálico

Panier métallique - Gavetao metálico

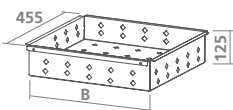

B	Cod.		
475	<b>69320 13</b>	1	
675	<b>69321 13</b>	1	
775	<b>69322 13</b>	1	

ST

### Wire drawer

Cassetto in filo - Cajón de alambre

Panier en fil - Gaveta de arame

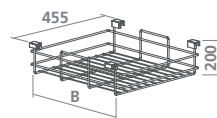

B	Cod.		
475	<b>69330 13</b>	2	
675	<b>69331 13</b>	2	
775	<b>69332 13</b>	2	

ST

### Shoe drawer

Porta scarpe - Cajón zapatero

Rangement de chaussures - Cesto sapateira

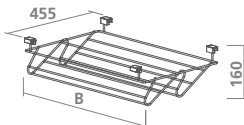
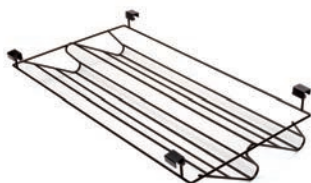

B	Cod.		
475	<b>69370 13</b>	2	
675	<b>69371 13</b>	2	
775	<b>69372 13</b>	2	

ST

### Organizer drawer

Cassetto organizzatore - Cajón organizador

Tiroir organisateur - Gaveta organizadora

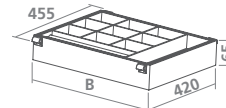

B	Cod.		
483	<b>69310 75</b>	1	
683	<b>69311 75</b>	1	
783	<b>69312 75</b>	1	

Wood

### Basket

Cesta - Cesto - Panier - Cesto

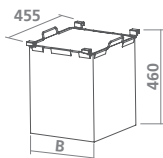

B	Cod.		
355	<b>69342 13</b>	1	

ST

### Wooden tray with lid

Cassetto di legno - Cajón de madera

Tiroir en bois - Gaveta de madeira

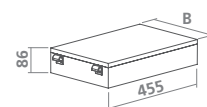

B	Cod.		
270	<b>69350 49</b>	1	

Wood

### Auxiliary tray

Vaschetta ausiliare - Bandeja auxiliar

Plateaux auxiliaire - Travessa auxiliar

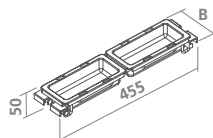

B	Cod.		
99	<b>69396 13</b>	1	

AL / PL

### Set of 7 trousers rods

Set di 7 aste porta pantaloni - Juego de 7 varillas pantalonero

Jeu 7 tringles porte-pantalons - Jogo de 7 varetas porta calças



Cod.			
<b>69340 13</b>	1		

AL / PL

AL, ST, PL, ZM, WOOD:

Aluminium, Steel, Plastic, Zamak, Wood • Alluminio, Acciaio, Tecnoplastica, Zama, Legno • Aluminio, Acero, Plástico, Zamak, Madera • Aluminium, Acier, Plastique, Zamak, Bois  
Alumínio, Aço, Plástico, Zamak, Madeira

## MOKA ACCESSORIES

Accessori Moka - Accesorios Moka - Accessoires Moka - Acessórios Moka

### Shoe rack with frame\*

Portascarpe con telaio - Zapatero con bastidor

Porte-chaussures avec cadre coulissant - Sapateira com bastidor

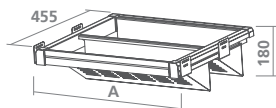

A	Cod.		
564 - 594	<b>69360 13</b>	1	
764 - 794	<b>69361 13</b>	1	
864 - 894	<b>69362 13</b>	1	

\*Frame included . Telaio include  
Incluye bastidor . Cadre compris  
Inclui bastidor

ST

### Lateral pull-out shoe rack

Porta scarpe laterale estraibile - Zapatero lateral extraíble

Rangement de chaussures latéral extractible - Sapateira lateral extraível

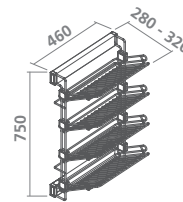

LEFT



RIGHT



	Cod.		
LEFT	<b>69384 13</b>	1	
RIGHT	<b>69385 13</b>	1	

ST

### Pull-out hanging rail

Appendiabiti estraibile - Colgador extraíble

Porte-vêtements extractible - Cabide extraível

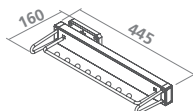

Cod.		
<b>69387 13</b>	1	

AL / PL

### Lateral pull-out tie rack\*

Porta cravatte laterale estraibile - Corbatero lateral extraíble

Porta cravatas latéral extractible - Porta gravatas lateral extraível

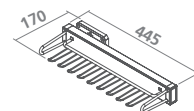

Cod.		
<b>69388 13</b>	1	

AL / PL

\* Fastening on both sides . Fissaggio su ambo i lati  
Fijación a ambos lados . Fixation sur les deux côtés  
Fixação a ambos lados

### Pull-out mirror

Specchio estraibile - Espejo extraíble

Miroir extractible - Espelho extraível

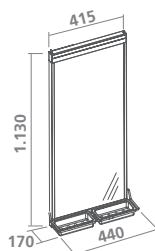

Cod.		
<b>69386 13</b>	1	

AL / PL



13 Moka painted . Verniciato moka . Pintado moka . Peint couleur moka . Pintado moka

43 Moka plastic . Plastica moka . Plástico moka . Plastique moka . Plástico moka

49 Sand painted . Verniciato sabbia . Pintado arena . Peint couleur sable . Pintado areia

75 Walnut wood . Legno noce . Madera nogal . Bois de noyer . Madeira nogueira

emuca 

emuca.com

emuca.it • emuca.co.uk • emuca.es • emuca.fr • emuca.pt

**Emuca S.R.L.**

Via Messico, 80 • 35127 Padova (ITALIA)  
T. +39 049 8702800 • F. +39 049 8703019  
[www.emuca.it](http://www.emuca.it) • [info@emuca.com](mailto:info@emuca.com)

**Emuca Ltd.**

75 Springfield Road • Chelmsford • Essex  
CM2 6JB (UK)  
T. +44 1268 530 674 • F. +44 1268 282 592  
[www.emuca.co.uk](http://www.emuca.co.uk) • [sales@emuca.com](mailto:sales@emuca.com)

**Emuca S.A.**

Pl. El Oliveral - c/H, 4 • Apartado de correos 176  
46394 Riba-Roja del Túria • Valencia (ESPAÑA)  
T. +34 96 166 70 19 • F. +34 96 166 71 82  
[www.emuca.es](http://www.emuca.es) • [emuca@emuca.com](mailto:emuca@emuca.com)

**Emuca S.A.R.L.**

Parc de l'Aubinière • 2 Av. des Améthystes  
44338 Nantes Cedex 03 (FRANCE)  
T. +33 2 49 88 07 35 • F. +33 2 72 22 02 24  
[www.emuca.fr](http://www.emuca.fr) • [emuca@emuca.com](mailto:emuca@emuca.com)

**Emuca Lda.**

AV. da Liberdade nº 36, 6º • 01250 Lisboa (PORTUGAL)  
T. +351 211 203 940 • F. +34 96 166 71 82  
[www.emuca.pt](http://www.emuca.pt) • [emuca@emuca.com](mailto:emuca@emuca.com)



05/2017 Cod. 900285

