

PLACARD

SLIDING



emuca 



INDEX



CONFIGURATOR
PLACARD

Try it now and place your order.



4 Placard 74



16 Placard 81



30 Placard 90



38 Glass door
Cabinets with sloping ceiling

PLACARD

74



BINARI INFERIORI E SUPERIORI

LOWER AND UPPER TRACKS

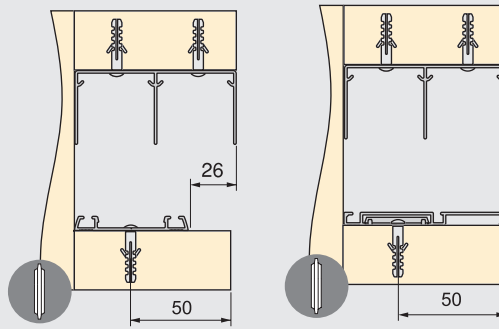
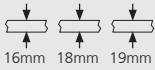

CALCOLO MISURA ANTA

HOW TO CALCULATE THE DOOR

Model		normal	slow
	SCREW		
	CLIP	H = HI - 42	



Da utilizzare con il carrello 6102114, arretrare di 3 mm eventuali divisori centrali.
To use with wheel 6102114 recess 3 mm from the central divider.

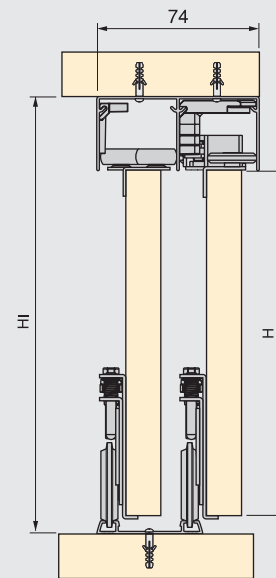

LARGHEZZA MINIMA DELLA PORTA CON SLOWMOVE

WIDTH OF THE DOOR WITH SLOWMOVE



A min.	634 mm	634 mm	642 mm	634 mm	634 mm	634 mm	634 mm

MANIGLIE

HANDLES



2-3 Ante / Doors

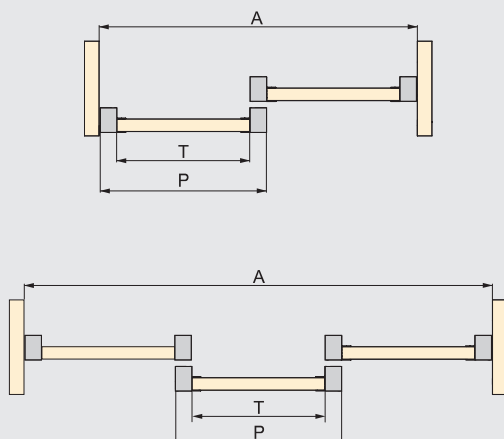

Model		
Wave	$T = \frac{A - 50}{2}$ $P = \frac{A + 18}{2}$	$T = \frac{A - 66}{3}$ $P = \frac{A + 35}{3}$
Sharp	$T = \frac{A - 12}{2}$ $P = \frac{A + 12}{2}$	$T = \frac{A - 12}{3}$ $P = \frac{A + 24}{3}$

SET PLACARD 74 // KIT PLACARD 74

Set di binari per Placard 74 a Canale

Track set of Placard 74 of Groove

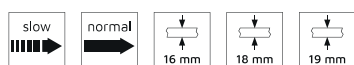

Lunghezza Longitude	Finitura Finishing	Imballo Packaging	Cod.
2,35 m	Verniciato bianco White painted	1 UN/Ut.	6307712
3,9 m	Verniciato bianco White painted	1 UN/Ut.	6055512
2,35 m	Anodizzato opaco Matt anodized	1 UN/Ut.	6307762
3,9 m	Anodizzato opaco Matt anodized	1 UN/Ut.	6055562

Alluminio
Aluminium

Set di binari per Placard 74 a Canale clip

Track set of Placard 74 of groove with clip systems

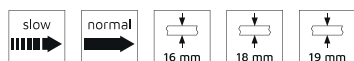

Lunghezza Longitude	Finitura Finishing	Imballo Packaging	Cod.
2,35 m	Verniciato bianco White painted	1 UN/Ut.	6307912
3,9 m	Verniciato bianco White painted	1 UN/Ut.	6055812
2,35 m	Verniciato nero Black painted	1 UN/Ut.	6307914
3,9 m	Verniciato nero Black painted	1 UN/Ut.	6055814
2,35 m	Anodizzato opaco Matt anodized	1 UN/Ut.	6307962
3,9 m	Anodizzato opaco Matt anodized	1 UN/Ut.	6055862

Alluminio
Aluminium

Set de maniglie Wave 16 e 19 per una porta scorrevole

Handle profile set Wave 16 and 19 for one sliding door

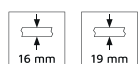

Spessore pannello Board thickness	Lunghezza Longitude	Finitura Finishing	Imballo Packaging	Cod.
16	2,35 m	Verniciato bianco White painted	1 UN/Ut.	6308112
19	2,35 m	Verniciato bianco White painted	1 UN/Ut.	6308212
19	2,7 m	Verniciato bianco White painted	1 UN/Ut.	6311312
16	2,35 m	Anodizzato opaco Matt anodized	1 UN/Ut.	6308162
16	2,6 m	Anodizzato opaco Matt anodized	1 UN/Ut.	6056062
19	2,35 m	Anodizzato opaco Matt anodized	1 UN/Ut.	6308262
19	2,7 m	Anodizzato opaco Matt anodized	1 UN/Ut.	6311362









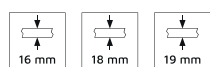
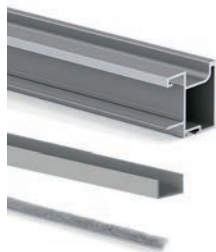



Alluminio
Aluminium

SET PLACARD 74 // KIT PLACARD 74

Set de maniglie Sharp 16, 18 e 19 per una porta scorrevole

Handle profile set Sharp 16, 18 and 19 for one sliding door



Spessore pannello Board thickness	Lunghezza Longitude	Finitura Finishing	Imballo Packaging	Cod.
16	2,7 m	Verniciato bianco White painted		1 UN./Ut. 6311012
18	2,9 m	Verniciato bianco White painted		1 UN./Ut. 6312612
19	2,7 m	Verniciato bianco White painted		1 UN./Ut. 6311212
19	2,35 m	Verniciato bianco White painted		1 UN./Ut. 6308512
16	2,7 m	Verniciato nero Black painted		1 UN./Ut. 6311014
18	2,9 m	Verniciato nero Black painted		1 UN./Ut. 6311114
19	2,35 m	Verniciato nero Black painted		1 UN./Ut. 6308514
19	2,7 m	Verniciato nero Black painted		1 UN./Ut. 6311214
16	2,7 m	Anodizzato opaco Matt anodized		1 UN./Ut. 6311062
18	2,9 m	Anodizzato opaco Matt anodized		1 UN./Ut. 6311162
19	2,35 m	Anodizzato opaco Matt anodized		1 UN./Ut. 6308562
19	2,7 m	Anodizzato opaco Matt anodized		1 UN./Ut. 6311262

Alluminio
Aluminium

SISTEMA PLACARD 74 // PLACARD 74 SYSTEM

Set di ferramenta Slowmove per anta (Ammortizzatori) scorrevole

Set of fittings Slowmove for door (Soft-closing) for sliding door



Spessore pannello Board thickness	Finitura Finishing	Imballo Packaging	Cod.
16 - 18 - 19	Transparente / non classificata Transparent / not defined	<input type="checkbox"/>	2 UN/Ut. 6108320
16 - 18 - 19	Transparente / non classificata Transparent / not defined	<input type="checkbox"/>	2 UN/Ut. 6108420

Tecnoplastica
Plastic

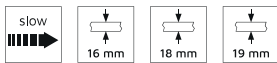

Set di ferramenta per anta con ammortizzatori (Carrelli) scorrevole

Set of fittings for sliding door with soft-closing



Spessore pannello Board thickness	Modello Model	Finitura Finishing	Imballo Packaging	Cod.
16 - 18 - 19	Canale Groove	Transparente / non classificata Transparent / not defined	<input type="checkbox"/>	1 UN/Ut. 6109720

Acciaio, Tecnoplastica
Plastic, Steel

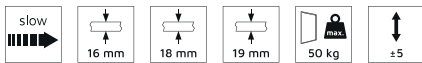

Set di ferramenta per anta con Slowmove (Carrelli)

Set of fittings for door with Slowmove (Carriage)



Modello Model	Finitura Finishing	Imballo Packaging	Cod.
Canale Groove	Transparente / non classificata Transparent / not defined	<input type="checkbox"/>	4 UN/Ut. 6108020
Classico Classic	Transparente / non classificata Transparent / not defined	<input type="checkbox"/>	4 UN/Ut. 6108120

Acciaio, Tecnoplastica
Plastic, Steel

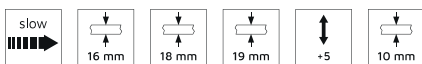

Set di ferramenta Placard 74 per anta scorrevole

Set of Placard 74 fittings for door for sliding door



Spessore pannello Board thickness	Modello Model	Finitura Finishing	Imballo Packaging	Cod.
16 - 18 - 19	Canale Groove	Transparente / non classificata Transparent / not defined	<input type="checkbox"/>	4 UN/Ut. 6109820

Acciaio, Tecnoplastica
Plastic, Steel



SISTEMA PLACARD 74 // PLACARD 74 SYSTEM

Carrello inferiore Placard 74 per porte scorrevoli

Inferior carriage Placard 74 for sliding door



Modello Model	Finitura Finishing	Imballo Packaging	Cod.
Canale Groove	Zincato bianco Zinc plated		50 UN/Ut. 6109505

Acciaio, Tecnoplastica
Plastic, Steel

Carrello Placard per porte scorrevoli

Carriage Placard for sliding door



Modello Model	Finitura Finishing	Imballo Packaging	Cod.
Classico Classic	Verniciato nero Black painted		50 UN/Ut. 6012214
Canale Groove	Verniciato nero Black painted		50 UN/Ut. 6102114

Acciaio, Tecnoplastica
Plastic, Steel

Pattino superiore Placard 74 per porte scorrevoli

Placard 74 roller for sliding door

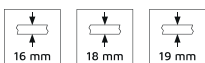

Spessore pannello Board thickness	Finitura Finishing	Imballo Packaging	Cod.
16 - 18 - 19	Zincato bianco Zinc plated		100 UN/Ut. 6109605

Acciaio, Tecnoplastica
Plastic, Steel

Freno Placard per porte scorrevoli

Placard brake for sliding door



Finitura Finishing	Imballo Packaging	Cod.
Plastica grigia Grey plastic		100 UN/Ut. 6102021

Tecnoplastica
Plastic

BINARI PLACARD 74 // PLACARD 74 TRACKS

Binari superiori Placard a Canale per porte scorrevoli

Classic Placard upper track of Groove for sliding door

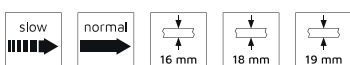
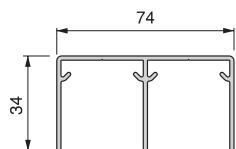

Binario inferiore Placard a Canale

Placard lower track of Groove

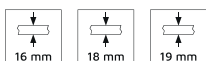
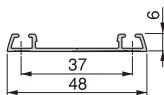

Binario inferiore Placard a Canale Clip per porte scorrevoli

Placard lower track of Groove with Clip systems for sliding door

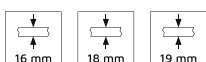
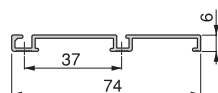

Lunghezza Longitude	Finitura Finishing	Imballo Packaging	Cod.
2,35 m	Verniciato bianco White painted	8 UN/Ut.	6056912
3,9 m	Verniciato bianco White painted	8 UN/Ut.	6054512
2,35 m	Verniciato nero Black painted	8 UN/Ut.	6056914
3,9 m	Verniciato nero Black painted	8 UN/Ut.	6054514
2,35 m	Grigio antracite Anthracite grey	8 UN/Ut.	6056935
3,9 m	Grigio antracite Anthracite grey	8 UN/Ut.	6054535
2,35 m	Anodizzato opaco Matt anodized	8 UN/Ut.	6056962
3,9 m	Anodizzato opaco Matt anodized	8 UN/Ut.	6054562

Alluminio Aluminium

Lunghezza Longitude	Finitura Finishing	Imballo Packaging	Cod.
2,35 m	Verniciato bianco White painted	8 UN/Ut.	6056712
3,9 m	Verniciato bianco White painted	8 UN/Ut.	6054812
2,35 m	Verniciato nero Black painted	8 UN/Ut.	6056714
3,9 m	Verniciato nero Black painted	8 UN/Ut.	6054814
2,35 m	Grigio antracite Anthracite grey	8 UN/Ut.	6056735
3,9 m	Grigio antracite Anthracite grey	8 UN/Ut.	6054835
2,35 m	Anodizzato opaco Matt anodized	8 UN/Ut.	6056762
3,9 m	Anodizzato opaco Matt anodized	8 UN/Ut.	6054862

Alluminio Aluminium

Lunghezza Longitude	Finitura Finishing	Imballo Packaging	Cod.
2,35 m	Verniciato bianco White painted	8 UN/Ut.	6300112
3,9 m	Verniciato bianco White painted	8 UN/Ut.	6055112
2,35 m	Verniciato nero Black painted	8 UN/Ut.	6300114
3,9 m	Verniciato nero Black painted	8 UN/Ut.	6055114
2,35 m	Grigio antracite Anthracite grey	8 UN/Ut.	6300135
3,9 m	Grigio antracite Anthracite grey	8 UN/Ut.	6055135
2,35 m	Anodizzato opaco Matt anodized	8 UN/Ut.	6300162
3,9 m	Anodizzato opaco Matt anodized	8 UN/Ut.	6055162

Alluminio Aluminium

BINARI PLACARD 74 // PLACARD 74 TRACKS

Clip per porte scorrevoli

Clip for sliding door



Finitura Finishing	Imballo Packaging	Cod.
Plastica nera Black plastic	 25 UN/Ut.	6009017
Tecnoplastica Plastic		

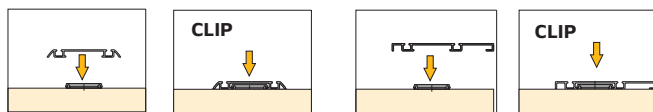

MANIGLIE PLACARD 74 // HANDLES PLACARD 74

Maniglia per armadio Wave 16

Handle for wardrobe Wave 16

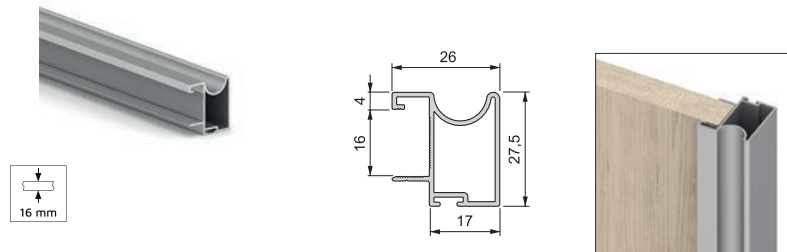

Lunghezza Longitude	Finitura Finishing	Imballo Packaging	Cod.
2,35 m	Verniciato bianco White painted	8 UN/Ut.	6057512
2,7 m	Verniciato bianco White painted	8 UN/Ut.	6053212
2,35 m	Anodizzato opaco Matt anodized	8 UN/Ut.	6057562
2,7 m	Anodizzato opaco Matt anodized	8 UN/Ut.	6053262

Alluminio Aluminium

Maniglia per armadio Sharp 16

Handle for wardrobe Sharp 16

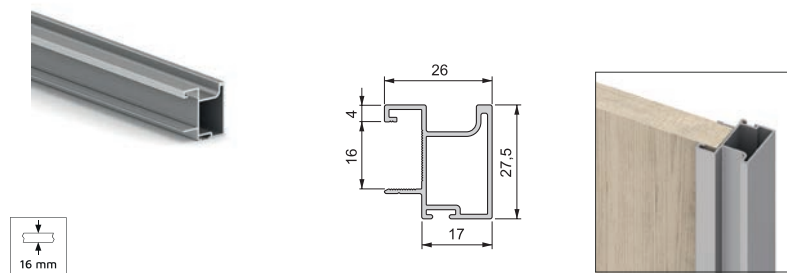

Lunghezza Longitude	Finitura Finishing	Imballo Packaging	Cod.
2,35 m	Verniciato bianco White painted	8 UN/Ut.	6306712
2,7 m	Verniciato bianco White painted	8 UN/Ut.	6053412
2,35 m	Verniciato nero Black painted	8 UN/Ut.	6306714
2,7 m	Verniciato nero Black painted	8 UN/Ut.	6053414
2,35 m	Grigio antracite Anthracite grey	8 UN/Ut.	6306735
2,7 m	Grigio antracite Anthracite grey	8 UN/Ut.	6053435
2,35 m	Anodizzato opaco Matt anodized	8 UN/Ut.	6306762
2,7 m	Anodizzato opaco Matt anodized	8 UN/Ut.	6053462

Alluminio Aluminium

Maniglia per armadio Style 16

Handle for wardrobe Style 16

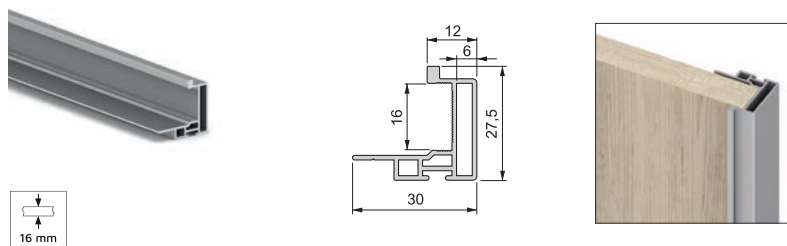

Lunghezza Longitude	Finitura Finishing	Imballo Packaging	Cod.
2,35 m	Verniciato bianco White painted	8 UN/Ut.	6306812
2,7 m	Verniciato bianco White painted	8 UN/Ut.	6053012
2,35 m	Anodizzato opaco Matt anodized	8 UN/Ut.	6306862
2,7 m	Anodizzato opaco Matt anodized	8 UN/Ut.	6053062

Alluminio Aluminium

MANIGLIE PLACARD 74 // HANDLES PLACARD 74

Maniglia per armadio Sharp 18

Handle for wardrobe Sharp 18

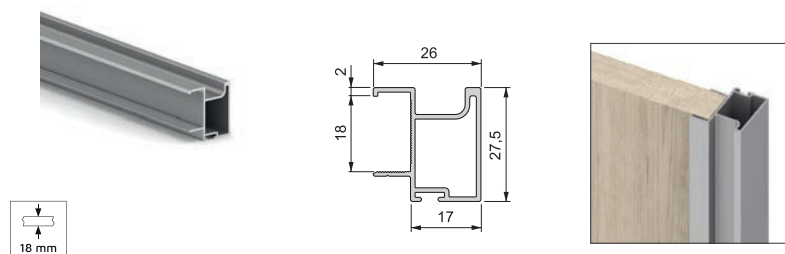

Lunghezza Longitude	Finitura Finishing	Imballo Packaging	Cod.
2,35 m	Verniciato bianco White painted	8 UN/Ut.	6057112
2,9 m	Verniciato bianco White painted	8 UN/Ut.	6053812
2,35 m	Verniciato nero Black painted	8 UN/Ut.	6057114
2,9 m	Verniciato nero Black painted	8 UN/Ut.	6053814
2,35 m	Grigio antracite Anthracite grey	8 UN/Ut.	6057135
2,9 m	Grigio antracite Anthracite grey	8 UN/Ut.	6053835
2,35 m	Anodizzato opaco Matt anodized	8 UN/Ut.	6057162
2,9 m	Anodizzato opaco Matt anodized	8 UN/Ut.	6053862

Alluminio Aluminium

Maniglia per armadio Wave 19

Handle for wardrobe Wave 19

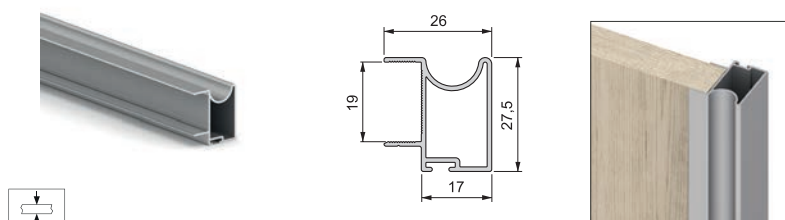

Lunghezza Longitude	Finitura Finishing	Imballo Packaging	Cod.
2,35 m	Verniciato bianco White painted	8 UN/Ut.	6300612
2,7 m	Verniciato bianco White painted	8 UN/Ut.	6054012
2,35 m	Anodizzato opaco Matt anodized	8 UN/Ut.	6300662
2,7 m	Anodizzato opaco Matt anodized	8 UN/Ut.	6054062

Alluminio Aluminium

Maniglia per armadio Sharp 19

Handle for wardrobe Sharp 19

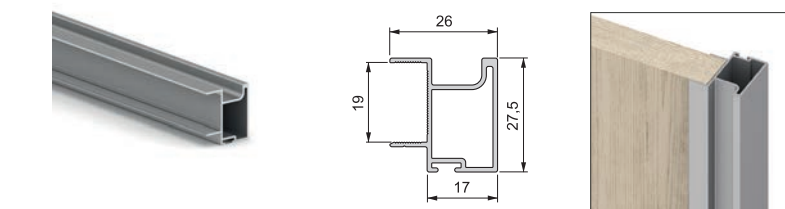

Lunghezza Longitude	Finitura Finishing	Imballo Packaging	Cod.
2,35 m	Verniciato bianco White painted	8 UN/Ut.	6307312
2,7 m	Verniciato bianco White painted	8 UN/Ut.	6054212
2,35 m	Verniciato nero Black painted	8 UN/Ut.	6307314
2,7 m	Verniciato nero Black painted	8 UN/Ut.	6054214
2,35 m	Grigio antracite Anthracite grey	8 UN/Ut.	6307335
2,7 m	Grigio antracite Anthracite grey	8 UN/Ut.	6054235
2,35 m	Anodizzato opaco Matt anodized	8 UN/Ut.	6307362
2,7 m	Anodizzato opaco Matt anodized	8 UN/Ut.	6054262

Alluminio Aluminium

TRAVERSI PLACARD 74 // PLACARD 74 CROSS-PIECES

Traverso Placard H16x18

Crossbeams Placard H16x18

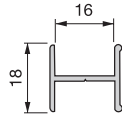

Lunghezza Longitude	Finitura Finishing	Imballo Packaging	Cod.
1,15 m	Verniciato bianco White painted	8 UN/Ut.	6312012
2,35 m	Verniciato nero Black painted	8 UN/Ut.	6300814
2,35 m	Grigio antracite Anthracite grey	8 UN/Ut.	6300835
1,15 m	Anodizzato opaco Matt anodized	8 UN/Ut.	6312062

Alluminio
Aluminium

Traverso Placard U19x14

Crossbeams Placard U19x14

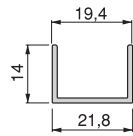

Lunghezza Longitude	Finitura Finishing	Imballo Packaging	Cod.
1,15 m	Verniciato bianco White painted	8 UN/Ut.	6312512
2,35 m	Verniciato bianco White painted	8 UN/Ut.	6103112
2,35 m	Verniciato nero Black painted	8 UN/Ut.	6103114
2,35 m	Grigio antracite Anthracite grey	8 UN/Ut.	6103135
1,15 m	Anodizzato opaco Matt anodized	8 UN/Ut.	6312562
2,35 m	Anodizzato opaco Matt anodized	8 UN/Ut.	6103162

Alluminio
Aluminium

Traverso Placard H18x12/22

Cross-pieces Placard H18x12/22

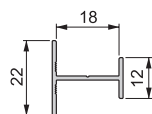

Lunghezza Longitude	Finitura Finishing	Imballo Packaging	Cod.
2,35 m	Verniciato nero Black painted	8 UN/Ut.	6305614
2,35 m	Grigio antracite Anthracite grey	8 UN/Ut.	6305635
1,15 m	Anodizzato opaco Matt anodized	8 UN/Ut.	6312262
2,35 m	Anodizzato opaco Matt anodized	8 UN/Ut.	6305662

Alluminio
Aluminium

TRAVERSI PLACARD 74 // PLACARD 74 CROSS-PIECES

Traverso Placard H19x12/22

Crossbeams Placard H19x12/22

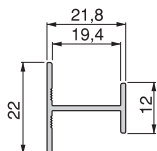

Lunghezza Longitude	Finitura Finishing	Imballo Packaging	Cod.
1,15 m	Verniciato bianco White painted	8 UN/Ut.	6312412
2,35 m	Verniciato bianco White painted	8 UN/Ut.	6102912
2,35 m	Verniciato nero Black painted	8 UN/Ut.	6102914
2,35 m	Grigio antracite Anthracite grey	8 UN/Ut.	6102935
1,15 m	Anodizzato opaco Matt anodized	8 UN/Ut.	6312462
2,35 m	Anodizzato opaco Matt anodized	8 UN/Ut.	6102962

Alluminio Aluminium

Traverso Placard U16x14

Crossbeams Placard U16x14

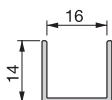

Lunghezza Longitude	Finitura Finishing	Imballo Packaging	Cod.
1,15 m	Verniciato bianco White painted	8 UN/Ut.	6312112
2,35 m	Verniciato bianco White painted	8 UN/Ut.	6300312
2,35 m	Verniciato nero Black painted	8 UN/Ut.	6300314
2,35 m	Grigio antracite Anthracite grey	8 UN/Ut.	6300335
1,15 m	Anodizzato opaco Matt anodized	8 UN/Ut.	6312162
2,35 m	Anodizzato opaco Matt anodized	8 UN/Ut.	6300362

Alluminio Aluminium

Traverso Placard U18x14

Crossbeams Placard U18x14

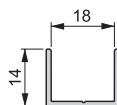

Lunghezza Longitude	Finitura Finishing	Imballo Packaging	Cod.
2,35 m	Verniciato nero Black painted	8 UN/Ut.	6305714
2,35 m	Grigio antracite Anthracite grey	8 UN/Ut.	6305735
1,15 m	Anodizzato opaco Matt anodized	8 UN/Ut.	6312362
2,35 m	Anodizzato opaco Matt anodized	8 UN/Ut.	6305762

Alluminio Aluminium

PLACARD

81



BINARI INFERIORI E SUPERIORI
LOWER AND UPPER TRACKS

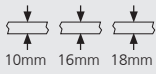

Model	X	Y
	20	49,5
	22	51,5

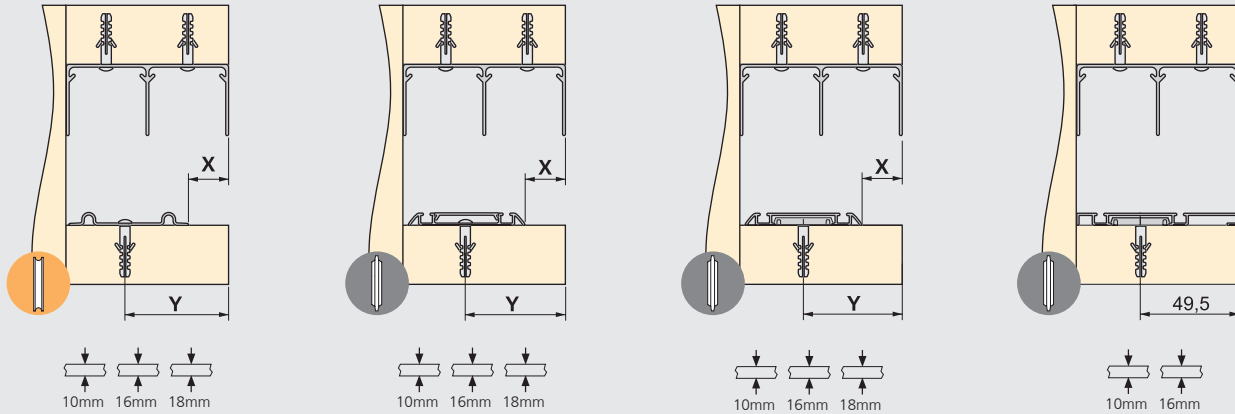

CALCOLO MISURA ANTA
HOW TO CALCULATE THE DOOR

Model		
 CLIP 	 SCREW 	H = HI - 42
 CLIP 		

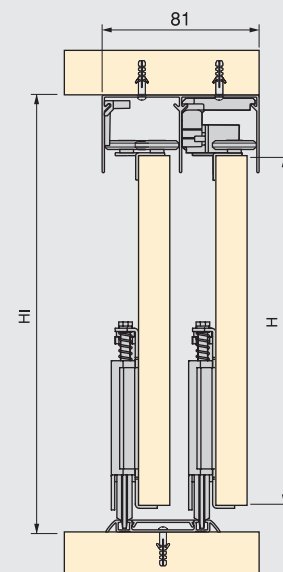

LARGHEZZA MINIMA DELLA PORTA CON SLOWMOVE

WIDTH OF THE DOOR WITH SLOWMOVE

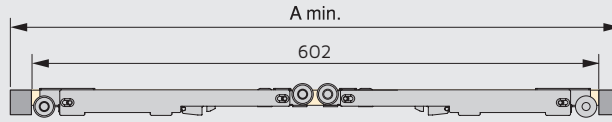

A min.	656 mm	674 mm	656 mm	640 mm	684 mm	656 mm	656 mm	684 mm

MANIGLIE
HANDLES

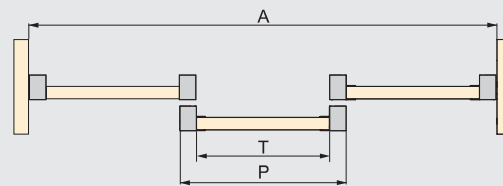
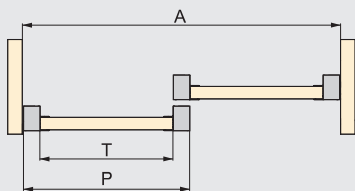

Model				
Wave	$T = \frac{A - 64}{2}$	$P = \frac{A + 20}{2}$	$T = \frac{A - 86}{3}$	$P = \frac{A + 40}{3}$
Style	$T = \frac{A + 16}{2}$	$P = \frac{A + 22}{2}$	$T = \frac{A + 35}{3}$	$P = \frac{A + 44}{3}$
Sharp	$T = \frac{A - 45}{2}$	$P = \frac{A + 15}{2}$	$T = \frac{A - 60}{3}$	$P = \frac{A + 15}{3}$
Quad	$T = \frac{A - 105}{2}$	$P = \frac{A + 35}{2}$	$T = \frac{A - 140}{3}$	$P = \frac{A + 70}{3}$
Deep	$T = \frac{A - 64}{2}$	$P = \frac{A + 20}{2}$	$T = \frac{A - 86}{3}$	$P = \frac{A + 40}{3}$

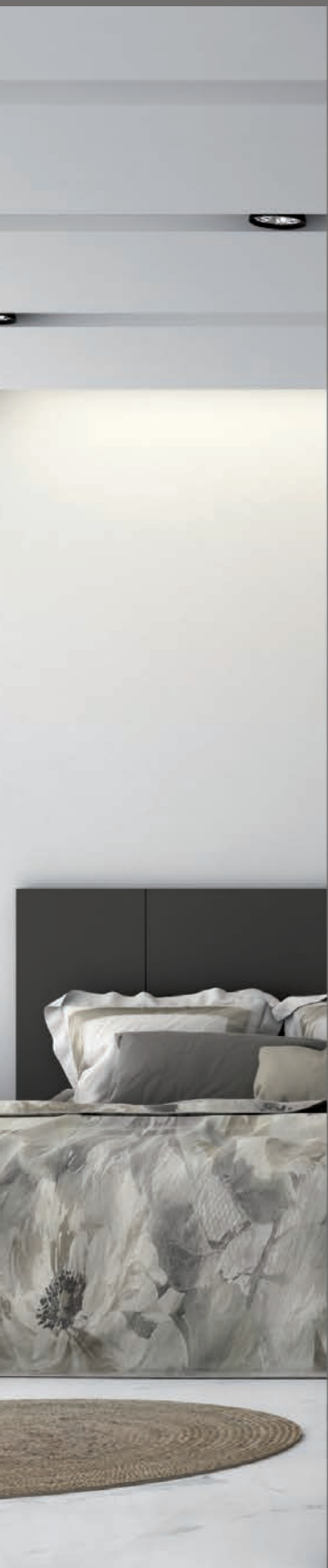

SET PLACARD 81 // KIT PLACARD 81

Set di binari per Placard a Canale

Track set of Placard of Groove



Descrizioni Description	Lunghezza Longitude	Finitura Finishing	Imballo Packaging	Cod.
Binario superiore 81x33 Rail supérieur 81x33	3,9 m	Anodizzato opaco Matt anodized	1 UN/Ut.	6032462
Binario superiore Soft 81x40 Upper track Soft 81x40	2,35 m	Anodizzato opaco Matt anodized	1 UN/Ut.	6309162
Binario superiore Soft 81x40 Upper track Soft 81x40	3,9 m	Anodizzato opaco Matt anodized	1 UN/Ut.	6901162

Alluminio
Aluminium

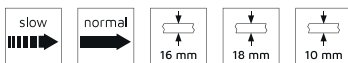

Set di binari per Placard a Canale clip per porte scorrevoli

Track set of Placard of groove with clip systems for sliding door



Lunghezza Longitude	Finitura Finishing	Imballo Packaging	Cod.
2,35 m	Verniciato bianco White painted	1 UN/Ut.	6309212
3,9 m	Verniciato bianco White painted	1 UN/Ut.	6901312
2,35 m	Anodizzato opaco Matt anodized	1 UN/Ut.	6309262
3,9 m	Anodizzato opaco Matt anodized	1 UN/Ut.	6901362

Alluminio
Aluminium

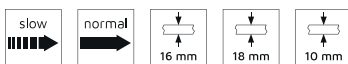

Set de maniglie Style 10 per una porta scorrevole

Handle profile set Style 10 for one sliding door



Lunghezza Longitude	Finitura Finishing	Imballo Packaging	Cod.
2,35 m	Verniciato bianco White painted	1 UN/Ut.	6309412
2,6 m	Verniciato bianco White painted	1 UN/Ut.	7012012
2,35 m	Anodizzato opaco Matt anodized	1 UN/Ut.	6309462
2,6 m	Anodizzato opaco Matt anodized	1 UN/Ut.	7012062

Alluminio, Vari
Aluminium, Various



Set de maniglie Wave 16 per una porta scorrevole

Handle profile set Wave 16 for one sliding door



Lunghezza Longitude	Finitura Finishing	Imballo Packaging	Cod.
2,35 m	Verniciato bianco White painted	1 UN/Ut.	6309512
2,6 m	Verniciato bianco White painted	1 UN/Ut.	7006412
2,35 m	Anodizzato opaco Matt anodized	1 UN/Ut.	6309562
2,6 m	Anodizzato opaco Matt anodized	1 UN/Ut.	7006462

Alluminio, Vari
Aluminium, Various



SET PLACARD 81 // KIT PLACARD 81

Set de maniglie Sharp 16 per una porta scorrevole (H)

Handle profile set Sharp 16 for one sliding door (H)



Spessore pannello Board thickness	Lunghezza Longitude	Finitura Finishing	Imballo Packaging	Cod.
16	2,7 m	Anodizzato opaco Matt anodized	 1 UN/Ut.	6311462

Alluminio
Aluminium

Set de maniglie Wave 18 per una porta scorrevole

Handle profile set Wave 18 for one sliding door



Lunghezza Longitude	Finitura Finishing	Imballo Packaging	Cod.
2,5 m	Anodizzato opaco Matt anodized	 1 UN/Ut.	7006662

Alluminio, Vari
Aluminium, Various

Set de maniglie Deep 18 per una porta scorrevole

Handle profile set Deep 18 for one sliding door



Spessore pannello Board thickness	Lunghezza Longitude	Finitura Finishing	Imballo Packaging	Cod.
18	2,9 m	Anodizzato opaco Matt anodized	 1 UN/Ut.	6311562

Alluminio
Aluminium

SISTEMA PLACARD 81 // PLACARD 81 SYSTEM

Set di ferramenta per anta con Slowmove (Ammortizzatori)

Set of fittings for door with Slowmove (Soft-closing)



Spessore pannello Board thickness	Finitura Finishing	Imballo Packaging	Cod.
10-16	Transparente / non classificata Transparent / not defined	<input type="checkbox"/>	2 UN/Ut. 6107420
18	Transparente / non classificata Transparent / not defined	<input type="checkbox"/>	2 UN/Ut. 6107520
10 - 16	Transparente / non classificata Transparent / not defined	<input type="checkbox"/>	2 UN/Ut. 6107720
18	Transparente / non classificata Transparent / not defined	<input type="checkbox"/>	2 UN/Ut. 6107820

Tecnoplastica
Plastic



Set di ferramenta per anta con Slowmove (Carrelli)

Set of fittings for door with Slowmove (Carriage)



Modello Model	Finitura Finishing	Imballo Packaging	Cod.
Canale Groove	Transparente / non classificata Transparent / not defined	<input type="checkbox"/>	4 UN/Ut. 6108020
Classico Classic	Transparente / non classificata Transparent / not defined	<input type="checkbox"/>	4 UN/Ut. 6108120

Acciaio, Tecnoplastica
Plastic, Steel

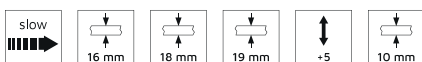

Ferrementa per una porta scorrevole

Set of fittings for sliding door



Spessore pannello Board thickness	Modello Model	Finitura Finishing	Imballo Packaging	Cod.
10-16	Canale Groove	Transparente / non classificata Transparent / not defined	<input type="checkbox"/>	4 UN/Ut. 7004520
10-16	Canale Groove	Transparente / non classificata Transparent / not defined	<input type="checkbox"/>	4 UN/Ut. 7004620
18	Canale Groove	Transparente / non classificata Transparent / not defined	<input type="checkbox"/>	4 UN/Ut. 7917820
10-16	Classico Classic	Transparente / non classificata Transparent / not defined	<input type="checkbox"/>	4 UN/Ut. 6009920

Acciaio, Tecnoplastica, Zama
Plastic, Steel, Zamak

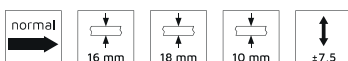

Carrello Placard per porte scorrevoli

Carriage Placard for sliding door



Modello Model	Finitura Finishing	Imballo Packaging	Cod.
Classico Classic	Verniciato nero Black painted	<input checked="" type="checkbox"/>	50 UN/Ut. 6012214
Canale Groove	Verniciato nero Black painted	<input checked="" type="checkbox"/>	50 UN/Ut. 6102114

Acciaio, Tecnoplastica
Plastic, Steel



SISTEMA PLACARD 81 // PLACARD 81 SYSTEM

Pattino Placard per porte scorrevoli

Placard roller for sliding door



Spessore pannello Board thickness	Finitura Finishing	Imballo Packaging	Cod.
10-16	Zincato bianco Zinc plated	 100 UN/Ut.	6101905
18	Zincato bianco Zinc plated	 100 UN/Ut.	6102205

Acciaio, Tecnoplastica
Plastic, Steel

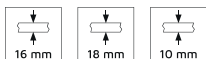

Freno Placard per porte scorrevoli

Placard brake for sliding door



Finitura Finishing	Imballo Packaging	Cod.
Plastica grigia Grey plastic	 100 UN/Ut.	6102021

Tecnoplastica
Plastic



BINARI PLACARD 81 // PLACARD 81 TRACKS

Binari superiori Placard Classico et Placard a Canale per porte scorrevoli

Classic Placard upper tracks and Placard of Groove for sliding door

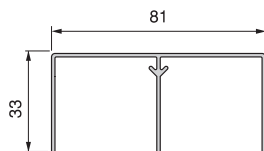
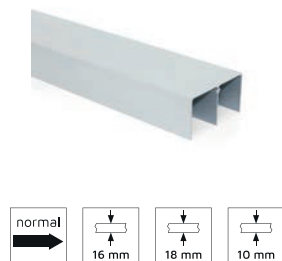

Lunghezza Longitude	Finitura Finishing	Imballo Packaging	Cod.
3,9 m	Verniciato bianco White painted	8 UN/Ut.	6907612
2,35 m	Anodizzato opaco Matt anodized	8 UN/Ut.	6301362
3,9 m	Anodizzato opaco Matt anodized	8 UN/Ut.	6907662

Alluminio
Aluminium

Binario superiore per Slowmove

Upper track for Slowmove

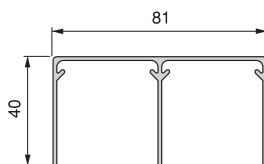
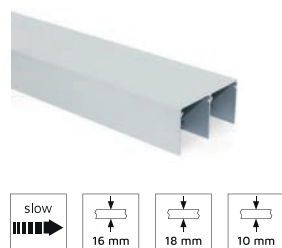

Lunghezza Longitude	Finitura Finishing	Imballo Packaging	Cod.
2,35 m	Verniciato bianco White painted	8 UN/Ut.	6300912
3,9 m	Verniciato bianco White painted	8 UN/Ut.	6118212
2,35 m	Anodizzato opaco Matt anodized	8 UN/Ut.	6300962
3,9 m	Anodizzato opaco Matt anodized	8 UN/Ut.	6118262

Alluminio
Aluminium

Binario inferiore Placard Classico per porte scorrevoli

Classic Placard lower track for sliding door

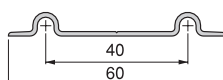
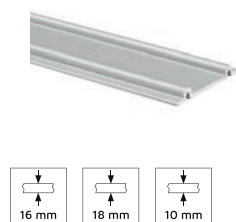

Lunghezza Longitude	Finitura Finishing	Imballo Packaging	Cod.
2,35 m	Anodizzato opaco Matt anodized	8 UN/Ut.	6304662

Alluminio
Aluminium

Profilo tappo Placard a Canale per porte scorrevoli

Profile cover Placard of Groove for sliding door

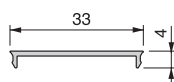
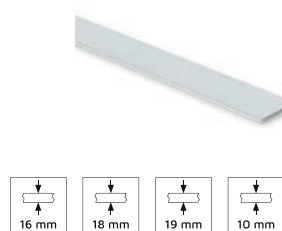

Lunghezza Longitude	Finitura Finishing	Imballo Packaging	Cod.
2,35 m	Verniciato bianco White painted	8 UN/Ut.	6104212
3,9 m	Verniciato bianco White painted	8 UN/Ut.	6907912
2,35 m	Anodizzato opaco Matt anodized	8 UN/Ut.	6104262
3,9 m	Anodizzato opaco Matt anodized	8 UN/Ut.	6907962

Alluminio
Aluminium

BINARI PLACARD 81 // PLACARD 81 TRACKS

Binario inferiore Placard a Canale per porte scorrevoli

Placard lower track of Groove for sliding door

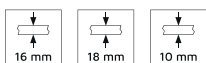
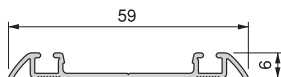

Lunghezza Longitude	Finitura Finishing	Imballo Packaging	Cod.
2,35 m	Verniciato bianco White painted	8 UN/Ut.	6307112
3,9 m	Verniciato bianco White painted	8 UN/Ut.	6907812
2,35 m	Anodizzato opaco Matt anodized	8 UN/Ut.	6307162
3,9 m	Anodizzato opaco Matt anodized	8 UN/Ut.	6907862

Alluminio
Aluminium

Binario inferiore Placard a Canale Clip per porte scorrevoli

Placard lower track of Groove Clip for sliding door

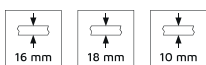
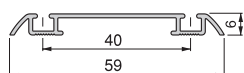

Lunghezza Longitude	Finitura Finishing	Imballo Packaging	Cod.
2,35 m	Anodizzato opaco Matt anodized	8 UN/Ut.	6304962
3,9 m	Anodizzato opaco Matt anodized	8 UN/Ut.	6032162

Alluminio
Aluminium

Binario inferiore Placard a Canale Clip

Placard lower track of Groove with Clip systems

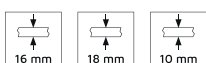
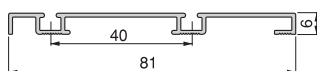

Lunghezza Longitude	Finitura Finishing	Imballo Packaging	Cod.
2,35 m	Verniciato bianco White painted	8 UN/Ut.	6305112
3,9 m	Verniciato bianco White painted	8 UN/Ut.	6907512
2,35 m	Anodizzato opaco Matt anodized	8 UN/Ut.	6305162
3,9 m	Anodizzato opaco Matt anodized	8 UN/Ut.	6907562

Alluminio
Aluminium

Clip per porte scorrevoli

Clip for sliding door



Finitura Finishing	Imballo Packaging	Cod.
Plastica nera Black plastic	25 UN/Ut.	6009017

Tecnoplastica
Plastic

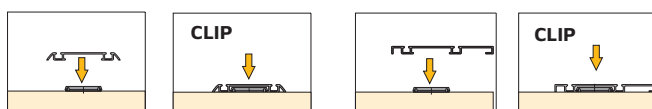

MANIGLIE PLACARD 81 // HANDLES PLACARD 81

Maniglia per armadio Style 10

Handle for wardrobe Style 10

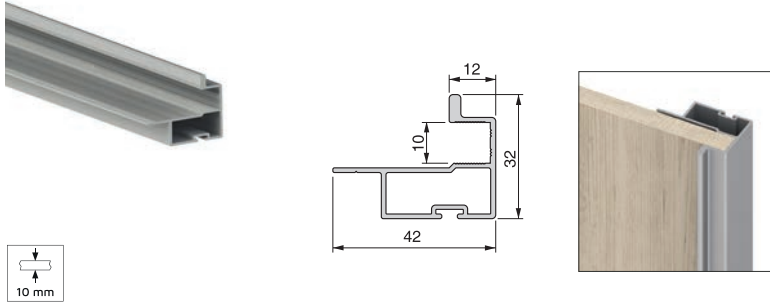

Lunghezza Longitude	Finitura Finishing	Imballo Packaging	Cod.
2,35 m	Verniciato bianco White painted	8 UN/Ut.	6302312
2,7 m	Verniciato bianco White painted	8 UN/Ut.	7005612
2,35 m	Anodizzato opaco Matt anodized	8 UN/Ut.	6302362
2,7 m	Anodizzato opaco Matt anodized	8 UN/Ut.	7005662

Alluminio
Aluminium

Maniglia per armadio Wave 10

Handle for wardrobe Wave 10

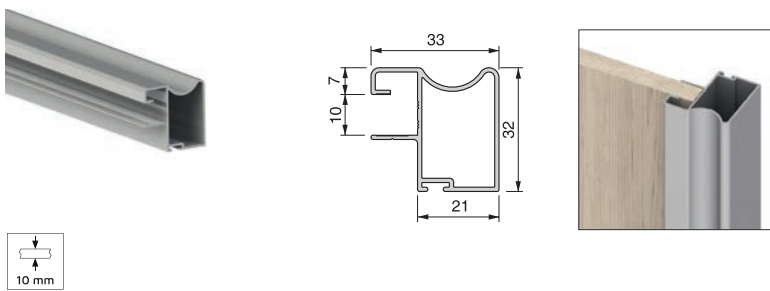

Lunghezza Longitude	Finitura Finishing	Imballo Packaging	Cod.
2,35 m	Anodizzato opaco Matt anodized	8 UN/Ut.	6305362

Alluminio
Aluminium

Maniglia per armadio Wave 16

Handle for wardrobe Wave 16

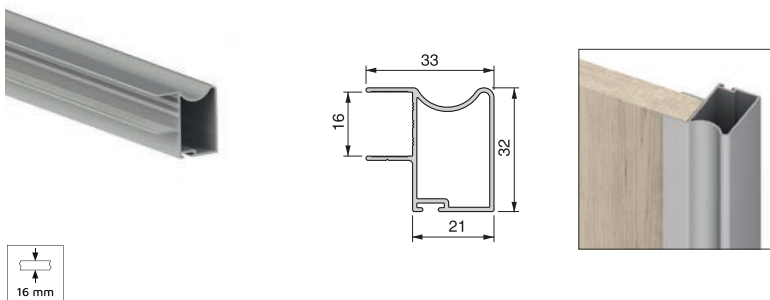

Lunghezza Longitude	Finitura Finishing	Imballo Packaging	Cod.
2,35 m	Verniciato bianco White painted	8 UN/Ut.	6302412
2,7 m	Verniciato bianco White painted	8 UN/Ut.	7005412
2,35 m	Anodizzato opaco Matt anodized	8 UN/Ut.	6302462
2,7 m	Anodizzato opaco Matt anodized	8 UN/Ut.	7005462

Alluminio
Aluminium

Maniglia per armadio Sharp 16

Handle for wardrobe Sharp 16

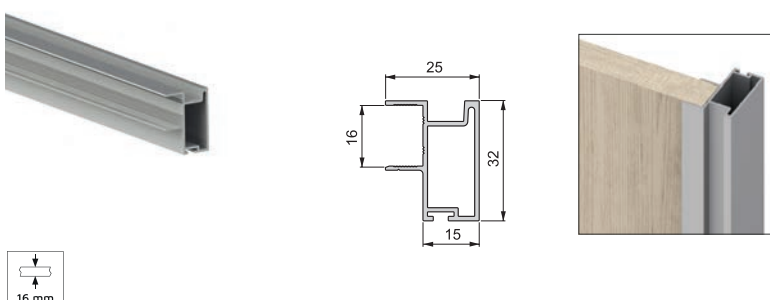

Lunghezza Longitude	Finitura Finishing	Imballo Packaging	Cod.
2,35 m	Verniciato bianco White painted	8 UN/Ut.	6303712
2,35 m	Anodizzato opaco Matt anodized	8 UN/Ut.	6303762
2,7 m	Anodizzato opaco Matt anodized	8 UN/Ut.	6013562

Alluminio
Aluminium

MANIGLIE PLACARD 81 // HANDLES PLACARD 81

Maniglia per armadio Quad 16

Handle for wardrobe Quad 16

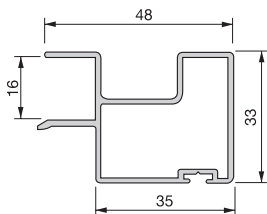

Lunghezza Longitude	Finitura Finishing	Imballo Packaging	Cod.
2,35 m	Anodizzato opaco Matt anodized	8 UN/Ut.	6302562

Alluminio Aluminium

Maniglia per armadio Wave 18

Handle for wardrobe Wave 18

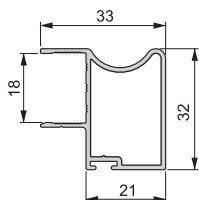
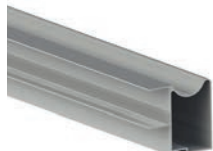

Lunghezza Longitude	Finitura Finishing	Imballo Packaging	Cod.
2,35 m	Anodizzato opaco Matt anodized	8 UN/Ut.	7014762
2,5 m	Anodizzato opaco Matt anodized	8 UN/Ut.	7017762
2,9 m	Anodizzato opaco Matt anodized	8 UN/Ut.	7917362

Alluminio Aluminium

Maniglia per armadio Deep 18

Handle for wardrobe Deep 18

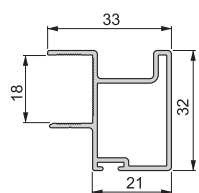
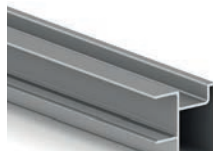

Lunghezza Longitude	Finitura Finishing	Imballo Packaging	Cod.
2,35 m	Anodizzato opaco Matt anodized	8 UN/Ut.	6303962
2,5 m	Anodizzato opaco Matt anodized	8 UN/Ut.	6018162
2,9 m	Anodizzato opaco Matt anodized	8 UN/Ut.	6018262

Alluminio Aluminium

Maniglia per armadio Quad 18

Handle for wardrobe Quad 18

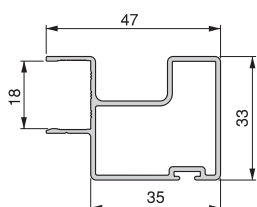
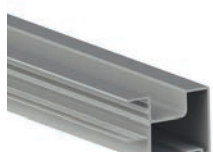

Lunghezza Longitude	Finitura Finishing	Imballo Packaging	Cod.
2,35 m	Anodizzato opaco Matt anodized	8 UN/Ut.	6302662
2,9 m	Anodizzato opaco Matt anodized	8 UN/Ut.	7918962



Alluminio Aluminium

TRAVERSI PLACARD 81 // PLACARD 81 CROSS-PIECES

Traverso Placard H10x12/22

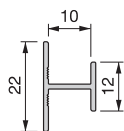
Cross-pieces Placard H10x12/22





Lunghezza Longitude	Finitura Finishing	Imballo Packaging	Cod.
2,35 m	Verniciato bianco White painted	 8 UN/Ut.	6305512
1,15 m	Anodizzato opaco Matt anodized	 8 UN/Ut.	6311862
2,35 m	Anodizzato opaco Matt anodized	 8 UN/Ut.	6305562

Alluminio
Aluminium

Traverso Placard H16x18

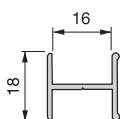
Cross-pieces Placard H16x18







Lunghezza Longitude	Finitura Finishing	Imballo Packaging	Cod.
2,35 m	Verniciato bianco White painted	 8 UN/Ut.	6300812
2,35 m	Anodizzato opaco Matt anodized	 8 UN/Ut.	6300862

Alluminio
Aluminium

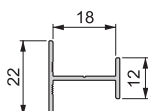
Traverso Placard H18x12/22

Cross-pieces Placard H18x12/22



Lunghezza Longitude	Finitura Finishing	Imballo Packaging	Cod.
2,35 m	Verniciato nero Black painted	 8 UN/Ut.	6305614
2,35 m	Grigio antracite Anthracite grey	 8 UN/Ut.	6305635
1,15 m	Anodizzato opaco Matt anodized	 8 UN/Ut.	6312262
2,35 m	Anodizzato opaco Matt anodized	 8 UN/Ut.	6305662

Alluminio
Aluminium

TRAVERSI PLACARD 81 // PLACARD 81 CROSS-PIECES

Traverso Placard U10x16

Crossbeams Placard U10x16

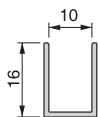

Lunghezza Longitude	Finitura Finishing	Imballo Packaging	Cod.
2,35 m	Verniciato bianco White painted		8 UN/Ut. 6302712
1,15 m	Anodizzato opaco Matt anodized		8 UN/Ut. 6311962
2,35 m	Anodizzato opaco Matt anodized		8 UN/Ut. 6302762

Alluminio
Aluminium

Traverso Placard U16x14

Crossbeams Placard U16x14

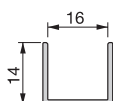

Lunghezza Longitude	Finitura Finishing	Imballo Packaging	Cod.
1,15 m	Verniciato bianco White painted		8 UN/Ut. 6312112
2,35 m	Verniciato bianco White painted		8 UN/Ut. 6300312
2,35 m	Verniciato nero Black painted		8 UN/Ut. 6300314
2,35 m	Grigio antracite Anthracite grey		8 UN/Ut. 6300335
1,15 m	Anodizzato opaco Matt anodized		8 UN/Ut. 6312162
2,35 m	Anodizzato opaco Matt anodized		8 UN/Ut. 6300362

Alluminio
Aluminium

Traverso Placard U18x14

Crossbeams Placard U18x14

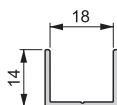

Lunghezza Longitude	Finitura Finishing	Imballo Packaging	Cod.
2,35 m	Verniciato nero Black painted		8 UN/Ut. 6305714
2,35 m	Grigio antracite Anthracite grey		8 UN/Ut. 6305735
1,15 m	Anodizzato opaco Matt anodized		8 UN/Ut. 6312362
2,35 m	Anodizzato opaco Matt anodized		8 UN/Ut. 6305762

Alluminio
Aluminium

PLACARD

90



BINARI INFERIORI E SUPERIORI

LOWER AND UPPER TRACKS

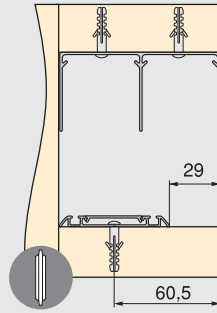

CALCOLO MISURA ANTA

HOW TO CALCULATE THE DOOR

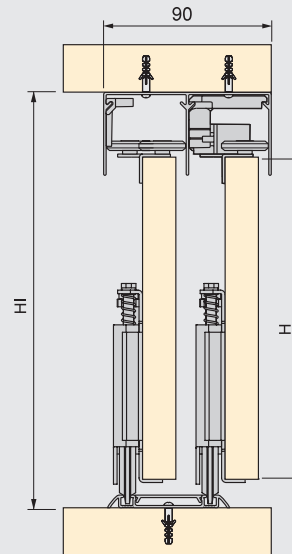
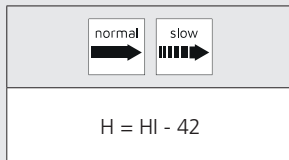

LARGHEZZA MINIMA DELLA PORTA CON SLOWMOVE

WIDTH OF THE DOOR WITH SLOWMOVE

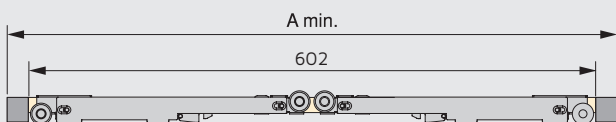

A min.	636 mm	636 mm	628 mm

MANIGLIE

HANDLES

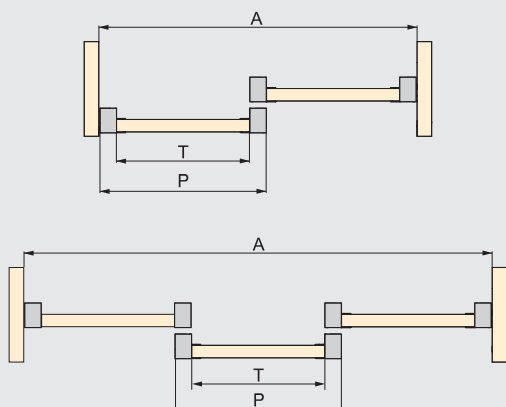

Model			
Vall	$T = \frac{A + 16}{2}$	$P = \frac{A + 28}{2}$	$T = \frac{A + 42}{3}$ $P = \frac{A + 60}{3}$
Hill	$T = \frac{A + 30}{2}$	$P = \frac{A + 34}{2}$	$T = \frac{A + 62}{3}$ $P = \frac{A + 68}{3}$
Line	$T = \frac{A + 16}{2}$	$P = \frac{A + 20}{2}$	$T = \frac{A + 34}{3}$ $P = \frac{A + 40}{3}$

SET PLACARD 90 // KIT PLACARD 90

Set di binari per Placard a Canale per porte scorrevole

Track set of Placard of Groove for sliding door



Lunghezza Longitude	Finitura Finishing	Imballo Packaging	Cod.
2,35 m	Anodizzato opaco Matt anodized	1 UN/Ut.	6118662
3,9 m	Anodizzato opaco Matt anodized	1 UN/Ut.	6032362

Alluminio
Aluminium



Set de maniglie Hill 19 per una porta scorrevole

Handle profile set Hill 19 for one sliding door



Lunghezza Longitude	Finitura Finishing	Imballo Packaging	Cod.
2,35 m	Anodizzato opaco Matt anodized	1 UN/Ut.	6104462
2,7 m	Anodizzato opaco Matt anodized	1 UN/Ut.	6104662

Alluminio, Vari
Aluminium, Various



Set de maniglie Line 19 per una porta scorrevole

Handle profile set Line 19 for one sliding door



Spessore pannello Board thickness	Lunghezza Longitude	Finitura Finishing	Imballo Packaging	Cod.
19	2,7 m	Anodizzato opaco Matt anodized	1 UN/Ut.	6311662

Alluminio
Aluminium



Set de maniglie Vall 19 per una porta scorrevole

Handle profile set Vall 19 for one sliding door



Spessore pannello Board thickness	Lunghezza Longitude	Finitura Finishing	Imballo Packaging	Cod.
19	2,7 m	Anodizzato opaco Matt anodized	1 UN/Ut.	6311762

Alluminio
Aluminium



SISTEMA PLACARD 90 // PLACARD 90 SYSTEM

Set di ferramenta per anta con Slowmove (Ammortizzatori)

Set of fittings for door with Slowmove (Soft-closing)



Spessore pannello Board thickness	Finitura Finishing	Imballo Packaging	Cod.
19	Transparente / non classificata Transparent / not defined	<input type="checkbox"/>	2 UN/Ut. 6107620
19	Transparente / non classificata Transparent / not defined	<input type="checkbox"/>	2 UN/Ut. 6107920

Tecnoplastica
Plastic

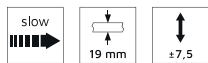

Ferramenta per una porta a Canale scorrevole

Set of fittings for sliding door of Groove



Spessore pannello Board thickness	Finitura Finishing	Imballo Packaging	Cod.
19 mm	Transparente / non classificata Transparent / not defined	<input type="checkbox"/>	4 UN/Ut. 6104520

Acciaio, Tecnoplastica
Plastic, Steel

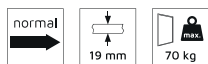

Set di ferramenta per anta con Slowmove (Carrelli)

Set of fittings for door with Slowmove (Carriage)



Modello Model	Finitura Finishing	Imballo Packaging	Cod.
Canale Groove	Transparente / non classificata Transparent / not defined	<input type="checkbox"/>	4 UN/Ut. 6108020
Classico Classic	Transparente / non classificata Transparent / not defined	<input type="checkbox"/>	4 UN/Ut. 6108120

Acciaio, Tecnoplastica
Plastic, Steel

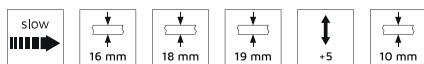

Carrello Placard per porte scorrevoli

Carriage Placard for sliding door



Modello Model	Finitura Finishing	Imballo Packaging	Cod.
Classico Classic	Verniciato nero Black painted	<input checked="" type="checkbox"/>	50 UN/Ut. 6012214
Canale Groove	Verniciato nero Black painted	<input checked="" type="checkbox"/>	50 UN/Ut. 6102114

Acciaio, Tecnoplastica
Plastic, Steel



SISTEMA PLACARD 90 // PLACARD 90 SYSTEM

Pattino Placard per porte scorrevoli

Placard roller for sliding door



Spessore pannello Board thickness	Finitura Finishing	Imballo Packaging	Cod.
19 mm	Zincato bianco Zinc plated	 100 UN/Ut.	6102605

Acciaio, Tecnoplastica
Plastic, Steel



Freno Placard per porte scorrevoli

Placard brake for sliding door



Finitura Finishing	Imballo Packaging	Cod.
Plastica grigia Grey plastic	 100 UN/Ut.	6102021

Tecnoplastica
Plastic



BINARI PLACARD 90 // PLACARD 90 TRACKS

Binario superiore per Slowmove

Upper track for Slowmove

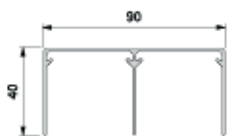

Lunghezza Longitude	Finitura Finishing	Imballo Packaging	Cod.
2,35 m	Anodizzato opaco Matt anodized	8 UN/Ut.	6306262
3,9 m	Anodizzato opaco Matt anodized	8 UN/Ut.	6032262

Alluminio
Aluminium



Binario inferiore Placard a Canale per porte scorrevoli

Placard lower track of Groove for sliding door

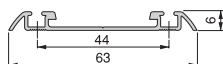

Lunghezza Longitude	Finitura Finishing	Imballo Packaging	Cod.
2,35 m	Anodizzato opaco Matt anodized	8 UN/Ut.	6304062
3,9 m	Anodizzato opaco Matt anodized	8 UN/Ut.	6032062

Alluminio
Aluminium



Profilo tappo Placard a Canale per porte scorrevoli

Profile cover Placard of Groove for sliding door

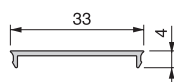

Lunghezza Longitude	Finitura Finishing	Imballo Packaging	Cod.
2,35 m	Verniciato bianco White painted	8 UN/Ut.	6104212
3,9 m	Verniciato bianco White painted	8 UN/Ut.	6907912
2,35 m	Anodizzato opaco Matt anodized	8 UN/Ut.	6104262
3,9 m	Anodizzato opaco Matt anodized	8 UN/Ut.	6907962

Alluminio
Aluminium

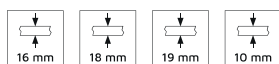

MANIGLIE PLACARD 90 // HANDLES PLACARD 90

Maniglia per armadio Vall 19

Handle for wardrobe Vall 19 handle

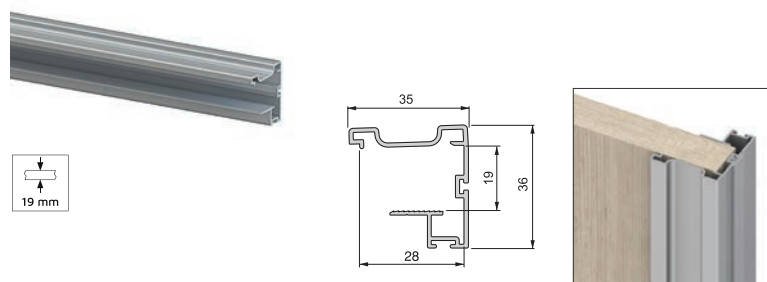

Lunghezza Longitude	Finitura Finishing	Imballo Packaging	Cod.
2,35 m	Anodizzato opaco Matt anodized	8 UN/Ut.	6307662
2,7 m	Anodizzato opaco Matt anodized	8 UN/Ut.	6016662

Alluminio Aluminium

Maniglia per armadio Hill 19

Handle for wardrobe Hill 19 handle

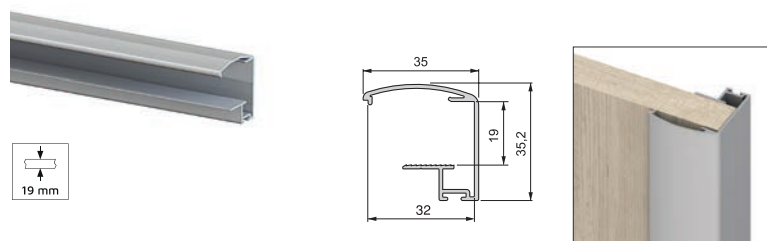

Lunghezza Longitude	Finitura Finishing	Imballo Packaging	Cod.
2,35 m	Anodizzato opaco Matt anodized	8 UN/Ut.	6306462
2,7 m	Anodizzato opaco Matt anodized	8 UN/Ut.	6016762

Alluminio Aluminium

Maniglia per armadio Line 19

Handle for wardrobe Line 19 handle

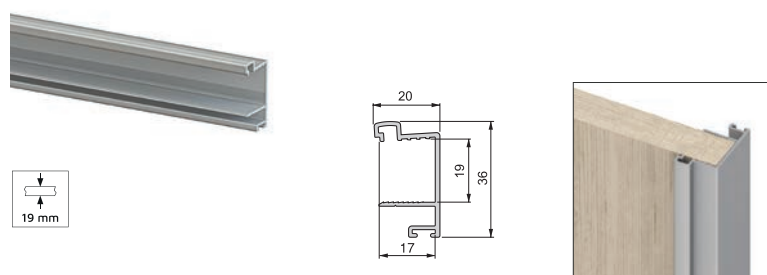

Lunghezza Longitude	Finitura Finishing	Imballo Packaging	Cod.
2,35 m	Anodizzato opaco Matt anodized	8 UN/Ut.	6306562
2,7 m	Anodizzato opaco Matt anodized	8 UN/Ut.	6016862

Alluminio Aluminium

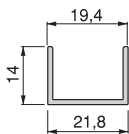
TRAVERSI PLACARD 90 // PLACARD 90 CROSS-PIECES
Traverso Placard U19x14
Crossbeams Placard U19x14

Lunghezza Longitude	Finitura Finishing	Imballo Packaging	Cod.
1,15 m	Verniciato bianco White painted	8 UN/Ut.	6312512
2,35 m	Verniciato bianco White painted	8 UN/Ut.	6103112
2,35 m	Verniciato nero Black painted	8 UN/Ut.	6103114
2,35 m	Grigio antracite Anthracite grey	8 UN/Ut.	6103135
1,15 m	Anodizzato opaco Matt anodized	8 UN/Ut.	6312562
2,35 m	Anodizzato opaco Matt anodized	8 UN/Ut.	6103162

 Alluminio
Aluminium

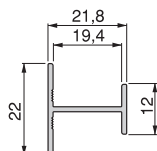
Traverso Placard H19x12/22
Crossbeams Placard H19x12/22

Lunghezza Longitude	Finitura Finishing	Imballo Packaging	Cod.
1,15 m	Verniciato bianco White painted	8 UN/Ut.	6312412
2,35 m	Verniciato bianco White painted	8 UN/Ut.	6102912
2,35 m	Verniciato nero Black painted	8 UN/Ut.	6102914
2,35 m	Grigio antracite Anthracite grey	8 UN/Ut.	6102935
1,15 m	Anodizzato opaco Matt anodized	8 UN/Ut.	6312462
2,35 m	Anodizzato opaco Matt anodized	8 UN/Ut.	6102962

 Alluminio
Aluminium

PLACARD ACCESSORIES



GLASS DOOR
CABINETS WITH SLOPING CEILING



PORTA CRISTALLO PLACARD 74 // GLASS DOOR PLACARD 74

Profilo superiore e inferiore 12+4 per porte scorrevoli in vetro

Profile upper and lower 12+4 for sliding glass doors

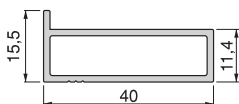

Spessore pannello Board thickness	Lunghezza Longitude	Finitura Finishing	Imballo Packaging	Cod.
16	2,35 m	Anodizzato opaco Matt anodized	8 UN/Ut.	6303262

Alluminio
Aluminium

Profili per ante Plus 14 - Profilo superiore e inferiore 14+4

Profile for cabinets Plus 14 - 14+4 upper and lower profile

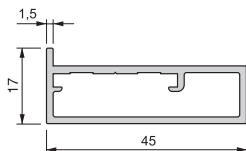

Lunghezza Longitude	Finitura Finishing	Imballo Packaging	Cod.
2,35 m	Anodizzato opaco Matt anodized	8 UN/Ut.	6304462

Alluminio
Aluminium

Ferramenta Placard Cristallo 6+4 e 12+4 per porte scorrevoli

Fittings Glass Placard 6+4 and 12+4 for sliding door

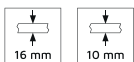

Finitura Finishing	Imballo Packaging	Cod.
Trasparente / non classificata Transparent / not defined	1 UN/Ut.	6006920

Vari
Various

Nastro adesivo per vetro Plus 14 - 15

Adhesive tape for glass Plus 14 - 15

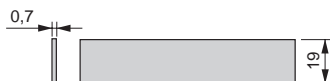
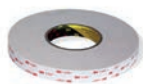

Descrizioni Description	Lunghezza Longitude	Finitura Finishing	Imballo Packaging	Cod.
Nastro adesivo per vetro Adhesive tape for glass	33 m	Plastica bianca White plastic	1 UN/Ut.	6000215

Tecnoplastica
Plastic

Guarnizione profilo Placard per cristallo

Placard glass stop profile

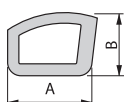

A	B	Spessore pannello Board thickness	Lunghezza Longitude	Finitura Finishing	Imballo Packaging	Cod.
12	6	10-16	32 m	Plastica grigia Grey plastic	1 UN/Ut.	4001621
14	10	18 - 19	32 m	Plastica grigia Grey plastic	1 UN/Ut.	7917121

Tecnoplastica
Plastic

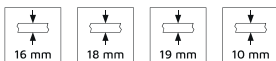

SOLUZIONE PER ARMADI CON TETTO INCLINATO 74 // SOLUTION FOR CABINETS WITH SLOPING CEILING 74

Pattino Placard per tetto inclinato

Placard skid for sloping ceiling



Finitura Finishing	Imballo Packaging	Cod.
Transparente / non classificata Transparent / not defined	1 UN/Ut.	7919020

Vari
Various

Profilo superiore e inferiore per porte scorrevoli in vetro

Upper and lower profile for sliding glass doors

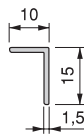

Lunghezza Longitude	Finitura Finishing	Imballo Packaging	Cod.
2,35 m	Anodizzato opaco Matt anodized	20 UN/Ut.	6303362

Alluminio
Aluminium

Modelo / Modelo	P	Y	MIN.	MAX.
 	81	98	83	98
 	74	92	77	90
 	90	98	90	98

COME ORDINARE?

HOW TO ORDER?



1 FERRAMENTA - FITTINGS

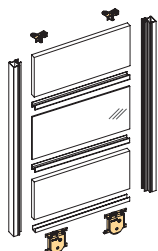

PLACARD 74



PLACARD 81



PLACARD 90



Soft close



2 BINARI INFERIORI - LOWER TRACKS

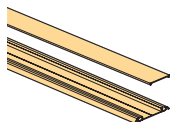

SCREW

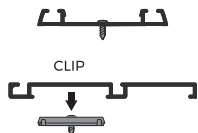

PLACARD 74



SCREW



PLACARD 81



SCREW

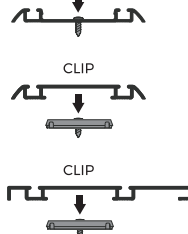

PLACARD 90



SCREW



3 BINARI SUPERIORI - UPPER TRACKS

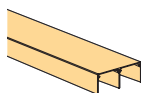

PLACARD 74

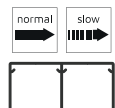

PLACARD 81

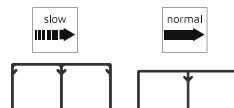

PLACARD 90

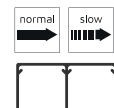

4 MANIGLIE - HANDLES

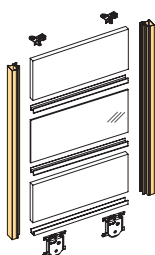

PLACARD 74

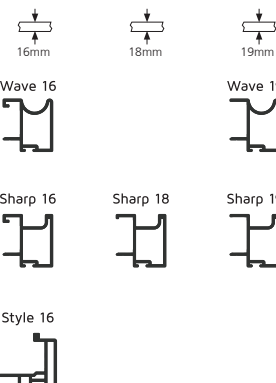

PLACARD 81

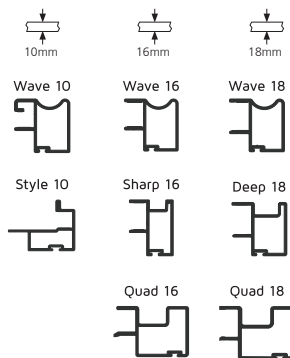

PLACARD 90

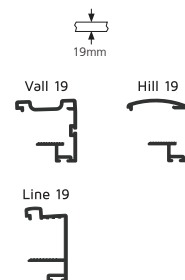

5 TRAVERSI - CROSS-PIECES.

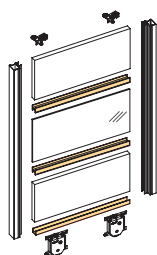

10mm

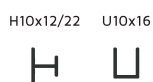

16mm

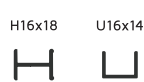

18mm

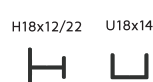

19mm

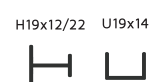





Emuca S.R.L

Via Messico, 80 • 35127 Padova (ITALIA)
T. +39 049 8702800 • F. +39 049 87 03019
www.emuca.it

Emuca Ltd.

75 Springfield Road • Chelmsford • Essex
CM2 6JG (UK)
T. +44 1268 530 674 • F. +44 1268 282 592
www.emuca.co.uk

Emuca S.A.

Pl. El Oliveral - c/H, 4 • Apartado de correos 176
46394 Riba-Roja del Túria • Valencia (ESPAÑA)
T. +34 96 166 70 19 • F. +34 96 166 71 82
www.emuca.es

Emuca S.A.R.L

Parc de l'Aubinière • 2 Avenue des Améthystes
44338 Nantes Cedex 03 (FRANCE)
T. +33 2 49 88 07 35 • F. +33 2 72 22 02 24
www.emuca.fr

Emuca Lda.

AV. da Liberdade n° 38, 4° • 1250-145 Lisboa (PORTUGAL)
T. +351 211 203 940 • F. +34 96 166 71 82
www.emuca.pt

09/2021

