

# titane

Storage for kitchens



emuca   
furniture fittings solutions







Titane corner pull-out systems / Sistemi estraibili angolari Titane  
 Sistema extraíble de rincón Titane / Système extractible d'angle Titane  
 Canto mágico Titane / Titane narożnikowe systemy wysuwne

emuca 



Cod. 	
89443	35 1
Steel and particle board	

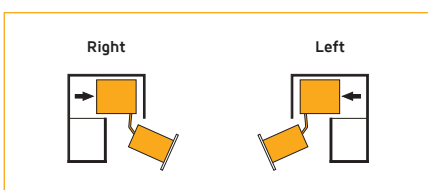
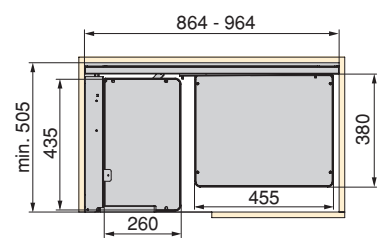
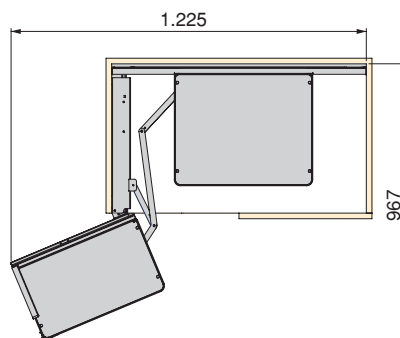
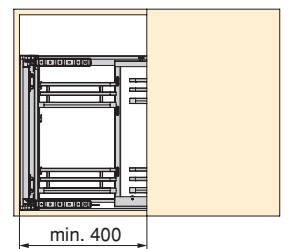
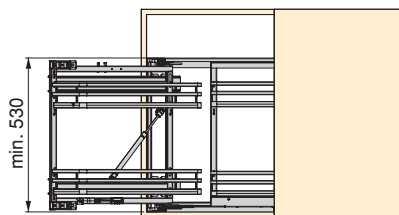

Titane bottle lateral pull-out with soft closing / Portabottiglie laterale estraibile Titane con chiusura soft  
 Botellero lateral extraíble Titane con cierre suave / Porte-bouteille latéral extractible Titane avec fermeture amortie  
 Garrafeira lateral extraível Titane com fecho suave / Titane boczny moduł wysuwny z cichym domykiem

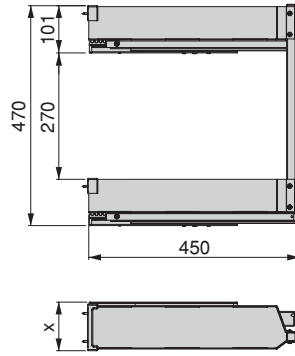

Module	X	Cod.		
150	104	<b>83590</b>	<b>35</b>	1
200	154	<b>83600</b>	<b>35</b>	1

Steel



Titane larder pull out for hinged doors / Colonna estraibile Titane per porte con cerniere  
 Columna extraíble Titane para puerta con bisagras / Colonne extractible Titane pour porte avec charnières  
 Coluna extraível Titane para porta de abrir com dobradiças / Titane cargo wysuwne do drzwi z zawiasami

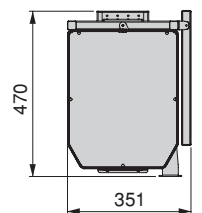
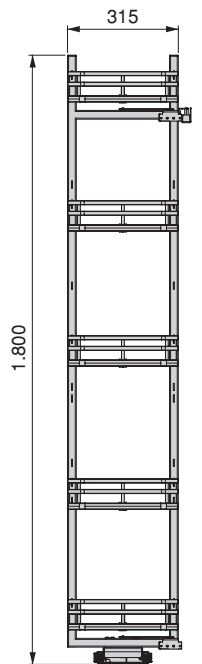

Module	Cod.		
400	<b>89451</b>	<b>35</b>	1

Steel and particle board

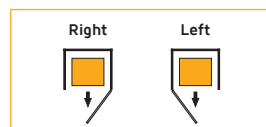

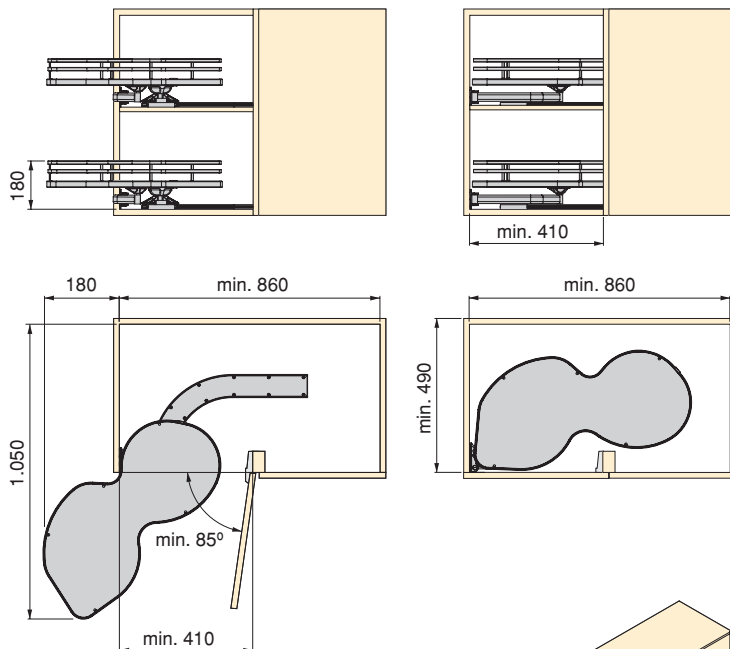
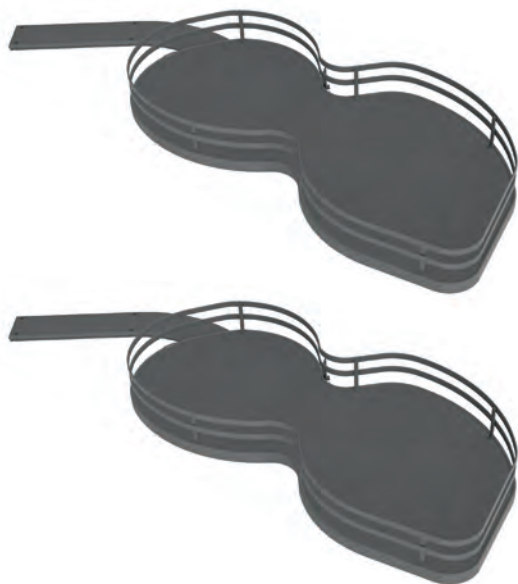

Module	Cod.		
Right	89441	35	1
Left	89442	35	1

Steel and particle board

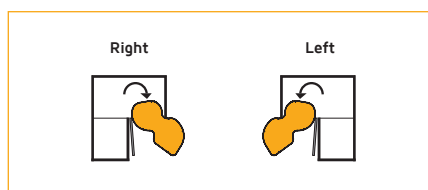

optional

Huit Titane Frame / Struttura porta ripiano Huit Titane  
 Bastidor Huit Titane / Accessoire pour meuble d'angle Huit Titane  
 Eixo de união Huit Titane / Rama Huit Titane



Module	Cod.		
Right	89444	35	1
Left	89445	35	1

Steel

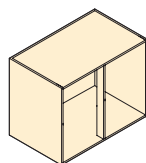
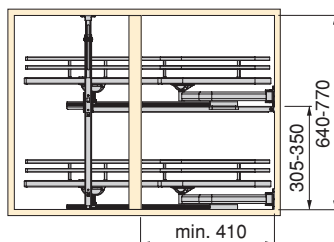

optional

Assisted open/close / Chiusura ammortizzata  
 Cierre asistido / Fermeture amortie  
 Fecho assistido / Wspomagane otwarcie/zamykanie



Cod.		
89446	20	1

Steel and plastic



#### **Emuca S.R.L**

Via Messico, 80 • 35127 Padova (ITALIA)  
T. +39 049 8702800 • F. +39 049 87 03019  
[www.emuca.it](http://www.emuca.it) • [info@emuca.com](mailto:info@emuca.com)

#### **Emuca Ltd.**

75 Springfield Road • Chelmsford • Essex  
CM2 6JG (UK)  
T. +44 1268 530 674 • F. +44 1268 282 592  
[www.emuca.co.uk](http://www.emuca.co.uk) • [sales@emuca.com](mailto:sales@emuca.com)

#### **Emuca S.A.**

Pl. El Oliveral - c/H, 4 • Apartado de correos 176  
46394 Riba-Roja del Túria • Valencia (ESPAÑA)  
T. +34 96 166 70 19 • F. +34 96 166 71 82  
[www.emuca.es](http://www.emuca.es) • [emuca@emuca.com](mailto:emuca@emuca.com)

#### **Emuca S.A.R.L**

Parc de l'Aubinière • 2 Avenue des Améthystes  
44338 Nantes Cedex 03 (FRANCE)  
T. +33 2 49 88 07 35 • F. +33 2 72 22 02 24  
[www.emuca.fr](http://www.emuca.fr) • [emuca@emuca.com](mailto:emuca@emuca.com)

#### **Emuca Lda.**

AV. da Liberdade nº 36, 6º • 01250 Lisboa (PORTUGAL)  
T. +351 211 203 940 • F. +34 96 166 71 82  
[www.emuca.pt](http://www.emuca.pt) • [emuca@emuca.com](mailto:emuca@emuca.com)

06/2018 Cod. 900816



CERTIQUALITY  
È MEMBRO DELLA  
FEDERAZIONE CISO

