

# RECYCLE

WASTE CONTAINERS . ABFALLBEHÄLTER



emuca   
where creation begins



# Index

---

**4** Recycle containers for drawers  
Recycle ehälter für Schubladen



**8** Bins for door  
Behälter für Türen



AUTOMATIC



**10** Automatic opening bins  
Selbstausziehende Boden-  
Klemmbehälter



AUTOMATIC



**12** Automatic opening bins with lower  
fastening  
Bodenmontierten Behältern mit  
manueller Entnahme



MANUAL



**14** Other waste bins  
Andere Eimer



# WASTE CONTAINERS

## ABFALLBEHÄLTER





# INFORMATION

## INFORMATIONEN

Height / Höhe		216	266
450			
500			
600			

Height / Höhe		216	266
700			
800			
900			
1.000			
1.200			



RECYCLE CONTAINERS // RECYCLE EHÄLTER FÜR SCHUBLADEN

Recycle Base for containers for kitchen drawers

Recycle-Unterlage für Recycle-Mülleimer

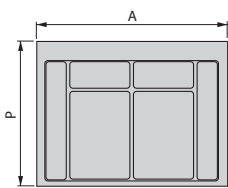

Description Beschreibung	M	A	P	Finishing Fertigstellung	Format Format	Cod.
1 cavities 1 Hohlräume	450	336 - 386	414 - 482	Anthracite grey plastic Anthrakitgrauer Kunststoff		1 UN/UN 8196523
2 cavities 2 Hohlräume	450	307 - 386	435 - 482	Anthracite grey plastic Anthrakitgrauer Kunststoff		1 UN/UN 8196623
2 cavities 2 Hohlräume	500	307 - 436	435 - 482	Anthracite grey plastic Anthrakitgrauer Kunststoff		1 UN/UN 8196823
2 cavities 2 Hohlräume	600	486 - 536	414 - 482	Anthracite grey plastic Anthrakitgrauer Kunststoff		1 UN/UN 8196923
2 cavities 2 Hohlräume	700	585 - 636	414 - 482	Anthracite grey plastic Anthrakitgrauer Kunststoff		1 UN/UN 8197023
3 cavities 3 Hohlräume	800	650 - 736	414 - 482	Anthracite grey plastic Anthrakitgrauer Kunststoff		1 UN/UN 8197123
3 cavities 3 Hohlräume	900	768 - 836	414 - 482	Anthracite grey plastic Anthrakitgrauer Kunststoff		1 UN/UN 8197223
3 cavities 3 Hohlräume	1000	885 - 936	414 - 482	Anthracite grey plastic Anthrakitgrauer Kunststoff		1 UN/UN 8197323
4 cavities 4 Hohlräume	1200	1.085 - 1.136	414 - 482	Anthracite grey plastic Anthrakitgrauer Kunststoff		1 UN/UN 8197423

Plastic  
Kunststoff

Recycle Containers for kitchen drawers, Height 266

Recycle Behälter für Küchenschublade, Höhe 266

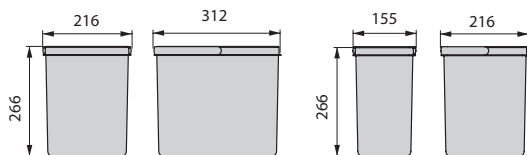

Set Stimmensatz	M	Finishing Fertigstellung	Format Format	Cod.
1x15 1x15	450 - 500	Anthracite grey plastic Anthrakitgrauer Kunststoff		1 Ut/Einh 8198123
2x15 2x15	450 - 500 - 600 - 700	Anthracite grey plastic Anthrakitgrauer Kunststoff		1 Ut/Einh 8198223
2x7 2x7	450 - 500	Anthracite grey plastic Anthrakitgrauer Kunststoff		1 Ut/Einh 8198323
1x15 + 2x7 1x15 + 2x7	450 - 500 - 600 - 700	Anthracite grey plastic Anthrakitgrauer Kunststoff		1 Ut/Einh 8198423
2x15 + 2x7 2x15 + 2x7	800 - 900 - 1000	Anthracite grey plastic Anthrakitgrauer Kunststoff		1 Ut/Einh 8198523
3x15 + 2x7 3x15 + 2x7	1200	Anthracite grey plastic Anthrakitgrauer Kunststoff		1 Ut/Einh 8198623

Plastic  
Kunststoff

Recycle Containers for kitchen drawers, Height 216

Recycle Behälter für Küchenschublade, Höhe 216

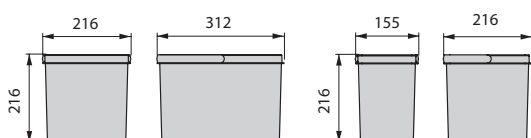

Set Stimmensatz	M	Finishing Fertigstellung	Format Format	Cod.
1x12 1x12	450 - 500	Anthracite grey plastic Anthrakitgrauer Kunststoff		1 Ut/Einh 8197523
2x12 2x12	450 - 500 - 600 - 700	Anthracite grey plastic Anthrakitgrauer Kunststoff		1 Ut/Einh 8197623
2x6 2x6	450 - 500	Anthracite grey plastic Anthrakitgrauer Kunststoff		1 Ut/Einh 8197723
1x12 + 2x6 1x12 + 2x6	450 - 500 - 600 - 700	Anthracite grey plastic Anthrakitgrauer Kunststoff		1 Ut/Einh 8197823
2x12 + 2x6 2x12 + 2x6	800 - 900 - 1000	Anthracite grey plastic Anthrakitgrauer Kunststoff		1 Ut/Einh 8197923
3x12 + 2x6 3x12 + 2x6	1200	Anthracite grey plastic Anthrakitgrauer Kunststoff		1 Ut/Einh 8198023

Plastic  
Kunststoff







**BINS FOR DOOR // BEHÄLTER FÜR TÜREN**

Recycle recycling bin for fastening to door with container 15 litres

Recycle-Mülleimer Recycle mit Befestigung an Türe mit Behälter 15 Liter

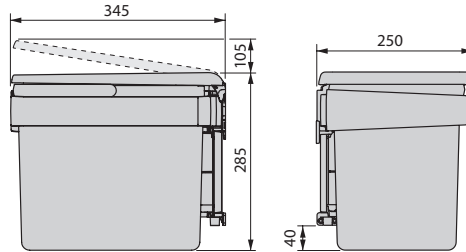

Finishing Fertigstellung	Format Format	Cod.
Anthracite grey plastic Anthrazitgrauer Kunststoff	1 Ut/Einh	8199123

Plastic  
Kunststoff

Recycling bin for fastening to door with container 13 litres

Mülleimer Recycle mit Befestigung an Türe mit Behälter 13 Liter

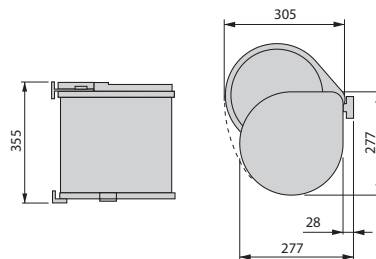

Finishing Fertigstellung	Format Format	Cod.
White plastic Weißer Kunststoff	1 Ut/Einh	8035815
Grey plastic Grau	1 Ut/Einh	8035821
Stainless steel Edelstahl	1 Ut/Einh	8035865

Plastic, Stainless steel  
Edelstahl, Kunststoff

Recycling bin for bottom fastening and manual extraction with 1 16-litre container and an automatic lid

Recycle-Mülleimer mit unterseitiger Befestigung und manuellem Auszug mit 1 Eimer an 16 Litern und automatischem Deckel

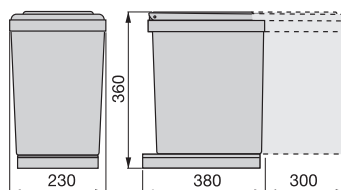

Finishing Fertigstellung	Format Format	Cod.
Grey plastic Grau	1 Ut/Einh	8906621

Plastic  
Kunststoff



**AUTOMATIC OPENING BINS**  
**SELBSTAUSZIEHENDE BODEN-KLEMMBEHÄLTER**

Recycling bin for bottom fastening and automatic extraction with 2 containers with 14 litres

Recycle-Mülleimer mit unterseitiger Befestigung und automatischem Auszug mit 2 Eimern an je 14 Litern

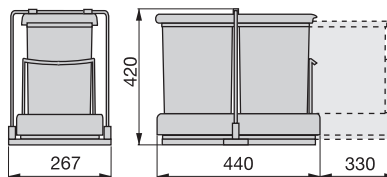

Finishing Fertigstellung	Format Format	Cod.
Grey plastic Grau	1 Ut/Einh	8077221

Plastic  
Kunststoff

Waste containers 2 inner bins (16 litres) inox

Recycle-Mülleimer mit 2x16 Liter inox

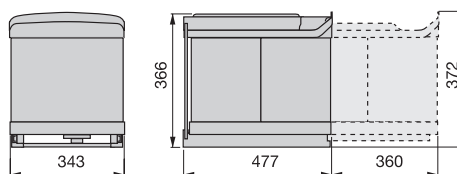

Finishing Fertigstellung	Format Format	Cod.
Stainless steel Edelstahl	1 Ut/Einh	8906865

Plastic, Stainless steel  
Edelstahl, Kunststoff

Waste containers 1 inner bin (16 litres) and 2 inner bins (7,5 litres) inox

Recycle-Mülleimer mit 1x16 Liter und 2x7,5 Liter

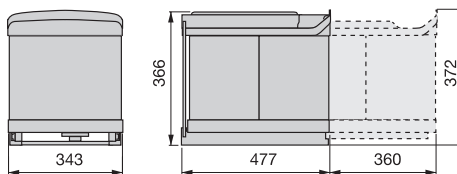

Finishing Fertigstellung	Format Format	Cod.
Grey plastic Grau	1 Ut/Einh	8038221

Plastic  
Kunststoff

**AUTOMATIC OPENING BINS WITH LOWER FASTENING**  
**BODENMONTIERTEN BEHÄLTERN MIT MANUELLER ENTNAHME**

Recycle Recycling bins for kitchen, 20 x 20 L, lower fixing and manual removal.

Recycle Recyclingbehälter für Küche, 2 x 20 L, Unterseitigbefestigung und manuelle Extraktion.



Finishing Fertigstellung	Format Format	Cod.
Anthracite grey plastic Anthrazitgrauer Kunststoff	1 Ut/Einh	8199423

Plastic  
Kunststoff

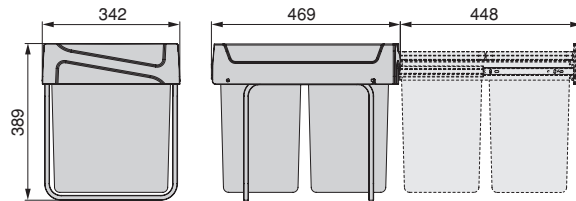

Recycling bins for kitchen, 2 x 15 L, lower fixing and manual removal.

Recyclingbehälter für Küche, 2 x 15 L, Unterseitigbefestigung und manuelle Extraktion.



Finishing Fertigstellung	Format Format	Cod.
Anthracite grey plastic Anthrazitgrauer Kunststoff	1 Ut/Einh	8199523

Plastic  
Kunststoff

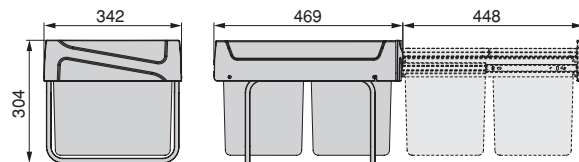

Recycle 20L Recycling bin for kitchen, lower fixing and manual removal.

Recycle 20L Recyclingbehälter für Küche, Unterseitigbefestigung und manuelle Extraktion.



Finishing Fertigstellung	Format Format	Cod.
Anthracite grey plastic Anthrazitgrauer Kunststoff	1 Ut/Einh	8199323

Plastic  
Kunststoff

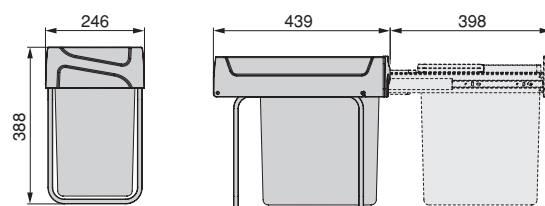





OTHER WASTE BINS // ANDERE EIMER

Circular outdoor Recycle garbage can with motion sensor opening

Runder Recycling-Container für den Außenbereich mit Bewegungssensoröffnung

Finishing Fertigstellung	Format Format	Cod.
Stainless steel Edelstahl	1 Ut/Einh	8200965

Steel  
Stahl

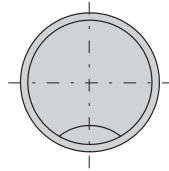
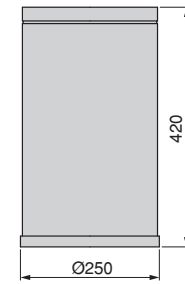

OTHER WASTE BINS // ANDERE EIMER

Pedal-opening rectangular outdoor Recycle garbage can

Rechteckiger Recycling-Container für den Außenbereich mit Pedalöffnung

Finishing Fertigstellung	Format Format	Cod.
White painted Weiß	1 Ut/Einh	8200812
		Aluminium Aluminium

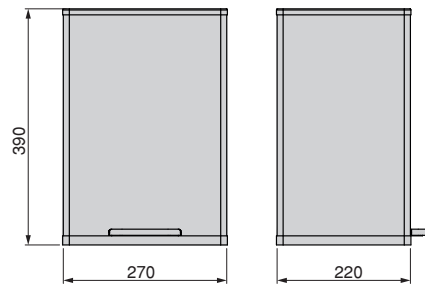

OTHER WASTE BINS // ANDERE EIMER

Recycle built-in waste bin for kitchen worktop

Recycle eingebauter Mülleimer für Küchenarbeitsplatte

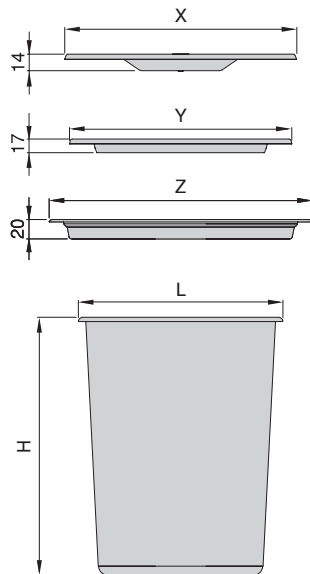

Description Beschreibung	Finishing Fertigstellung	Format Format	Cod.
6 liters 6 Liter	Stainless steel Edelstahl	1 Ut/Einh	8199665
8 liters 8 Liter	Stainless steel Edelstahl	1 Ut/Einh	8199265

Plastic, Stainless steel  
Edelstahl, Kunststoff

desc.	X	Y	Z	L	H
6 L	210	200	240	200	220
8 L	238	228	270	210	265





OTHER WASTE BINS // ANDERE EIMER

Recycle Inox bin with compartments

Recycle Inox Abfallbehälter mit Fächern



Set Stimmensatz	L	Finishing Fertigstellung	Format Format	Cod.
3x9	9	Stainless steel Edelstahl	1 Ut/Einh	8200165
3x15 3x15	15	Stainless steel Edelstahl	1 Ut/Einh	8200265
2x15 2x15	15	Stainless steel Edelstahl	1 Ut/Einh	8200365

Stainless steel  
Edelstahl

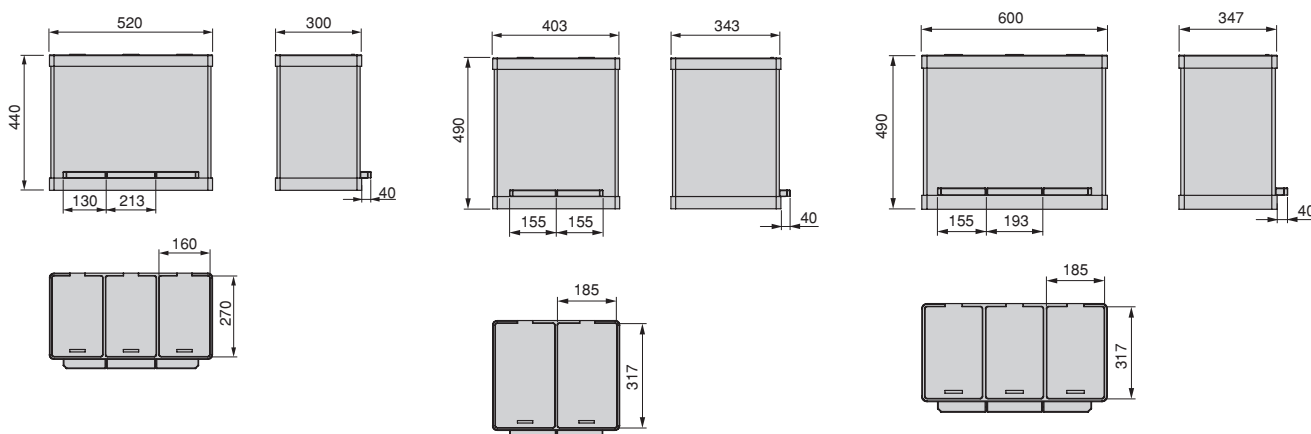





**Emuca S.R.L**

Via Messico, 80 • 35127 Padova (ITALIA)  
T. +39 049 8702800 • F. +39 049 87 03019  
[www.emuca.it](http://www.emuca.it)

**Emuca Ltd.**

75 Springfield Road • Chelmsford • Essex  
CM2 6JG (UK)  
T. +44 1268 530 674 • F. +44 1268 282 592  
[www.emuca.co.uk](http://www.emuca.co.uk)

**Emuca S.A.**

Pl. El Oliveral - c/H, 4 • Apartado de correos 176  
46394 Riba-Roja del Túria • Valencia (ESPAÑA)  
T. +34 96 166 70 19 • F. +34 96 166 71 82  
[www.emuca.es](http://www.emuca.es)

**Emuca S.A.R.L**

Parc de l'Aubinière • 2 Avenue des Améthystes  
44338 Nantes Cedex 03 (FRANCE)  
T. +33 2 49 88 07 35 • F. +33 2 72 22 02 24  
[www.emuca.fr](http://www.emuca.fr)

**Emuca Lda.**

AV. da Liberdade nº 38, 4º • 1250-145 Lisboa (PORTUGAL)  
T. +351 211 203 940 • F. +34 96 166 71 82  
[www.emuca.pt](http://www.emuca.pt)

