

DRAWER

SZUFLADA



Drawer

	Vertex drawer
17	Concept Vertex Industrial Packaging
22	Vertex drawer kit
30	Accessories Vertex
	Concept drawer
35	Concept Drawer Industrial Packaging
38	Concept drawer kit
40	Accessories Concept
	Vantage-Q Drawer
49	Compositions Vantage-Q
51	Drawer Vantage-Q kit
52	Compositions square railing
55	Compositions round railing
57	Accessories Vantage-Q
	Ultrabox Drawer
61	Ultrabox drawer
	Accessories for drawer
65	Under-sink insert

Szuflada

	Szuflada Vertex
17	Szuflada Vertex Opakowanie Zbiorcze
22	Zestaw szuflada Vertex
30	Akcesoria Vertex
	Szuflada Concept
35	Szuflada Concept Opakowanie Zbiorcze
38	Zestaw szuflada Concept
40	Akcesoria Concept
	Szuflada Vantage-Q
49	Elementy Vantage-Q
51	Zestaw szuflada Vantage-Q
52	Układy z kwadratowych relingów
55	Układy z okrągłych relingów
57	Akcesoria Vantage-Q
	Szuflada Ultrabox
61	Szuflada Ultrabox
	Akcesoria do szuflada
65	Ośłona syfonu

VERTEX

VERTEX









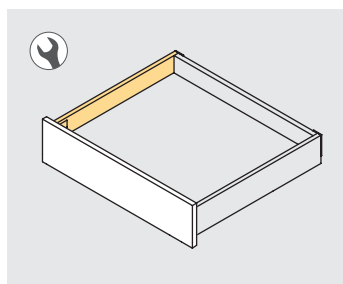

CONCEPT VERTEX INDUSTRIAL PACKAGING // SZUFLADA VERTEX OPAKOWANIE ZBIORCZE

Vertex metal sides height 93 mm LEFT

Bok do szuflady Vertex o wysokości 93 mm LEWY









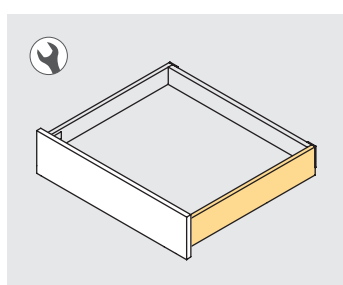

Depth Głębokość	Finishing Wykończenie	Format Format	Cod.
350	White painted Malowane na biało		20 Ut/Szt 3180212
400	White painted Malowane na biało		20 Ut/Szt 3184212
450	White painted Malowane na biało		20 Ut/Szt 3180612
500	White painted Malowane na biało		20 Ut/Szt 3180812
350	Anthracite grey Szary antracyt		20 Ut/Szt 3180235
400	Anthracite grey Szary antracyt		20 Ut/Szt 3184235
450	Anthracite grey Szary antracyt		20 Ut/Szt 3180635
500	Anthracite grey Szary antracyt		20 Ut/Szt 3180835

Steel
Stal

Vertex metal sides height 93 mm RIGHT

Bok do szuflady Vertex o wysokości 93 mm PRAWY



Depth Głębokość	Finishing Wykończenie	Format Format	Cod.
350	White painted Malowane na biało		20 Ut/Szt 3180312
400	White painted Malowane na biało		20 Ut/Szt 3184312
450	White painted Malowane na biało		20 Ut/Szt 3180712
500	White painted Malowane na biało		20 Ut/Szt 3180912
350	Anthracite grey Szary antracyt		20 Ut/Szt 3180335
400	Anthracite grey Szary antracyt		20 Ut/Szt 3184335
450	Anthracite grey Szary antracyt		20 Ut/Szt 3180735
500	Anthracite grey Szary antracyt		20 Ut/Szt 3180935

Steel
Stal

Vertex metal sides height 131 mm LEFT

Bok do szuflady Vertex o wysokości 131 mm LEWY

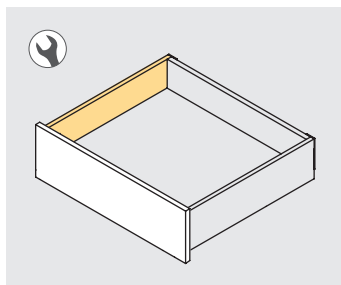

Depth Głębokość	Finishing Wykończenie	Format Format	Cod.
350	White painted Malowane na biało		20 Ut/Szt 3181612
400	White painted Malowane na biało		20 Ut/Szt 3184412
450	White painted Malowane na biało		20 Ut/Szt 3182012
500	White painted Malowane na biało		20 Ut/Szt 3182212
350	Anthracite grey Szary antracyt		20 Ut/Szt 3181635
400	Anthracite grey Szary antracyt		20 Ut/Szt 3184435
450	Anthracite grey Szary antracyt		20 Ut/Szt 3182035
500	Anthracite grey Szary antracyt		20 Ut/Szt 3182235

Steel
Stal

Vertex metal sides height 131 mm RIGHT

Bok do szuflady Vertex o wysokości 131 mm PRAWY

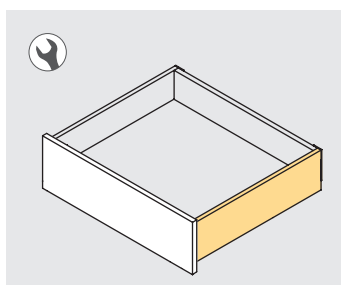

Depth Głębokość	Finishing Wykończenie	Format Format	Cod.
350	White painted Malowane na biało		20 Ut/Szt 3181712
400	White painted Malowane na biało		20 Ut/Szt 3184512
450	White painted Malowane na biało		20 Ut/Szt 3182112
500	White painted Malowane na biało		20 Ut/Szt 3182312
350	Anthracite grey Szary antracyt		20 Ut/Szt 3181735
400	Anthracite grey Szary antracyt		20 Ut/Szt 3184535
450	Anthracite grey Szary antracyt		20 Ut/Szt 3182135
500	Anthracite grey Szary antracyt		20 Ut/Szt 3182335







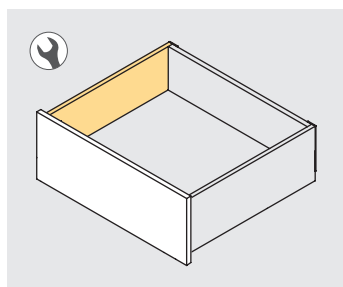

Steel
Stal

CONCEPT VERTEX INDUSTRIAL PACKAGING // SZUFLADA VERTEX OPAKOWANIE ZBIORCZE

Vertex metal sides height 178 mm LEFT

Bok do szuflady Vertex o wysokości 178 mm LEWY









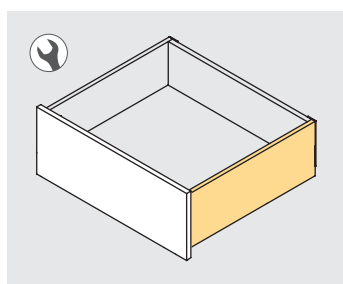

Depth Głębokość	Finishing Wykończenie	Format Format	Cod.
350	White painted Malowane na biało		10 Ut/Szt 3183012
400	White painted Malowane na biało		10 Ut/Szt 3184612
450	White painted Malowane na biało		10 Ut/Szt 3183412
500	White painted Malowane na biało		10 Ut/Szt 3183612
350	Anthracite grey Szary antracyt		10 Ut/Szt 3183035
400	Anthracite grey Szary antracyt		10 Ut/Szt 3184635
450	Anthracite grey Szary antracyt		10 Ut/Szt 3183435
500	Anthracite grey Szary antracyt		10 Ut/Szt 3183635

Steel
Stal

Vertex metal sides height 178 mm RIGHT

Bok do szuflady Vertex o wysokości 178 mm PRAWY



Depth Głębokość	Finishing Wykończenie	Format Format	Cod.
350	White painted Malowane na biało		10 Ut/Szt 3183112
400	White painted Malowane na biało		10 Ut/Szt 3183712
450	White painted Malowane na biało		10 Ut/Szt 3184712
500	White painted Malowane na biało		10 Ut/Szt 3183512
350	Anthracite grey Szary antracyt		10 Ut/Szt 3183135
400	Anthracite grey Szary antracyt		10 Ut/Szt 3184735
450	Anthracite grey Szary antracyt		10 Ut/Szt 3183535
500	Anthracite grey Szary antracyt		10 Ut/Szt 3183735

Steel
Stal

Vertex 40 kg runner slides with soft closing LEFT

Prowadnica szuflady Vertex 40 kg z cichym domykaniem LEWY

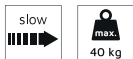

Depth Głębokość	Finishing Wykończenie	Format Format	Cod.
350	Zinc plated Cynkowane	20 Ut/Szt	3177405
400	Zinc plated Cynkowane	20 Ut/Szt	3177605
450	Zinc plated Cynkowane	20 Ut/Szt	3177805
500	Zinc plated Cynkowane	20 Ut/Szt	3178005

Steel
Stal

Vertex 40 kg runner slides with soft closing RIGHT

Prowadnica Vertex 40 kg z cichym domykaniem PRAWY



Depth Głębokość	Finishing Wykończenie	Format Format	Cod.
350	Zinc plated Cynkowane	20 Ut/Szt	3177505
400	Zinc plated Cynkowane	20 Ut/Szt	3177705
450	Zinc plated Cynkowane	20 Ut/Szt	3177905
500	Zinc plated Cynkowane	20 Ut/Szt	3178105

Steel
Stal

Kit of front clip for drawer

Zestaw zacisków do szuflad

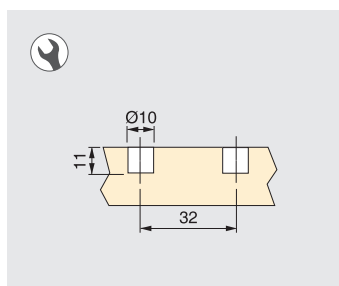

Description Opis	Finishing Wykończenie	Format Format	Cod.
Screw-on Przykręcane	Zinc plated Cynkowane	100 Pair/Kpl.	3104005
Knock-in Ø10 x 11 Wciskane Ø10 x 11	Zinc plated Cynkowane	100 Pair/Kpl.	3104105

Steel
Stal

Kit of front clip height 178 mm

Zestaw haczyków do szuflady Vertex o wysokości 178 mm

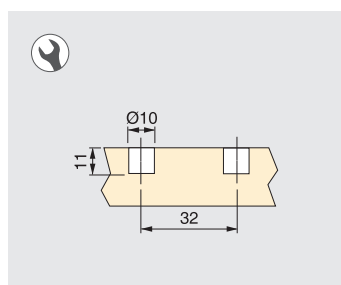

Description Opis	Finishing Wykończenie	Format Format	Cod.
Screw-on Przykręcane	Zinc plated Cynkowane	50 Pair/Kpl.	3176005
Knock-in Ø10 x 11 Wciskane Ø10 x 11	Zinc plated Cynkowane	50 Pair/Kpl.	3176105

Steel
Stal



Vertex drawer // Szuflada Vertex

VERTEX DRAWER KIT // ZESTAW SZUFLADA VERTEX

Vertex 40 kg exterior drawer height 83 mm

Szuflada zewnętrzna Vertex 40 kg, wysokość 83 mm



Depth Głębokość	Finishing Wykończenie	Format Format	Cod.
450	White painted Malowane na biało		1 KIT/Zestaw 3169912
500	White painted Malowane na biało		1 KIT/Zestaw 3170012
450	Anthracite grey Szary antracyt		1 KIT/Zestaw 3169935
500	Anthracite grey Szary antracyt		1 KIT/Zestaw 3170035

Steel
Stal

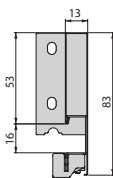
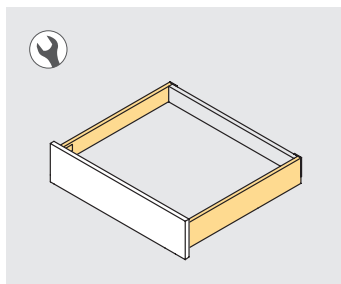

Vertex 40 kg exterior drawer height 93 mm

Szuflada zewnętrzna Vertex 40 kg, wysokość 93 mm



Depth Głębokość	Finishing Wykończenie	Format Format	Cod.
300	White painted Malowane na biało		1 KIT/Zestaw 3170212
350	White painted Malowane na biało		1 KIT/Zestaw 3170312
400	White painted Malowane na biało		1 KIT/Zestaw 3170412
450	White painted Malowane na biało		1 KIT/Zestaw 3170512
500	White painted Malowane na biało		1 KIT/Zestaw 3170612
550	White painted Malowane na biało		1 KIT/Zestaw 3170712
300	Anthracite grey Szary antracyt		1 KIT/Zestaw 3170235
350	Anthracite grey Szary antracyt		1 KIT/Zestaw 3170335
400	Anthracite grey Szary antracyt		1 KIT/Zestaw 3170435
450	Anthracite grey Szary antracyt		1 KIT/Zestaw 3170535
500	Anthracite grey Szary antracyt		1 KIT/Zestaw 3170635
550	Anthracite grey Szary antracyt		1 KIT/Zestaw 3170735

Steel
Stal

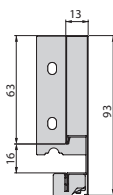
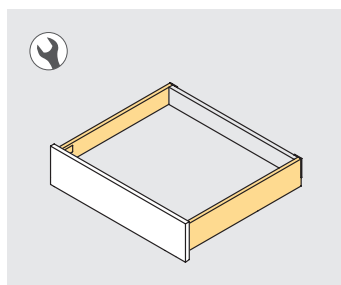

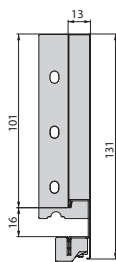
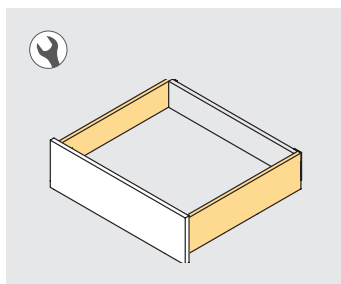
VERTEX DRAWER KIT // ZESTAW SZUFLADA VERTEX
Vertex 40 kg exterior drawer height 131 mm
Szuflada zewnętrzna Vertex 40 kg, wysokość 131 mm

Depth Głębokość	Finishing Wykończenie	Format Format	Cod.
300	White painted Malowane na biało	1 KIT/Zestaw	3170912
350	White painted Malowane na biało	1 KIT/Zestaw	3171012
400	White painted Malowane na biało	1 KIT/Zestaw	3171112
450	White painted Malowane na biało	1 KIT/Zestaw	3171212
500	White painted Malowane na biało	1 KIT/Zestaw	3171312
300	Anthracite grey Szary antracyt	1 KIT/Zestaw	3170935
350	Anthracite grey Szary antracyt	1 KIT/Zestaw	3171035
400	Anthracite grey Szary antracyt	1 KIT/Zestaw	3171135
450	Anthracite grey Szary antracyt	1 KIT/Zestaw	3171235
500	Anthracite grey Szary antracyt	1 KIT/Zestaw	3171335

 Steel
Stal

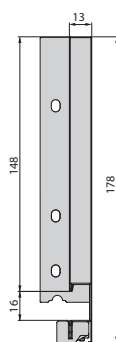
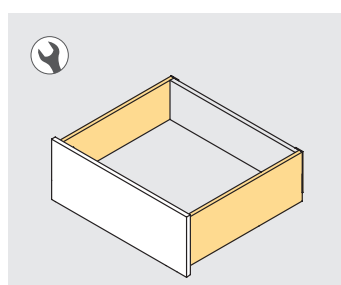
Vertex 40 kg exterior drawer height 178 mm
Szuflada zewnętrzna Vertex 40 kg, wysokość 178 mm

Depth Głębokość	Finishing Wykończenie	Format Format	Cod.
350	White painted Malowane na biało	1 KIT/Zestaw	3171612
400	White painted Malowane na biało	1 KIT/Zestaw	3171712
450	White painted Malowane na biało	1 KIT/Zestaw	3171812
500	White painted Malowane na biało	1 KIT/Zestaw	3171912
350	Anthracite grey Szary antracyt	1 KIT/Zestaw	3171635
400	Anthracite grey Szary antracyt	1 KIT/Zestaw	3171735
450	Anthracite grey Szary antracyt	1 KIT/Zestaw	3171835
500	Anthracite grey Szary antracyt	1 KIT/Zestaw	3171935

 Steel
Stal

VERTEX DRAWER KIT // ZESTAW SZUFLADA VERTEX

Vertex drawer kit for kitchen or bathroom, 93 mm height with included boards

Zestaw szuflady do kuchni lub łazienki Vertex, o wysokości 93 mm, dostarczana wraz z płytami



Width Szerokość	Depth Głębokość	Finishing Wykończenie	Format Format	Cod.
450	500	White painted Malowane na biało	1 KIT/Zestaw	3173012
600	500	White painted Malowane na biało	1 KIT/Zestaw	3173112
900	500	White painted Malowane na biało	1 KIT/Zestaw	3173212
450	500	Anthracite grey Szary antracyt	1 KIT/Zestaw	3173035
600	500	Anthracite grey Szary antracyt	1 KIT/Zestaw	3173135
900	500	Anthracite grey Szary antracyt	1 KIT/Zestaw	3173235

Various
Różne

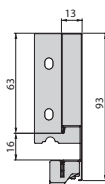
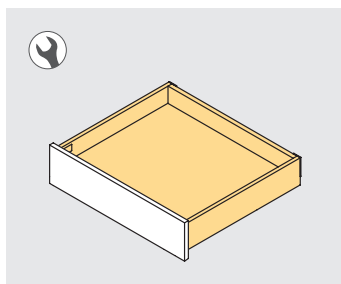

Vertex drawer kit for kitchen or bathroom, 178 mm height with included boards

Zestaw szuflady do kuchni lub łazienki Vertex, o wysokości 178 mm, dostarczana wraz z płytami



Width Szerokość	Depth Głębokość	Finishing Wykończenie	Format Format	Cod.
450	500	White painted Malowane na biało	1 KIT/Zestaw	3173312
600	500	White painted Malowane na biało	1 KIT/Zestaw	3173412
900	500	White painted Malowane na biało	1 KIT/Zestaw	3173512
450	500	Anthracite grey Szary antracyt	1 KIT/Zestaw	3173335
600	500	Anthracite grey Szary antracyt	1 KIT/Zestaw	3173435
900	500	Anthracite grey Szary antracyt	1 KIT/Zestaw	3173535

Various
Różne

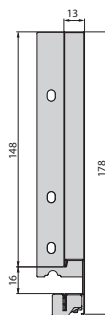
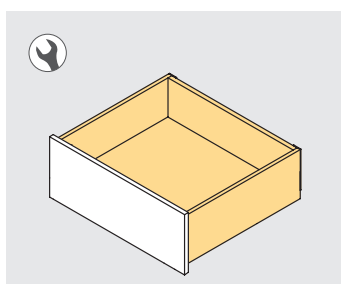







Vertex drawer // Szuflada Vertex

VERTEX DRAWER KIT // ZESTAW SZUFLADA VERTEX

Vertex exterior drawer height 93 mm with push to open

Szuflada zewnętrzna Vertex 93 mm z mechanizmem dociskowym

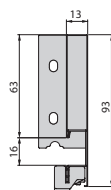
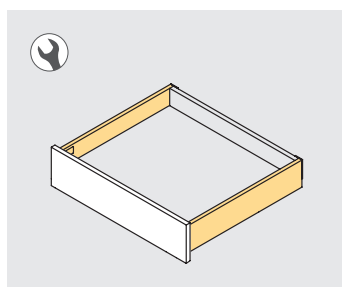

Depth Głębokość	Finishing Wykończenie	Format Format	Cod.
350	White painted Malowane na biało	1 KIT/KIT	3197012
400	White painted Malowane na biało	1 KIT/KIT	3197112
450	White painted Malowane na biało	1 KIT/KIT	3197212
500	White painted Malowane na biało	1 KIT/KIT	3197312
350	Anthracite grey Szary antracyt	1 KIT/KIT	3197035
400	Anthracite grey Szary antracyt	1 KIT/KIT	3197135
450	Anthracite grey Szary antracyt	1 KIT/KIT	3197235
500	Anthracite grey Szary antracyt	1 KIT/KIT	3197335

Various
Różne

Vertex exterior drawer height 131 mm with push to open

Szuflada zewnętrzna Vertex 131 mm z mechanizmem dociskowym

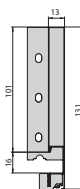
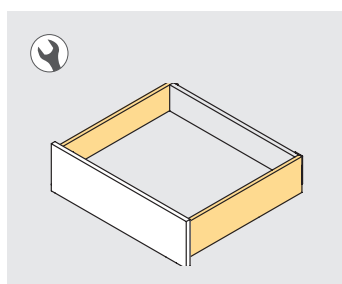

Depth Głębokość	Finishing Wykończenie	Format Format	Cod.
350	White painted Malowane na biało	1 KIT/KIT	3197412
400	White painted Malowane na biało	1 KIT/KIT	3197512
450	White painted Malowane na biało	1 KIT/KIT	3197612
500	White painted Malowane na biało	1 KIT/KIT	3197712
350	Anthracite grey Szary antracyt	1 KIT/KIT	3197435
400	Anthracite grey Szary antracyt	1 KIT/KIT	3197535
450	Anthracite grey Szary antracyt	1 KIT/KIT	3197635
500	Anthracite grey Szary antracyt	1 KIT/KIT	3197735

Various
Różne

VERTEX DRAWER KIT // ZESTAW SZUFLADA VERTEX

Vertex exterior drawer height 178 mm with push to open

Szuflada zewnętrzna Vertex 178 mm z mechanizmem dociskowym

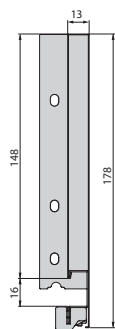
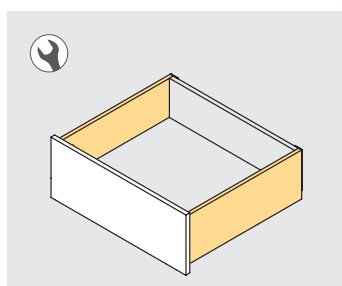

Depth Głębokość	Finishing Wykończenie	Format Format	Cod.
350	White painted Malowane na biało	1 KIT/KIT	3197812
400	White painted Malowane na biało	1 KIT/KIT	3197912
450	White painted Malowane na biało	1 KIT/KIT	3198012
500	White painted Malowane na biało	1 KIT/KIT	3198112
350	Anthracite grey Szary antracyt	1 KIT/KIT	3197835
400	Anthracite grey Szary antracyt	1 KIT/KIT	3197935
450	Anthracite grey Szary antracyt	1 KIT/KIT	3198035
500	Anthracite grey Szary antracyt	1 KIT/KIT	3198135

Various
Różne

Synchronizer set for push to open slides for Vertex drawer

Synchronizator ustawiony pod kątem prowadnic działających Push to open do szuflad Vertex



Finishing Wykończenie	Format Format	Cod.
Natural aluminium Aluminium naturalne	10 UN/UN	3198261

Aluminium
Aluminium

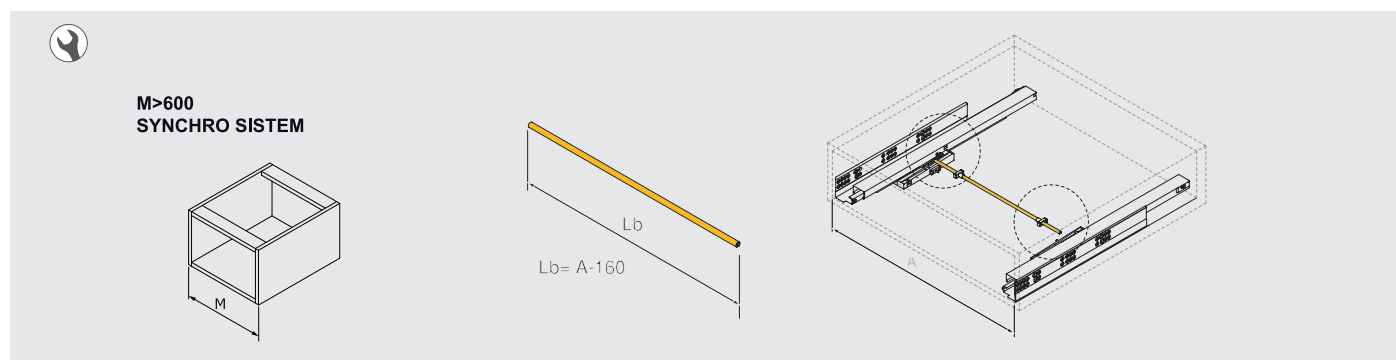

ACCESSORIES VERTEX // AKCESORIA VERTEX

Set of frontal fittings for 83 mm inner drawer

Zestaw zaczepów frontowych do szuflady wewnętrznej Vertex o wysokości 83 mm

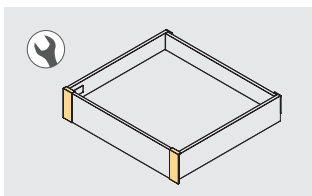

Height Wysokość	Finishing Wykończenie	Format Format	Cod.
83	White plastic Biały plastik	4 Pair/Kpl.	3172015
83	Anthracite grey plastic Szaro-antracytowy plastik	4 Pair/Kpl.	3172023

Plastic
Plastik

Set of frontal fittings for 93 mm inner drawer

Zestaw zaczepów frontowych do szuflady wewnętrznej Vertex o wysokości 93 mm

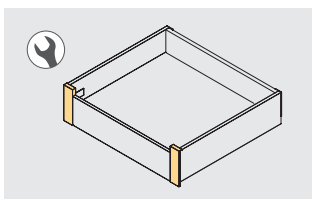

Height Wysokość	Finishing Wykończenie	Format Format	Cod.
93	White plastic Biały plastik	4 Pair/Kpl.	3172115
93	Anthracite grey plastic Szaro-antracytowy plastik	4 Pair/Kpl.	3172123

Plastic
Plastik

Set of frontal fittings for 131 mm inner drawer

Zestaw zaczepów frontowych do szuflady wewnętrznej Vertex o wysokości 131 mm

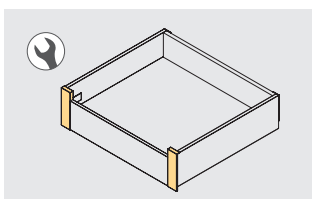
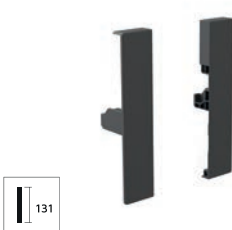

Height Wysokość	Finishing Wykończenie	Format Format	Cod.
131	White plastic Biały plastik	4 Pair/Kpl.	3172215
131	Anthracite grey plastic Szaro-antracytowy plastik	4 Pair/Kpl.	3172223

Plastic
Plastik

Set of frontal fittings for 178 mm inner drawer

Zestaw zaczepów frontowych do szuflady wewnętrznej Vertex o wysokości 178 mm

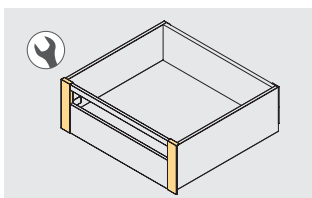

Height Wysokość	Finishing Wykończenie	Format Format	Cod.
178	White plastic Biały plastik	4 Pair/Kpl.	3172315
178	Anthracite grey plastic Szaro-antracytowy plastik	4 Pair/Kpl.	3172323

Plastic
Plastik



ACCESSORIES VERTEX // AKCESORIA VERTEX

Frontal profile for inner drawer

Profil frontowy do szuflady wewnętrznej Vertex

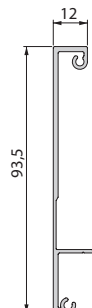

Longitude Długość	Finishing Wykończenie	Format Format	Cod.
1,10 m	White painted Malowane na biało	10 Ut/Szt	3172412
1,10 m	Anthracite grey Szary antracyt	10 Ut/Szt	3172435

Aluminium
Aluminium

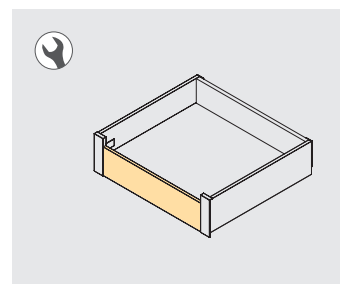

Frontal railing for inner drawer

Reling frontowy 185 mm



Height Wysokość	Longitude Długość	Finishing Wykończenie	Format Format	Cod.
178	1,12 m	White painted Malowane na biało	10 Ut/Szt	3113412
178	1,12 m	Anthracite grey Szary antracyt	10 Ut/Szt	3113435

Aluminium
Aluminium

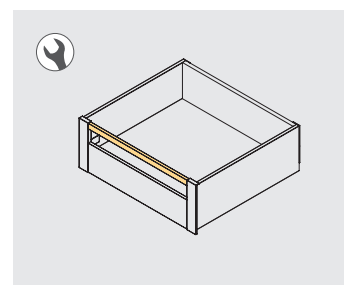

Lateral spacer for drawer

Przekładka boczna do szuflad

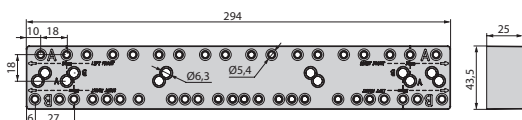

Finishing Wykończenie	Format Format	Cod.
White plastic Biały plastik	4 Ut/Szt	3110815
Grey plastic Szary plastik	4 Ut/Szt	3110821
Anthracite grey plastic Szaro-antracytowy plastik	4 Ut/Szt	3110823

Plastic
Plastik

INFORMATION INFORMACJE

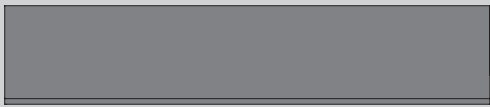
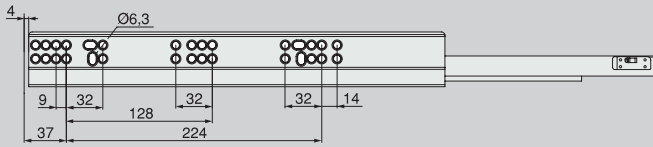

H
83
93
131
178

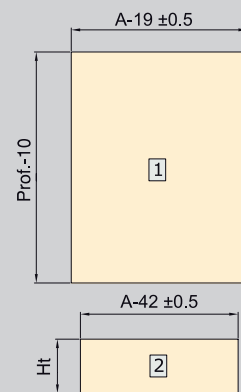
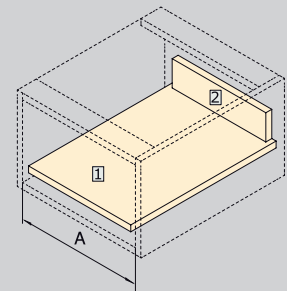
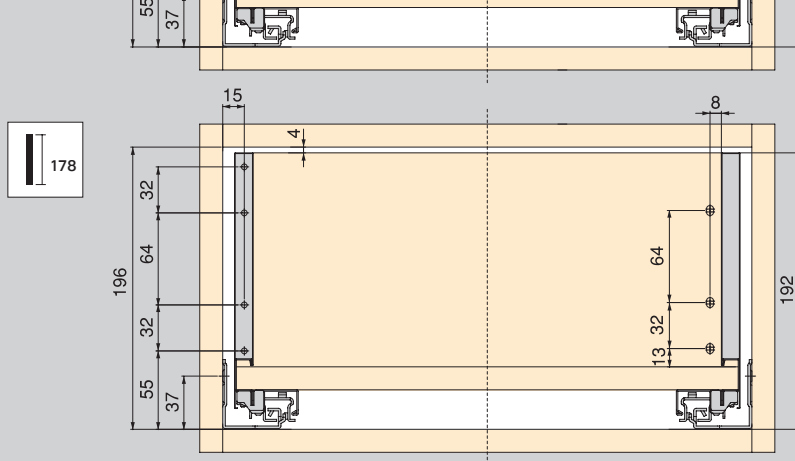
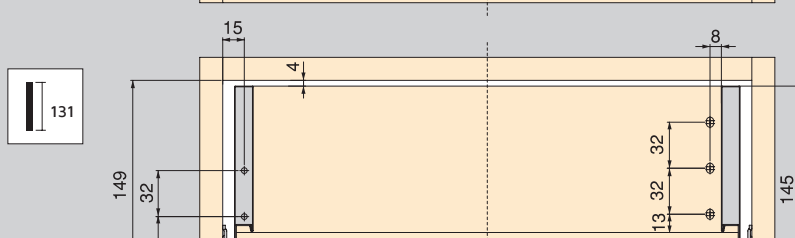
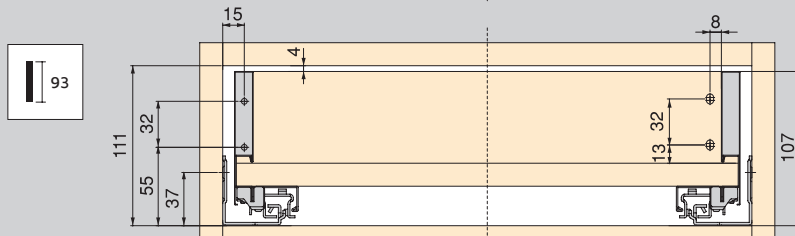
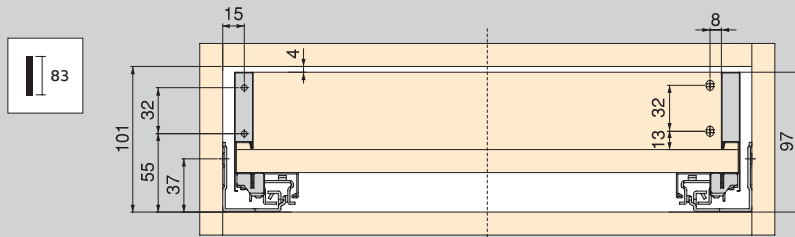
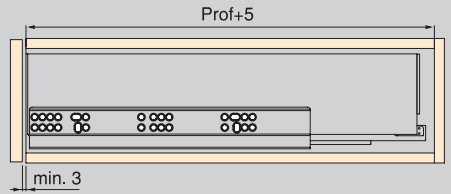
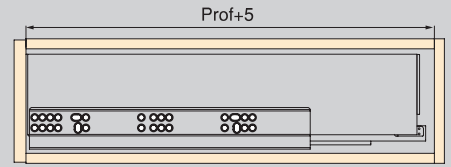

H	Ht
83	53
93	63
131	101
178	148

CONCEPT

CONCEPT



CONCEPT DRAWER INDUSTRIAL PACKAGING // SZUFLADA CONCEPT OPAKOWANIE ZBIORCZE

Concept metal sides height 105 mm LEFT

Bok do szuflady Concept o wysokości 105 mm LEWY

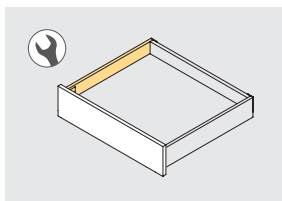

Depth Głębokość	Finishing Wykończenie	Format Format	Cod.
350	Anthracite grey Szary antracyt	20 Ut/Szt	3106735
450	Anthracite grey Szary antracyt	20 Ut/Szt	3106935
500	Anthracite grey Szary antracyt	20 Ut/Szt	3107035

Steel
Stal

Concept metal sides height 105 mm RIGHT

Bok do szuflady Concept o wysokości 105 mm PRAWY

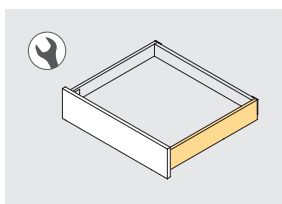

Depth Głębokość	Finishing Wykończenie	Format Format	Cod.
350	Anthracite grey Szary antracyt	20 Ut/Szt	3106035
450	Anthracite grey Szary antracyt	20 Ut/Szt	3106235
500	Anthracite grey Szary antracyt	20 Ut/Szt	3106335

Steel
Stal

Concept metal sides height 138 mm LEFT

Bok do szuflady Concept o wysokości 138 mm LEWY

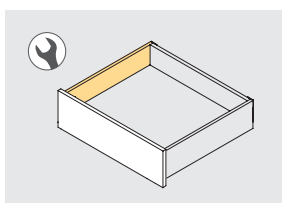

Depth Głębokość	Finishing Wykończenie	Format Format	Cod.
350	Anthracite grey Szary antracyt	20 Ut/Szt	3108135
450	Anthracite grey Szary antracyt	20 Ut/Szt	3108335
500	Anthracite grey Szary antracyt	20 Ut/Szt	3108435

Steel
Stal

Concept metal sides height 138 mm RIGHT

Bok do szuflady Concept o wysokości 138 mm PRAWY

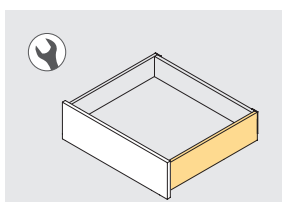

Depth Głębokość	Finishing Wykończenie	Format Format	Cod.
350	Anthracite grey Szary antracyt	20 Ut/Szt	3107435
450	Anthracite grey Szary antracyt	20 Ut/Szt	3107635
500	Anthracite grey Szary antracyt	20 Ut/Szt	3107735

Steel
Stal

Concept drawer // Szuflada Concept

CONCEPT DRAWER INDUSTRIAL PACKAGING // SZUFLADA CONCEPT OPAKOWANIE ZBIORCZE

Concept metal sides height 185 mm LEFT

Bok do szuflady Concept o wysokości 185 mm LEWY



Depth Głębokość	Finishing Wykończenie	Format Format	Cod.
450	Anthracite grey Szary antracyt	10 Ut/Szt	3109735
500	Anthracite grey Szary antracyt	10 Ut/Szt	3109835

Steel
Stal

Concept metal sides height 185 mm RIGHT

Bok do szuflady Concept o wysokości 185 mm PRAWY



Depth Głębokość	Finishing Wykończenie	Format Format	Cod.
450	Anthracite grey Szary antracyt	10 Ut/Szt	3109035
500	Anthracite grey Szary antracyt	10 Ut/Szt	3109135

Steel
Stal

Concept 30 kg runner slides with soft closing LEFT

Prowadnica Concept 30 kg z cichym domykaniem LEWY

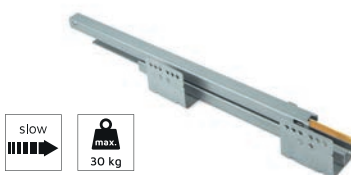

Depth Głębokość	Finishing Wykończenie	Format Format	Cod.
350	Zinc plated Cynkowane	20 Ut/Szt	3105305
450	Zinc plated Cynkowane	20 Ut/Szt	3105505
500	Zinc plated Cynkowane	20 Ut/Szt	3105605

Steel
Stal

Concept 30 kg runner slides with soft closing RIGHT

Prowadnice Concept 30 kg z delikatnym domykaniem PRAWY

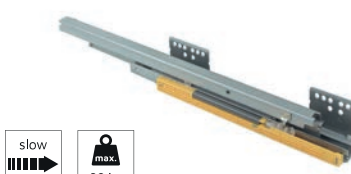

Depth Głębokość	Finishing Wykończenie	Format Format	Cod.
350	Zinc plated Cynkowane	20 Ut/Szt	3104605
450	Zinc plated Cynkowane	20 Ut/Szt	3104805
500	Zinc plated Cynkowane	20 Ut/Szt	3104905

Steel
Stal

CONCEPT DRAWER INDUSTRIAL PACKAGING // SZUFLADA CONCEPT OPAKOWANIE ZBIORCZE

Kit of front clip for drawer

Zestaw zacisków do szuflad

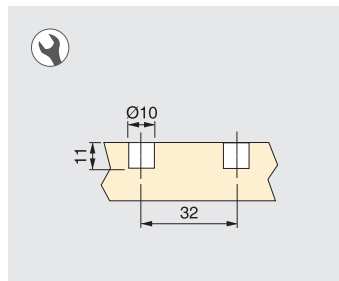

Description Opis	Finishing Wykończenie	Format Format	Cod.
Screw-on Przykręcane	Zinc plated Cynkowane	100 Pair/Kpl.	3104005
Knock-in Ø10 x 11 Wciskane Ø10 x 11	Zinc plated Cynkowane	100 Pair/Kpl.	3104105

Steel
Stal

Kit of front clip height 185 mm for Concept drawer

Zestaw zacisków 185 mm do szuflad Concept

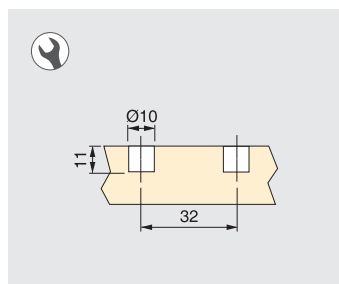

Description Opis	Finishing Wykończenie	Format Format	Cod.
Screw-on Przykręcane	Zinc plated Cynkowane	50 Pair/Kpl.	3104205
Knock-in Ø10 x 11 Wciskane Ø10 x 11	Zinc plated Cynkowane	50 Pair/Kpl.	3104305

Steel
Stal

Template to marked the clips of the Concept drawer front

Szablon do mocowania zacisku frontu szuflady



Finishing Wykończenie	Format Format	Cod.
Grey plastic Szary plastik	1 Pair/Kpl.	3114021

Plastic
Plastik

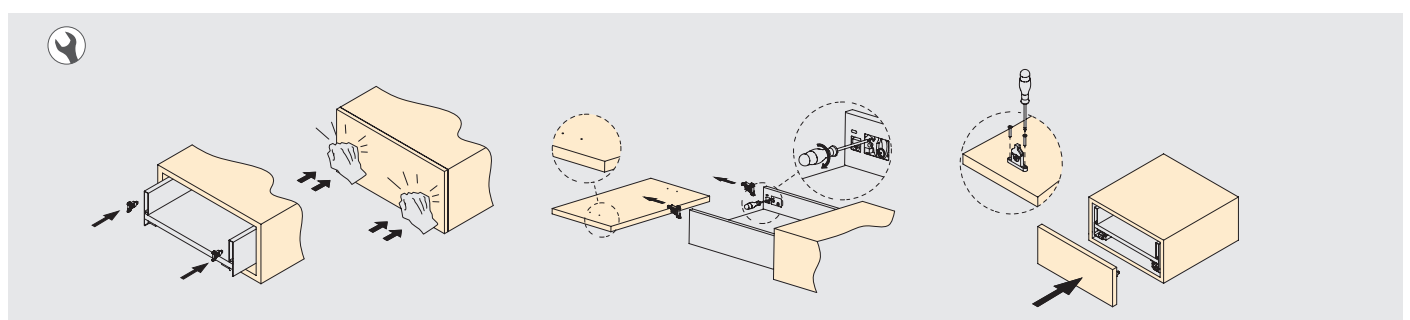

Concept 30 kg exterior drawer height 105 mm

Szuflada zewnętrzna Concept 30 kg wysokość 105 mm

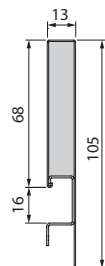
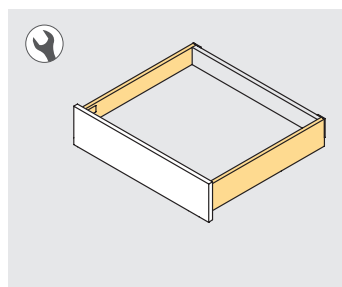

Depth Głębokość	Finishing Wykończenie	Format Format	Cod.
300	White painted Malowane na biało	1 KIT/Zestaw	3100112
350	White painted Malowane na biało	1 KIT/Zestaw	3100212
400	White painted Malowane na biało	1 KIT/Zestaw	3100312
450	White painted Malowane na biało	1 KIT/Zestaw	3100412
500	White painted Malowane na biało	1 KIT/Zestaw	3100512
270	Anthracite grey Szary antracyt	1 KIT/Zestaw	3100035
300	Anthracite grey Szary antracyt	1 KIT/Zestaw	3100135
350	Anthracite grey Szary antracyt	1 KIT/Zestaw	3100235
400	Anthracite grey Szary antracyt	1 KIT/Zestaw	3100335
450	Anthracite grey Szary antracyt	1 KIT/Zestaw	3100435
500	Anthracite grey Szary antracyt	1 KIT/Zestaw	3100535

Steel
Stal

Concept 30 kg exterior drawer height 138 mm

Szuflada zewnętrzna Concept 30 kg wysokość 138 mm

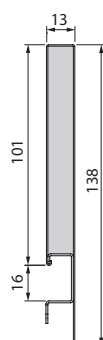
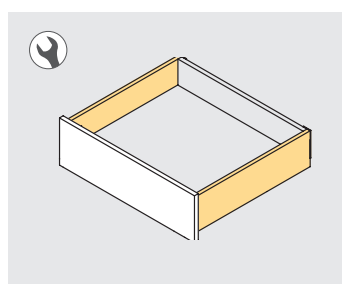
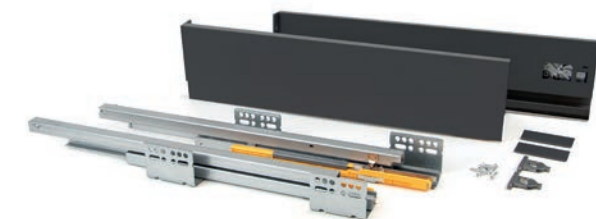

Depth Głębokość	Finishing Wykończenie	Format Format	Cod.
270	White painted Malowane na biało	1 KIT/Zestaw	3100612
300	White painted Malowane na biało	1 KIT/Zestaw	3100712
350	White painted Malowane na biało	1 KIT/Zestaw	3100812
400	White painted Malowane na biało	1 KIT/Zestaw	3100912
450	White painted Malowane na biało	1 KIT/Zestaw	3101012
500	White painted Malowane na biało	1 KIT/Zestaw	3101112
270	Anthracite grey Szary antracyt	1 KIT/Zestaw	3100635
300	Anthracite grey Szary antracyt	1 KIT/Zestaw	3100735
350	Anthracite grey Szary antracyt	1 KIT/Zestaw	3100835
400	Anthracite grey Szary antracyt	1 KIT/Zestaw	3100935
450	Anthracite grey Szary antracyt	1 KIT/Zestaw	3101035
500	Anthracite grey Szary antracyt	1 KIT/Zestaw	3101135

Steel
Stal

CONCEPT DRAWER KIT // ZESTAW SZUFLADA CONCEPT

Concept 30 kg exterior drawer height 185 mm

Szuflada zewnętrzna Concept 30 kg wysokość 185 mm

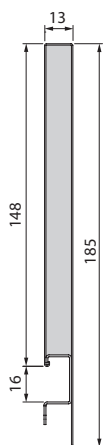
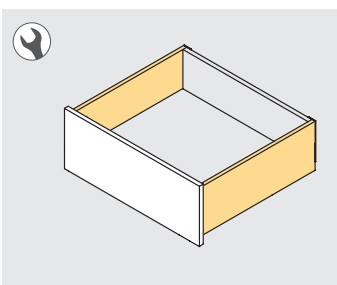

Depth Głębokość	Finishing Wykończenie	Format Format	Cod.
350	White painted Malowane na biało	1 KIT/Zestaw	3101412
400	White painted Malowane na biało	1 KIT/Zestaw	3101512
450	White painted Malowane na biało	1 KIT/Zestaw	3101612
500	White painted Malowane na biało	1 KIT/Zestaw	3101712
350	Anthracite grey Szary antracyt	1 KIT/Zestaw	3101435
400	Anthracite grey Szary antracyt	1 KIT/Zestaw	3101535
450	Anthracite grey Szary antracyt	1 KIT/Zestaw	3101635
500	Anthracite grey Szary antracyt	1 KIT/Zestaw	3101735

Steel
Stal



Set of gallery rails for Concept kitchen and bathroom drawers

Zestaw relingów do szuflad kuchennych i łazienkowych Concept



Depth Głębokość	Finishing Wykończenie	Format Format	Cod.
300	White painted Malowane na biało	20 Pair/Kpl.	3110112
350	White painted Malowane na biało	20 Pair/Kpl.	3110212
400	White painted Malowane na biało	20 Pair/Kpl.	3110312
450	White painted Malowane na biało	20 Pair/Kpl.	3110412
500	White painted Malowane na biało	20 Pair/Kpl.	3110512
550	White painted Malowane na biało	20 Pair/Kpl.	3110712
300	Anthracite grey Szary antracyt	20 Pair/Kpl.	3110135
350	Anthracite grey Szary antracyt	20 Pair/Kpl.	3110235
400	Anthracite grey Szary antracyt	20 Pair/Kpl.	3110335
450	Anthracite grey Szary antracyt	20 Pair/Kpl.	3110435
500	Anthracite grey Szary antracyt	20 Pair/Kpl.	3110535
550	Anthracite grey Szary antracyt	20 Pair/Kpl.	3110735

Steel
Stal

Set of dividers for interior of Vertex-Concept drawers

Adjustable drawer organiser kit



Width Szerokość	Finishing Wykończenie	Format Format	Cod.
600	White painted Malowane na biało	1 Ut/Szt	3184012
900	White painted Malowane na biało	1 Ut/Szt	3184112
600	Anthracite grey Szary antracyt	1 Ut/Szt	3184035
900	Anthracite grey Szary antracyt	1 Ut/Szt	3184135

Aluminium, Plastic
Aluminium, Plastik

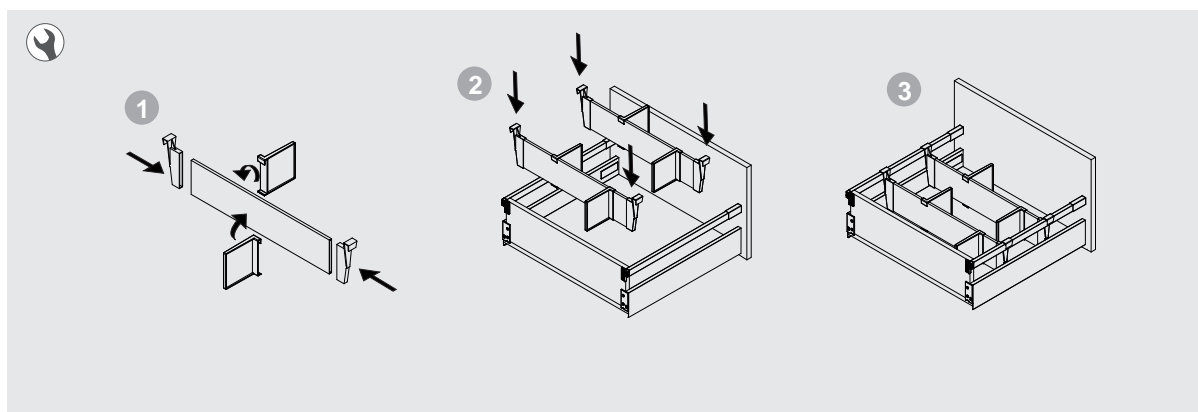





ACCESSORIES CONCEPT // AKCESORIA CONCEPT

Screw-on front fixing for railing for Concept drawer

Przykręcany frontowy element mocujący do relingu do szuflad Concept



Finishing Wykończenie	Format Format	Cod.
Grey plastic Szary plastik	200 Ut/Szt	3110021

Plastic
Plastik

Set of frontal fittings for 105 mm inner drawer

Zestaw frontowych elementów mocujących 105 mm

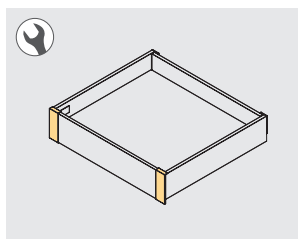

Height Wysokość	Finishing Wykończenie	Format Format	Cod.
105	White plastic Biały plastik	4 Pair/Kpl.	3113015
105	Anthracite grey plastic Szaro-antracytowy plastik	4 Pair/Kpl.	3113023

Plastic
Plastik

Set of frontal fittings for 138 mm inner drawer

Zestaw frontowych elementów mocujących 138 mm

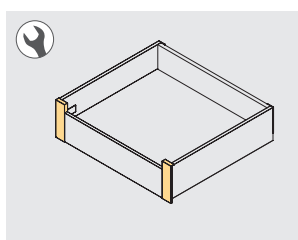

Height Wysokość	Finishing Wykończenie	Format Format	Cod.
138	White plastic Biały plastik	4 Pair/Kpl.	3113115
138	Anthracite grey plastic Szaro-antracytowy plastik	4 Pair/Kpl.	3113123

Plastic
Plastik

Set of frontal fittings for 185 mm inner drawer

Zestaw frontowych elementów mocujących 185 mm

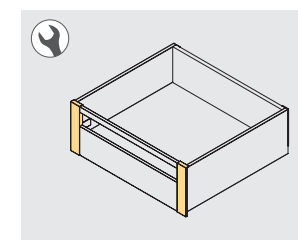

Height Wysokość	Finishing Wykończenie	Format Format	Cod.
185	White plastic Biały plastik	4 Pair/Kpl.	3113215
185	Anthracite grey plastic Szaro-antracytowy plastik	4 Pair/Kpl.	3113223

Plastic
Plastik

ACCESSORIES CONCEPT // AKCESORIA CONCEPT

Frontal profile for inner drawer

Profil frontowy

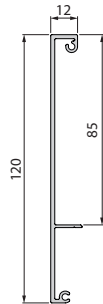
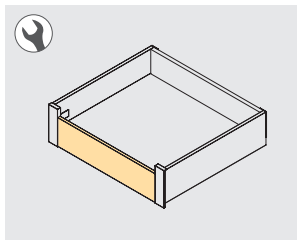

Longitude Długość	Finishing Wykończenie	Format Format	Cod.
1,07 m	White painted Malowane na biało		10 Ut/Szt 3113312
1,07 m	Anthracite grey Szary antracyt		10 Ut/Szt 3113335

Aluminium
Aluminium

Frontal railing for inner drawer

Reling frontowy 185 mm

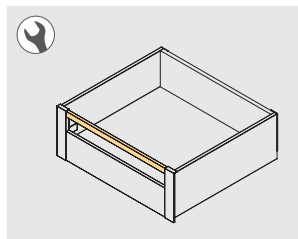

Height Wysokość	Longitude Długość	Finishing Wykończenie	Format Format	Cod.
178	1,12 m	White painted Malowane na biało		10 Ut/Szt 3113412
178	1,12 m	Anthracite grey Szary antracyt		10 Ut/Szt 3113435

Aluminium
Aluminium

Lateral spacer for drawer

Przekładka boczna do szuflad



Finishing Wykończenie	Format Format	Cod.
White plastic Biały plastik		4 Ut/Szt 3110815
Grey plastic Szary plastik		4 Ut/Szt 3110821
Anthracite grey plastic Szaro-antracytowy plastik		4 Ut/Szt 3110823

Plastic
Plastik

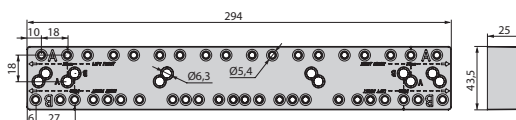

ACCESSORIES CONCEPT // AKCESORIA CONCEPT

Lokbox joint for fastening the drawer bottom to the front

Łącznik frontu Lokbox do mocowania dna szuflady do krawędzi



Finishing Wykończenie	Format Format	Cod.
Grey plastic Szary plastik	100 Ut/Szt	3002621

Plastic
Plastik

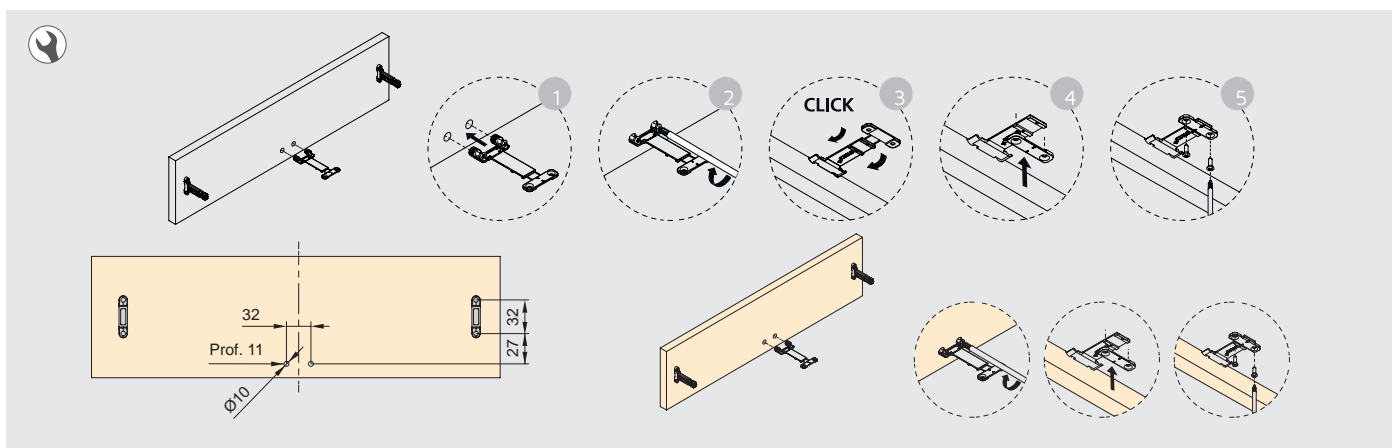



INFORMATION INFORMACJE

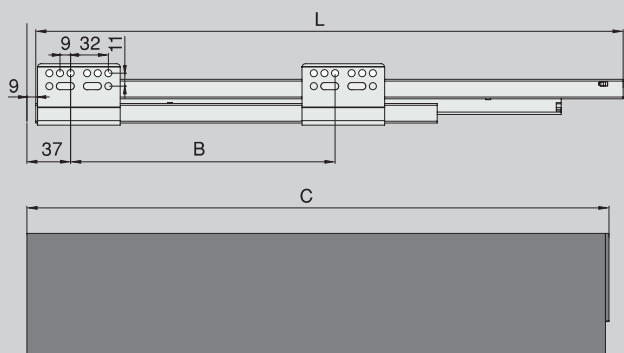

H	Prof.	L	B	C
105 138 185	270	268	96	263
	300	298	128	293
	350	348	128	343
	400	398	192	393
	450	448	224	443
500	498	224	493	

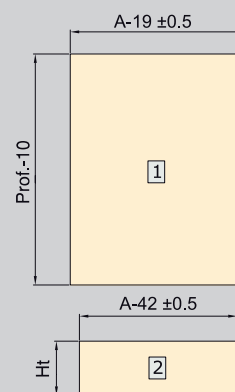
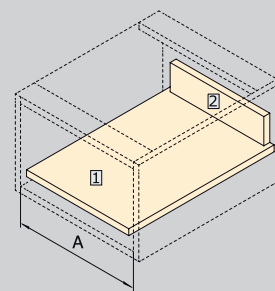
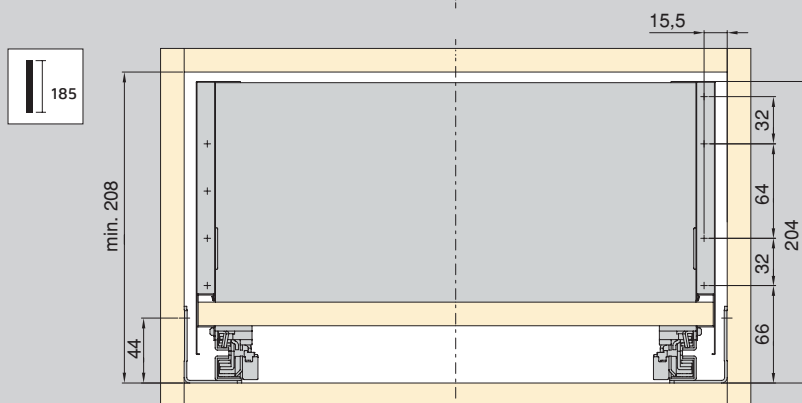
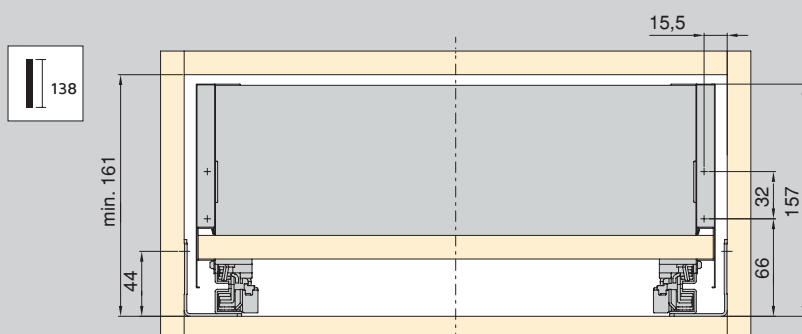
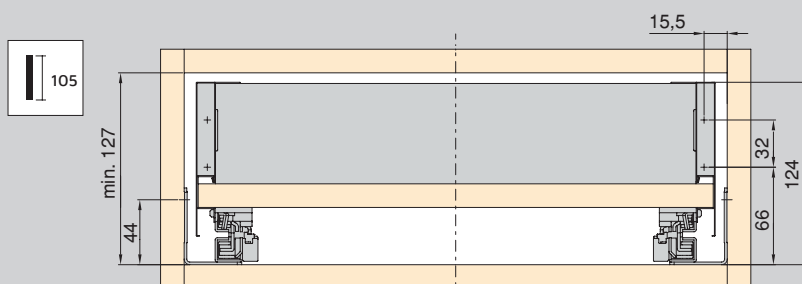
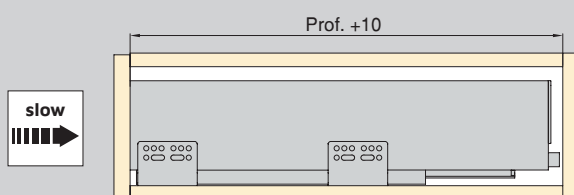

Prof.	Ht
105	68
138	102
185	149

VANTAGE-Q

VANTAGE-Q

emuca 

emuca 

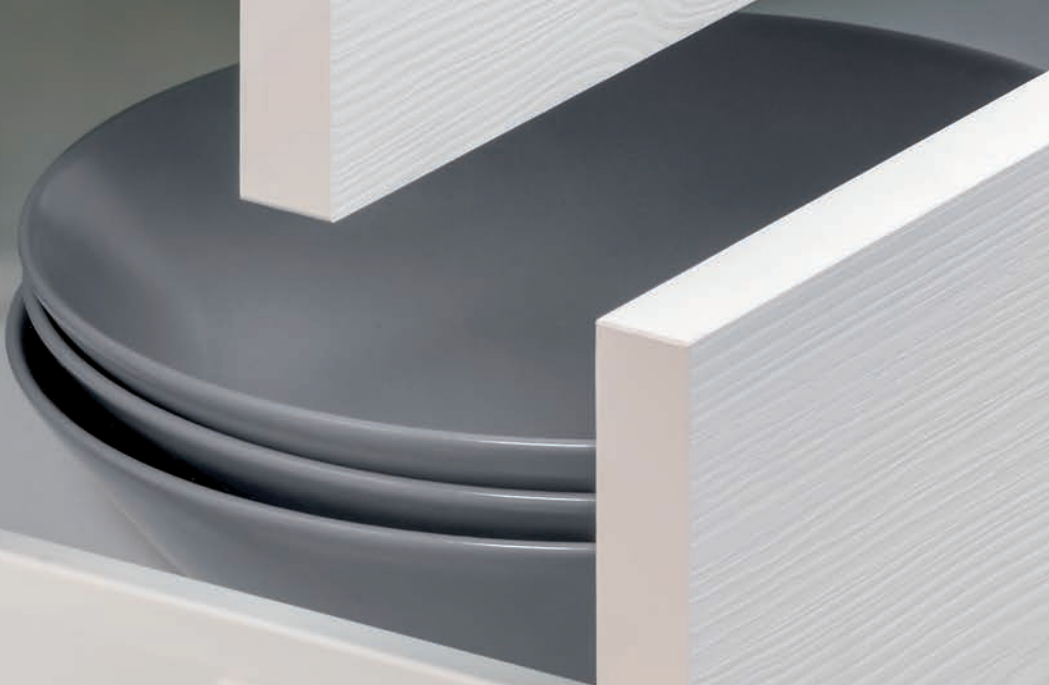

COMPOSITIONS VANTAGE-Q // ELEMENTY VANTAGE-Q

Vantage-Q runner slides with soft closing

Prowadnice szuflad Vantage-Q z miękkim domykaniem



Depth Głębokość	Finishing Wykończenie	Format Format	Cod.
270	Zinc plated Cynkowane	4 Pair/Kpl.	4188705
300	Zinc plated Cynkowane	4 Pair/Kpl.	4188805
350	Zinc plated Cynkowane	4 Pair/Kpl.	4188905
400	Zinc plated Cynkowane	4 Pair/Kpl.	4189005
450	Zinc plated Cynkowane	4 Pair/Kpl.	4189105
500	Zinc plated Cynkowane	4 Pair/Kpl.	4189205
500	Zinc plated Cynkowane	4 Pair/Kpl.	3012705

Steel
Stal

Vantage-Q metal sides height 83mm

Zestaw boków Vantage-Q

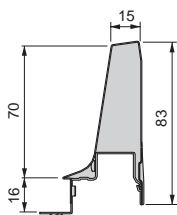

Depth Głębokość	Finishing Wykończenie	Format Format	Cod.
270	White painted Malowane na biało	4 Pair/Kpl.	3012812
300	White painted Malowane na biało	4 Pair/Kpl.	3012912
350	White painted Malowane na biało	4 Pair/Kpl.	3013012
400	White painted Malowane na biało	4 Pair/Kpl.	3013112
450	White painted Malowane na biało	4 Pair/Kpl.	3013212
500	White painted Malowane na biało	4 Pair/Kpl.	3013312
270	Silver painted Malowane aluminium	4 Pair/Kpl.	3012825
300	Silver painted Malowane aluminium	4 Pair/Kpl.	3012925
350	Silver painted Malowane aluminium	4 Pair/Kpl.	3013025
400	Silver painted Malowane aluminium	4 Pair/Kpl.	3013125
450	Silver painted Malowane aluminium	4 Pair/Kpl.	3013225
500	Silver painted Malowane aluminium	4 Pair/Kpl.	3013325

Steel
Stal

COMPOSITIONS VANTAGE-Q // ELEMENTY VANTAGE-Q

Set of fittings for metal sides height 83 mm

Zestaw haczyków żeberkowych do szuflad Vantage-Q, wysokość 83 mm



Height Wysokość	Description Opis	Finishing Wykończenie	Format Format	Cod.
83	For drawer Dla szuflady	White painted Malowane na biało	20 Pair/Kpl.	3003812
141	For drawer with 1 railing Do szuflady z 1 relingiem	White painted Malowane na biało	20 Pair/Kpl.	3006612
204	For drawer with 2 railings Do szuflady z 2 relingami	White painted Malowane na biało	20 Pair/Kpl.	3000312
83	For drawer Dla szuflady	Silver painted Malowane aluminium	20 Pair/Kpl.	3003825
141	For drawer with 1 railing Do szuflady z 1 relingiem	Silver painted Malowane aluminium	20 Pair/Kpl.	3006625
204	For drawer with 2 railings Do szuflady z 2 relingami	Silver painted Malowane aluminium	20 Pair/Kpl.	3000325

Steel Stal

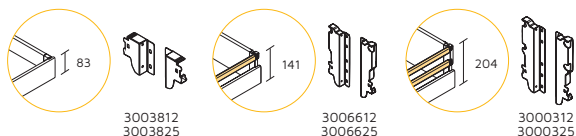

Kit of front clip for external drawer Vantage-Q

Zestaw haczyków do szuflady zewnętrznej Vantage-Q



Description Opis	Finishing Wykończenie	Format Format	Cod.
Screw-on Przykręcane	Zinc plated Cynkowane	20 Pair/Kpl.	4189905
Knock-in Ø10 x 11 Wciskane Ø10 x 11	Zinc plated Cynkowane	20 Pair/Kpl.	4190005

Steel, Zamak Stal, Znak

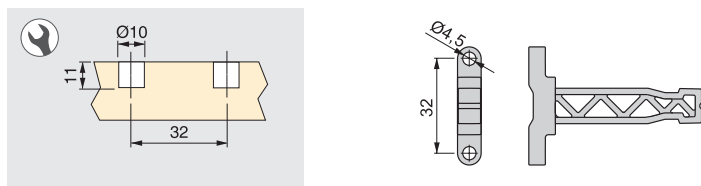

Stabilizer set for Vantage-Q drawer

Zestaw stabilizatora do szuflad Vantage-Q



Depth Głębokość	Finishing Wykończenie	Format Format	Cod.
500	Grey plastic Szary plastik	8 Pair/Kpl.	4199021

Steel, aluminium and plastic Stal, aluminium i plastik

DRAWER VANTAGE-Q KIT // ZESTAW SZUFLADA VANTAGE-Q

Vantage-Q drawer kit for kitchens and bathrooms, soft close

Zestaw szuflad kuchennych i łazienkowych Vantage-Q, cichy domyk

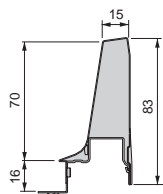

Depth Głębokość	Finishing Wykończenie	Format Format	Cod.
350	White painted Malowane na biało	1 KIT/Zestaw	3015312
450	White painted Malowane na biało	1 KIT/Zestaw	3015512
500	White painted Malowane na biało	1 KIT/Zestaw	3015612
550	White painted Malowane na biało	1 KIT/Zestaw	3016312
270	Silver painted Malowane aluminium	1 KIT/Zestaw	3015125
300	Silver painted Malowane aluminium	1 KIT/Zestaw	3015225
350	Silver painted Malowane aluminium	1 KIT/Zestaw	3015325
400	Silver painted Malowane aluminium	1 KIT/Zestaw	3015425
450	Silver painted Malowane aluminium	1 KIT/Zestaw	3015525
500	Silver painted Malowane aluminium	1 KIT/Zestaw	3015625
550	Silver painted Malowane aluminium	1 KIT/Zestaw	3016325

Steel
Stal



COMPOSITIONS SQUARE RAILING // UKŁADY Z KWADRATOWYCH RELINGÓW

Kit of lateral railing for drawer

Zestaw relingu bocznego szuflady do szuflad

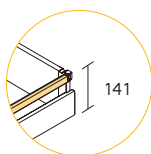
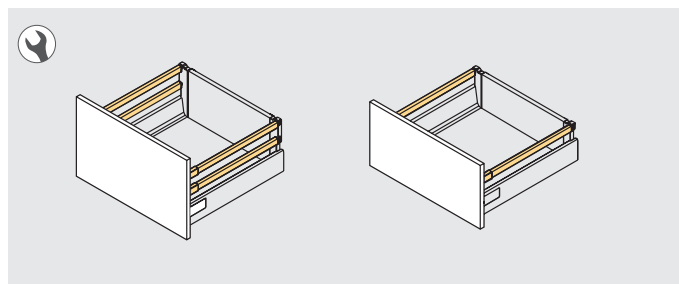

3006612
3006625

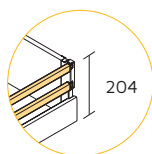

3000312
3000325

Depth Głębokość	Finishing Wykończenie	Format Format	Cod.
350	White painted Malowane na biało	20 Pair/Kpl.	3013612
400	White painted Malowane na biało	20 Pair/Kpl.	3013712
450	White painted Malowane na biało	20 Pair/Kpl.	3013812
500	White painted Malowane na biało	20 Pair/Kpl.	3006712
550	White painted Malowane na biało	20 Pair/Kpl.	3016412
270	Silver painted Malowane aluminium	20 Pair/Kpl.	3013425
300	Silver painted Malowane aluminium	20 Pair/Kpl.	3013525
350	Silver painted Malowane aluminium	20 Pair/Kpl.	3013625
400	Silver painted Malowane aluminium	20 Pair/Kpl.	3013725
450	Silver painted Malowane aluminium	20 Pair/Kpl.	3013825
500	Silver painted Malowane aluminium	20 Pair/Kpl.	3006725
550	Silver painted Malowane aluminium	20 Pair/Kpl.	3016425

Plastic, Steel
Plastik, Stal

Screw-on front fixing for railing

Przykręcany frontowy element mocujący do relingu

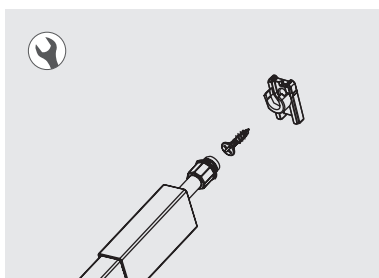

Finishing Wykończenie	Format Format	Cod.
Grey plastic Szary plastik	200 Ut/Szt	3015021

Plastic
Plastik

Back fitting for railing

Tylne nastawne elementy montażowe

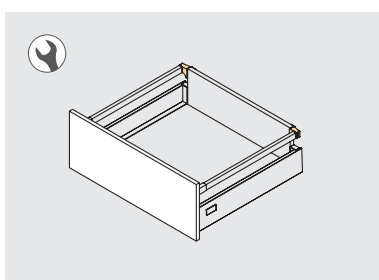

Finishing Wykończenie	Format Format	Cod.
Grey plastic Szary plastik	20 Pair/Kpl.	3028621

Plastic
Plastik

COMPOSITIONS SQUARE RAILING // UKŁADY Z KWADRATOWYCH RELINGÓW

Set of frontal fittings for 83 mm inner drawer

Zestaw zaczepów frontowych do szuflady wewnętrznej o wysokości 83mm

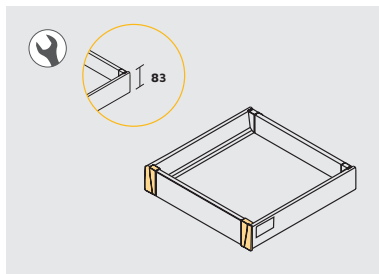

Finishing Wykończenie	Format Format	Cod.
Grey plastic Szary plastik	4 Pair/Kpl.	4190121

Plastic
Plastik

Set of frontal fittings for 141 mm inner drawer

Zestaw frontowych elementów mocujących 141 mm

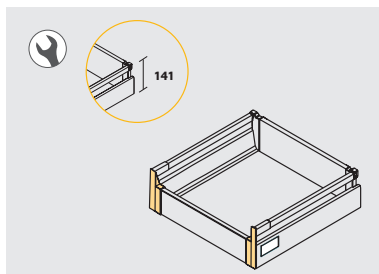

Finishing Wykończenie	Format Format	Cod.
Grey plastic Szary plastik	4 Pair/Kpl.	3014721

Plastic
Plastik

Set of frontal fittings for 204 mm inner drawer

Zestaw frontowych elementów mocujących 204 mm

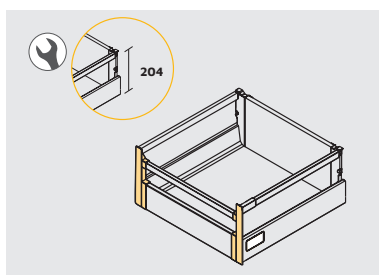
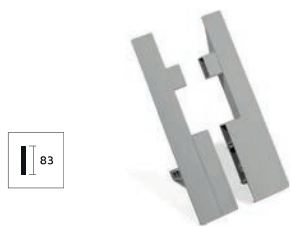

Finishing Wykończenie	Format Format	Cod.
Grey plastic Szary plastik	4 Pair/Kpl.	3014821

Plastic
Plastik

COMPOSITIONS SQUARE RAILING // UKŁADY Z KWADRATOWYCH RELINGÓW

Frontal railing for inner drawer

Reling frontowy do szuflady wewnętrznej

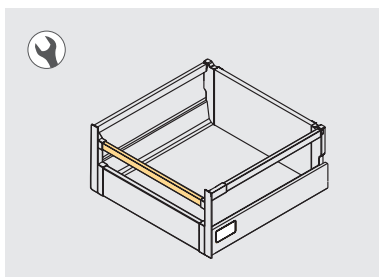

Longitude Długość	Finishing Wykończenie	Format Format	Cod.
1,13 m	Silver painted Malowane aluminium	10 Ut/Szt	3014925
			Steel Stal

Frontal profile for inner drawer

Profil frontowy do szuflady wewnętrznej

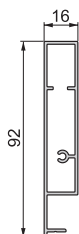

Longitude Długość	Finishing Wykończenie	Format Format	Cod.
1,1 m	Silver painted Malowane aluminium	10 Ut/Szt	4190425
			Aluminium Aluminium

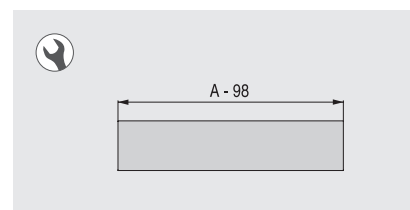

COMPOSITIONS ROUND RAILING // UKŁADY Z OKRĄGLYCH RELINGÓW

Kit of lateral round railing Ø11 for drawer

Zestaw relingu bocznej szuflady do szuflad



Depth Głębokość	Finishing Wykończenie	Format Format	Cod.
270	Silver painted Malowane aluminium	20 Pair/Kpl.	3015725
300	Silver painted Malowane aluminium	20 Pair/Kpl.	3015825
350	Silver painted Malowane aluminium	20 Pair/Kpl.	3015925
400	Silver painted Malowane aluminium	20 Pair/Kpl.	3016025
450	Silver painted Malowane aluminium	20 Pair/Kpl.	3016125
500	Silver painted Malowane aluminium	20 Pair/Kpl.	3016225

Aluminium, Plastic
Aluminium, Plastik

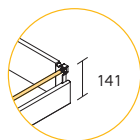
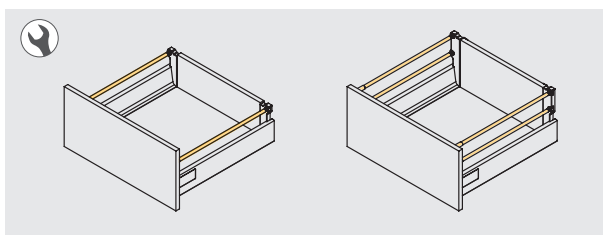

3006612
3006625

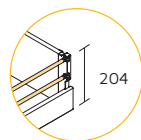

3000312
3000325

Back fitting for railing

Tylne nastawne elementy montażowe

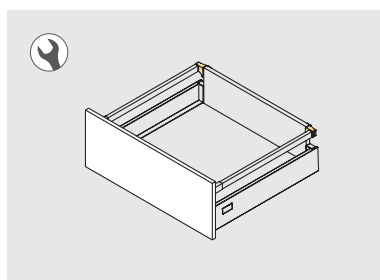

Finishing Wykończenie	Format Format	Cod.
Grey plastic Szary plastik	20 Pair/Kpl.	3028621

Plastic
Plastik

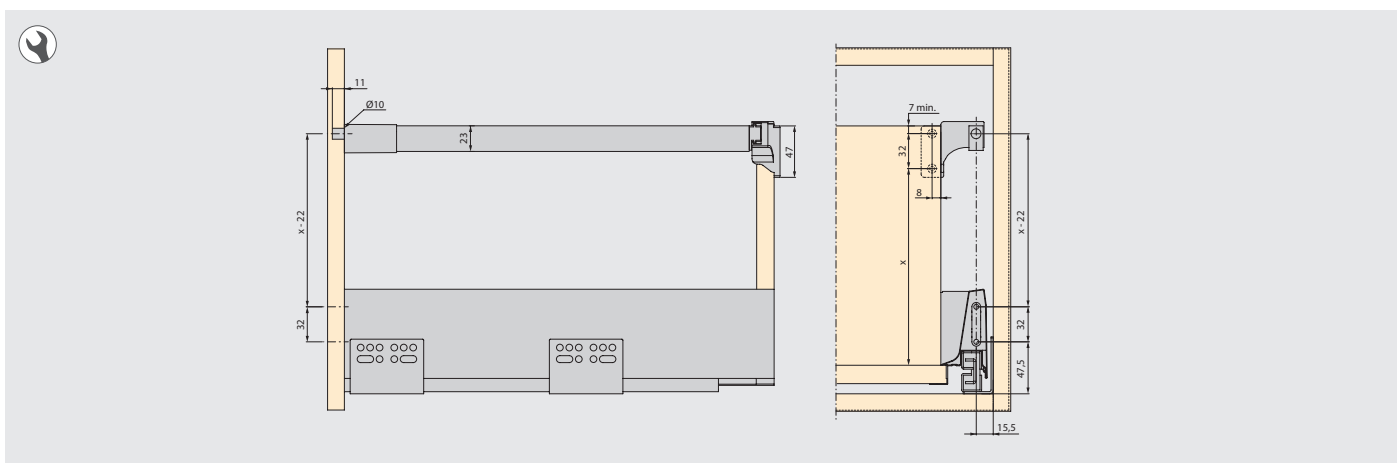

COMPOSITIONS ROUND RAILING // UKŁADY Z OKRĄGLYCH RELINGÓW

Set of frontal fittings for 141 mm inner drawer

Zestaw frontowych elementów mocujących 141 mm

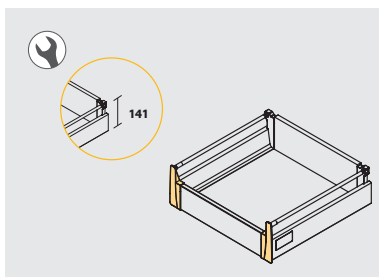

Finishing Wykończenie	Format Format	Cod.
Grey plastic Szary plastik	4 Pair/Kpl.	4190221

Plastic
Plastik

Set of frontal fittings for 204 mm inner drawer

Zestaw frontowych elementów mocujących 204 mm

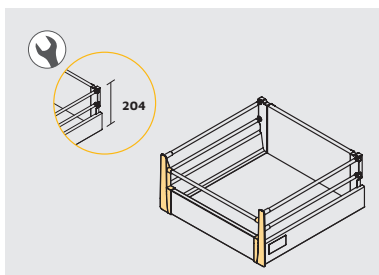

Finishing Wykończenie	Format Format	Cod.
Grey plastic Szary plastik	4 Pair/Kpl.	4190321

Plastic
Plastik

Frontal round railing Ø11 for inner drawer

Przedni reling Ø11 mm do szuflady wewnętrznej

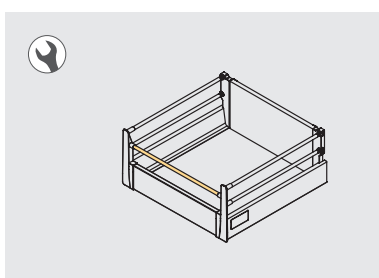

Longitude Długość	Finishing Wykończenie	Format Format	Cod.
1,13 m	Silver painted Malowane aluminium	10 Ut/Szt	4190525

Aluminium
Aluminium

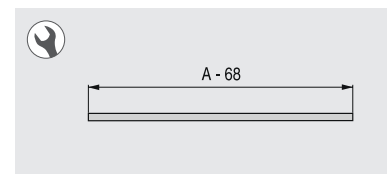

Front fixing for screw-mounted bar for drawer

Przykręcany frontowy element mocujący do relingu do szuflad

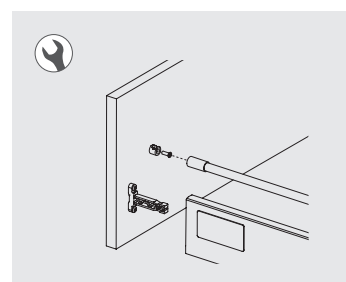

Finishing Wykończenie	Format Format	Cod.
Grey plastic Szary plastik	200 Ut/Szt	4005421

Plastic
Plastik

COMPOSITIONS ROUND RAILING // UKŁADY Z OKRĄGLYCH RELINGÓW

Frontal profile for inner drawer

Profil frontowy do szuflady wewnętrznej

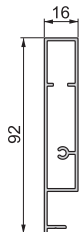
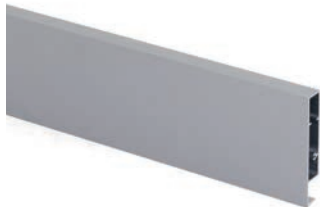

Longitude Długość	Finishing Wykończenie	Format Format	Cod.
1,1 m	Silver painted Malowane aluminium	10 Ut/Szt	4190425

Aluminium
Aluminium

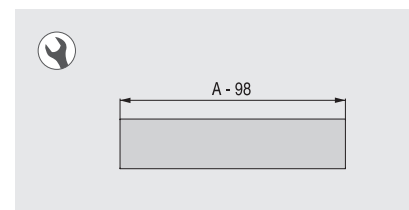

Mounting templates for Vantage-Q front drawer

Płytki montażowe do frontu szuflad kuchennych Vantage Q



Finishing Wykończenie	Format Format	Cod.
Grey plastic Szary plastik	1 Pair/Kpl.	4191821

Plastic, Steel
Plastik, Stal

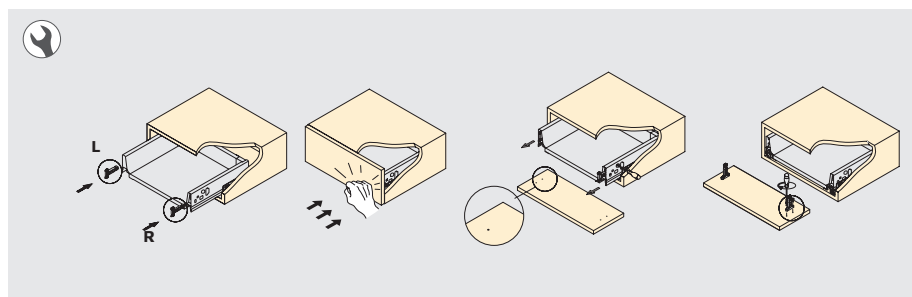

Mounting templates for Vantage-Q

Płytki montażowe szyna szuflady Vantage-Q



Finishing Wykończenie	Format Format	Cod.
Grey plastic Szary plastik	1 Ut/Szt	4191921

Plastic
Plastik

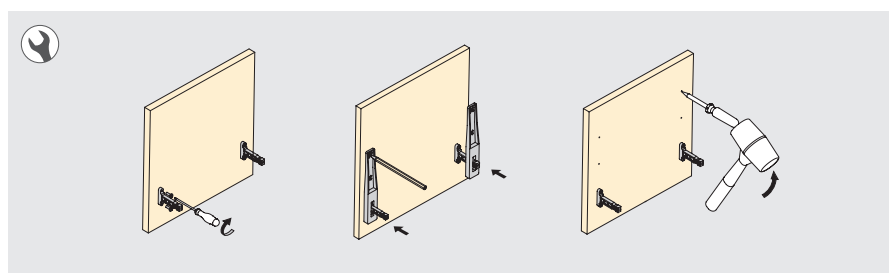



INFORMATION INFORMACJE

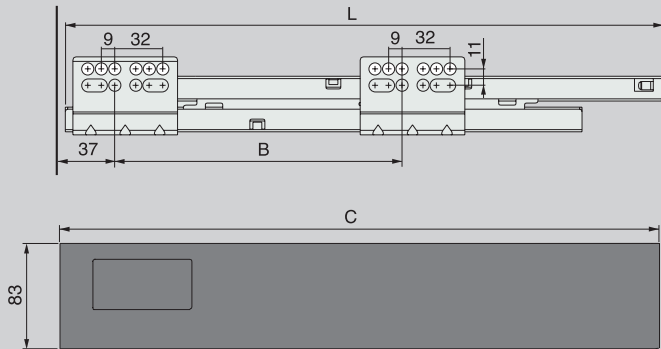

H	Prof.	L	B	C
83 141 204	270	268	96	267
	300	295	128	297
	350	345	128	347
	400	395	192	397
	450	445	224	447
500	495	224	497	

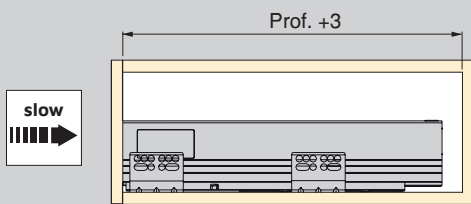

*** min.53 Exterior drawer / Szuflada zewn trzna
min.93 Interior drawer / Szuflada wewn trzna

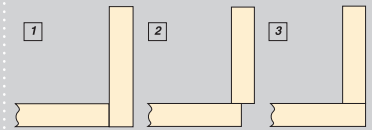
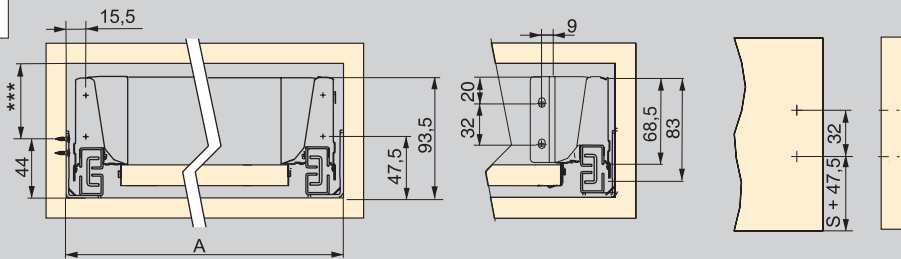

	1	2 - 3
83	84	68
141	135	119
204	199	183

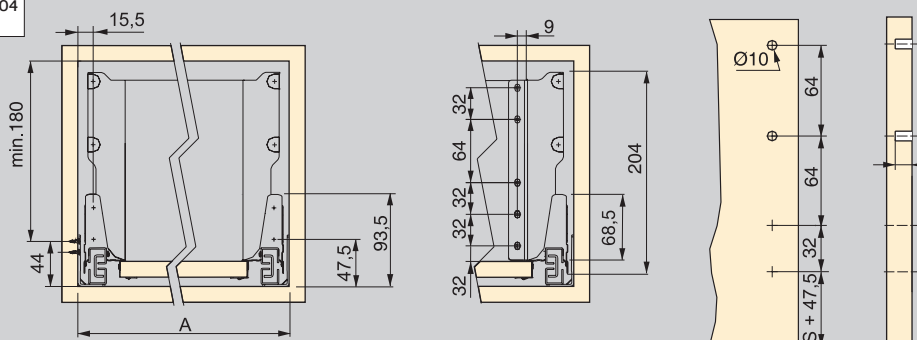
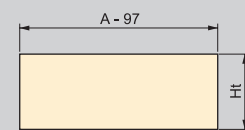
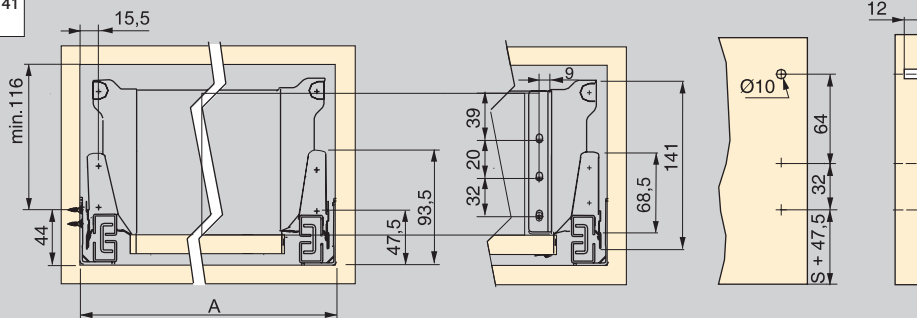

1	2(*)	3
Prof - 24	Prof - 20	Prof - 4

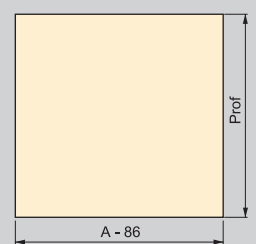

ULTRABOX

ULTRABOX



CAJÓN ULTRABOX // GAVETA ULTRABOX

Kitchen and bathroom Ultrabox drawer kit

Zestaw szuflad kuchennych i łazienki Ultrabox

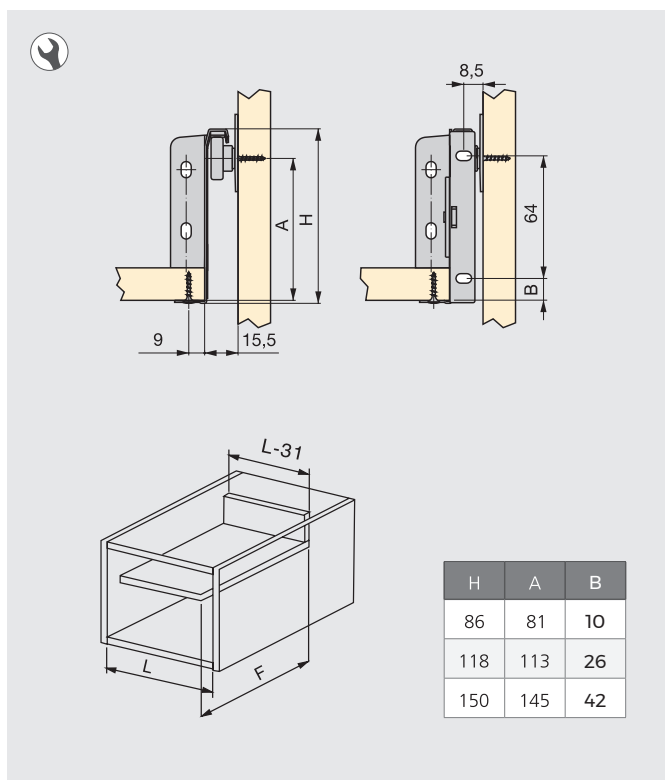
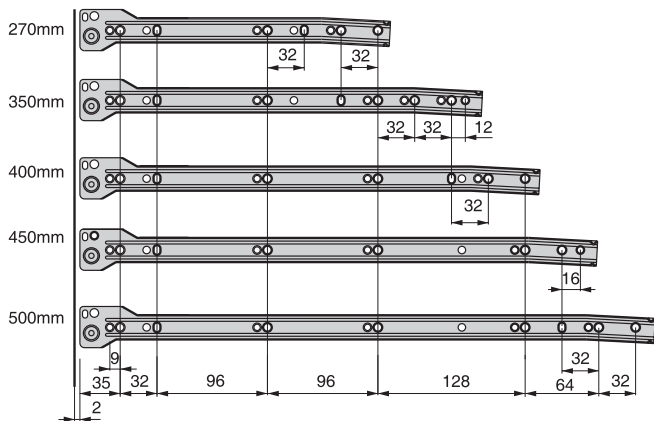

Height Wysokość	Depth Głębokość	Finishing Wykończenie	Format Format	Cod.
86	270	White painted Malowane na biało	10 Pair/Kpl.	4387312
86	400	White painted Malowane na biało	10 Pair/Kpl.	4387512
86	450	White painted Malowane na biało	10 Pair/Kpl.	4387612
86	500	White painted Malowane na biało	10 Pair/Kpl.	4387712
118	350	White painted Malowane na biało	10 Pair/Kpl.	4393812
118	400	White painted Malowane na biało	10 Pair/Kpl.	4387812
118	450	White painted Malowane na biało	10 Pair/Kpl.	4387912
118	500	White painted Malowane na biało	10 Pair/Kpl.	4388012
150	350	White painted Malowane na biało	10 Pair/Kpl.	4394012
150	400	White painted Malowane na biało	10 Pair/Kpl.	4388112
150	450	White painted Malowane na biało	10 Pair/Kpl.	4388212
150	500	White painted Malowane na biało	10 Pair/Kpl.	4388312
86	270	Silver painted Malowane aluminium	10 Pair/Kpl.	4387325
86	350	Silver painted Malowane aluminium	10 Pair/Kpl.	4387425
86	400	Silver painted Malowane aluminium	10 Pair/Kpl.	4387525
86	450	Silver painted Malowane aluminium	10 Pair/Kpl.	4387625
86	500	Silver painted Malowane aluminium	10 Pair/Kpl.	4387725
118	270	Silver painted Malowane aluminium	10 Pair/Kpl.	4393725
118	350	Silver painted Malowane aluminium	10 Pair/Kpl.	4393825
118	400	Silver painted Malowane aluminium	10 Pair/Kpl.	4387825
118	450	Silver painted Malowane aluminium	10 Pair/Kpl.	4387925
118	500	Silver painted Malowane aluminium	10 Pair/Kpl.	4388025
150	270	Silver painted Malowane aluminium	10 Pair/Kpl.	4393925
150	350	Silver painted Malowane aluminium	10 Pair/Kpl.	4394025
150	400	Silver painted Malowane aluminium	10 Pair/Kpl.	4388125
150	450	Silver painted Malowane aluminium	10 Pair/Kpl.	4388225
150	500	Silver painted Malowane aluminium	10 Pair/Kpl.	4388325

Steel
Stal

CAJÓN ULTRABOX // GAVETA ULTRABOX

Set of gallery rails for Ultrabox kitchen and bathroom drawers

Zestaw relingów do szuflady kuchennej i łazienkowej Ultrabox



Depth Głębokość	Finishing Wykończenie	Format Format	Cod.
500	White painted Malowane na biało	10 Pair/Kpl.	4393412
450	Silver painted Malowane aluminium	10 Pair/Kpl.	4393525
500	Silver painted Malowane aluminium	10 Pair/Kpl.	4393425

Plastic, Steel
Plastik, Stal

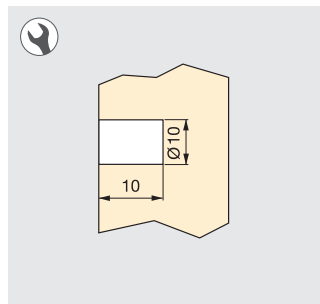
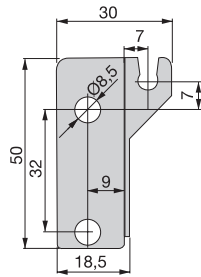

Cover for Ultrabox drawer

Ostona do szuflad Ultrabox



Finishing Wykończenie	Format Format	Cod.
Grey plastic Szary plastik	200 Ut/Szt	4961721

Plastic
Plastik

Activator for Ultrabox Soft Close slide

Aktywator dla mechanizmu delikatnego zamykania dla Ultrabox



Finishing Wykończenie	Format Format	Cod.
White plastic Biały plastik	200 Ut/Szt	4005715

Plastic
Plastik

CAJÓN ULTRABOX // GAVETA ULTRABOX

Soft close for T30 slides and Ultrabox drawer

Miękkie zamknięcie do prowadnic T30 i szuflady Ultrabox



Longitude Długość	Finishing Wykończenie	Format Format	Cod.
250-300 mm	Grey plastic Szary plastik	100 Ut/Szt	4005521
350-500 mm	Grey plastic Szary plastik	100 Ut/Szt	4005621

Plastic
Plastik



H	A	B
86	64	86
118	96	118
150	128	150

L = 270 ▶ 300

L = 350 ▶ 500

ACCESSORIES

AKCESORIA



UNDER-SINK INSERT // OSŁONA SYFONU

Steel under-sink insert

Metalowy tył szuflady pod zlewozmywakiem ze stali

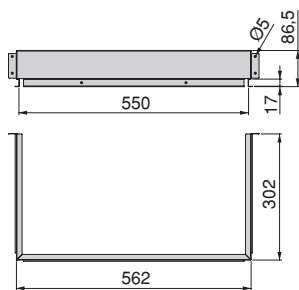

Finishing Wykończenie	Format Format	Cod.
White painted Malowane na biało	10 Ut/Szt	3017912
Silver painted Malowane aluminium	10 Ut/Szt	3017925
Anthracite grey Szary antracyt	10 Ut/Szt	3017935

Aluminium, Steel
Aluminium, Stal

MODEL	V	W	X	Y	Z
VERTEX	17,5	296	19	10	63
CONCEPT	17,5	296	19	10	68
VANTAGE-Q	12	279	86	24	84

Rectangular under sink insert for bathroom drawer

Uchwyt prostokątny do szuflady łazienkowej

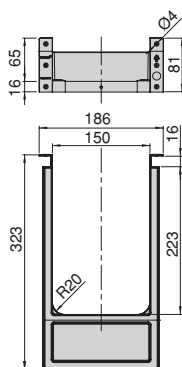

Finishing Wykończenie	Format Format	Cod.
White plastic Biały plastik	6 Ut/Szt	3044115
Grey plastic Szary plastik	6 Ut/Szt	3044121
Anthracite grey plastic Szaro-antracytowy plastik	6 Ut/Szt	3044123

Plastic
Plastik

MODEL	C	V	W	X	Y	Z
VERTEX	(A - 169) / 2	(A - 192) / 2	220	A - 19	Prof. - 10	63
			204		Prof. - 26	81
CONCEPT	(A - 169) / 2	(A - 192) / 2	220	A - 19	Prof. - 10	68
			204		Prof. - 26	84
VANTAGE-Q	(A - 236) / 2	(A - 247) / 2	204	A - 86	Prof. - 24	84
ULTRABOX	(A - 31) / 2	(A - 181) / 2	220	A - 31	Prof. - 1	68
			204		Prof. - 17	84

UNDER-SINK INSERT // OSŁONA SYFONU

Rectangular under-sink insert for drawer

Zapiesz prostokątny syfon do szuflad

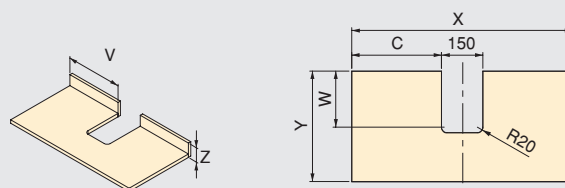
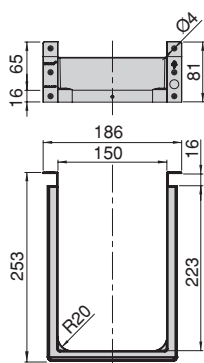

MODEL	C	V	W	X	Y	Z	
VERTEX	(A - 169) / 2	(A - 192) / 2	220	A - 19	Prof. - 10	63	
			204		Prof. - 26	81	
CONCEPT	(A - 169) / 2	(A - 192) / 2	220	A - 19	Prof. - 10	68	
			204		Prof. - 26	84	
VANTAGE-Q	(A - 236) / 2	(A - 247) / 2	204	A - 86	Prof. - 24	84	
ULTRABOX	(A - 31) / 2	(A - 181) / 2	220	A - 31	Prof. - 1	68	
			204		Prof. - 17	84	

Plastic
Plastik

Vantage-Q curved undersink insert

Osłona syfonu, zaokrąglona

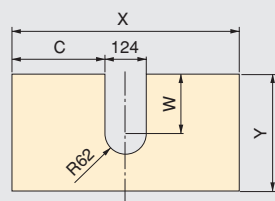
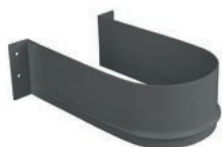

MODEL	C	V	W	X	Y	Z	
VERTEX	(A - 143) / 2	(A - 166) / 2	196	A - 19	Prof. - 10	63	
			180		Prof. - 26	81	
CONCEPT	(A - 143) / 2	(A - 166) / 2	196	A - 19	Prof. - 10	68	
			180		Prof. - 26	84	
VANTAGE-Q	(A - 210) / 2	(A - 211) / 2	180	A - 86	Prof. - 24	84	
ULTRABOX	(A - 31) / 2	(A - 155) / 2	196	A - 31	Prof. - 1	68	
			180		Prof. - 17	84	

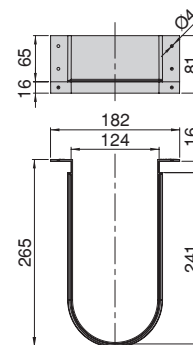

Finishing Wykończenie	Format Format	Cod.
White plastic Biały plastik	10 Ut/Szt	3044315
White plastic Biały plastik	100 Ut/Szt	3044415
Grey plastic Szary plastik	10 Ut/Szt	3044321
Grey plastic Szary plastik	100 Ut/Szt	3044421
Anthracite grey plastic Szaro-antracytowy plastik	100 Ut/Szt	3044423
Anthracite grey plastic Szaro-antracytowy plastik	10 Ut/Szt	3044323

Plastic
Plastik



Maseczka
do twarzy
z borowina
i masłem Shea

Maseczka
do twarzy
z borowina
i masłem Shea

Asprey
Scented
Candle

Asprey

Asprey
Cosmetics