

WARDROBES

SZAFY



Wardrobes

Accessories for wardrobe

- 159 Pull Down Wardrobe Rail Lift
- 174 Wardrobe interior wardrobe rails
- 168 Supports for wardrobe interior wardrobe rails
- 177 Hack accessories
- 191 Moka accessories
- 203 Keeper accessories
- 217 Self Accessories

Modular shelving

- 221 Modular structure Zero in kit form
- 225 Modular structure Zero
- 235 Lader Bookcases
- 237 Jagmet structure

Profiles and accessories for wooden doors

- 245 Adige handle profiles
- 246 Free Face handle profiles
- 247 Free Rapid handle profiles
- 248 Styl handle profiles
- 249 Rhodes handle profiles
- 249 Sparta handle profiles
- 250 Dust excluder strips
- 251 Door truss
- 252 Edging profiles Face

Aluminium doors

- 255 Plus profiles
- 258 Accessories for Plus profiles
- 262 Free doors

Szafy

Akcesoria do szafy

- 159 Wieszak składany
- 174 Drążki na wieszaki
- 168 Wsporniki do drążków na wieszaki
- 177 Akcesoria Hack
- 191 Akcesoria Moka
- 203 Akcesoria Keeper
- 217 Akcesoria Self

Regał modułowy

- 221 Struktura modułowa Zero w komplecie
- 225 Struktura modułowa Zero
- 235 Szafka Lader
- 237 System Jagmet

Profile i akcesoria do drzwi drewnianych

- 245 Profile uchwytowe Adige
- 246 Profile uchwytowe Free Face
- 247 Profile uchwytowe Free Rapid
- 248 Profile uchwytowe Styl
- 249 Profile uchwytowe Rhodes
- 249 Profile uchwytowe Sparta
- 250 Taśmy przeciwpyłowe
- 251 Napinacze do drzwi
- 252 Profile krawędziowe Face

Drzwi aluminiowe

- 255 Profile Plus
- 258 Akcesoria do profili Plus
- 262 Drzwi Free

SLING



PULL DOWN WARDROBE RAIL LIFT // WIESZAK SKŁADANY

Sling pull down wardrobe rail lift

Pantograf Sling

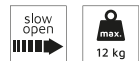

Width Szerokość	Finishing Wykończenie	Format Format	Cod.
450 - 600	Chrome plated Chromowane	1 Ut/Szt	7030011
600 - 830	Chrome plated Chromowane	1 Ut/Szt	7030111
830 - 1150	Chrome plated Chromowane	1 Ut/Szt	7030211
450 - 600	White plastic Biały plastik	1 Ut/Szt	7030015
600 - 830	White plastic Biały plastik	1 Ut/Szt	7030115
830 - 1150	White plastic Biały plastik	1 Ut/Szt	7030215
450 - 600	Titanium Tytanowy	1 Ut/Szt	7030052
600 - 830	Titanium Tytanowy	1 Ut/Szt	7030152
830 - 1150	Titanium Tytanowy	1 Ut/Szt	7030252

Plastic, Steel
Plastik, Stal

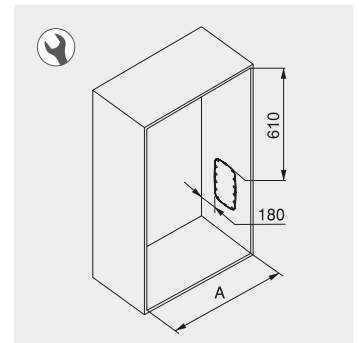
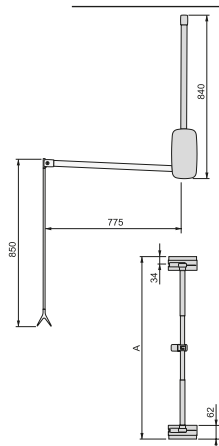

Side covers included to hide the installation screws.
Also available are cover caps in textile effect.
Includes mounting screws.
The handle bar has a fixing system that reduces its swing-back.
Central bar can be adjusted in width.
Integrated opening bumper stop.

W komplecie boczne osłony maskujące wkręty montażowe.
Dostępne są także osłony o powierzchni tekstylnej.
W komplecie wkręty montażowe.
Drażek uchwytu jest wyposażony w system mocujący, który ogranicza zakres odchylenia się drążka po jego opuszczeniu.
Szerokość drążka środkowego jest regulowana.
Zintegrowany odbojnik w otworze na ramiona pantografu.



PULL DOWN WARDROBE RAIL LIFT // WIESZAK SKŁADANY

Stopper for Sling pull down wardrobe rail lift

Ogranicznik do pantografu Sling



Allows Sling to be mounted to the back of the wardrobe.

Możliwość montowania drążka opuszczanego Sling do tylnej części szafy.

Finishing Wykończenie	Format Format	Cod.
White plastic Biały plastik	6 Ut/Szt	7030415
Silver painted Malowane aluminium	6 Ut/Szt	7030425
Titanium plastic Plastik tytanowy	6 Ut/Szt	7030438

Plastic
Plastik

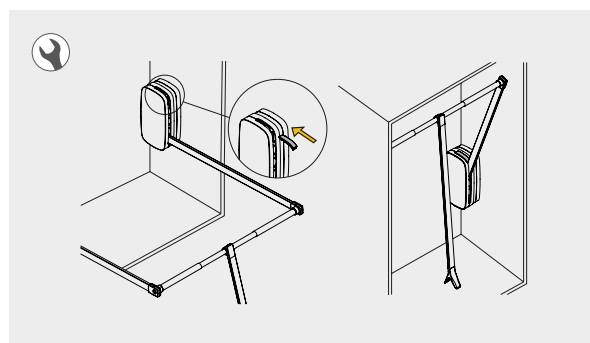

Side supplement for Sling pull down wardrobe rail lift

Wkładka boczna do pantografu Sling



x12

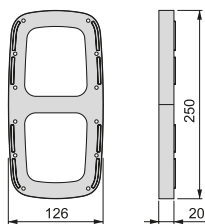

Finishing Wykończenie	Format Format	Cod.
White plastic Biały plastik	1 Pair/Kpl.	7067315
Silver painted Malowane aluminium	1 Pair/Kpl.	7067325
Titanium plastic Plastik tytanowy	1 Pair/Kpl.	7067338

Plastic
Plastik

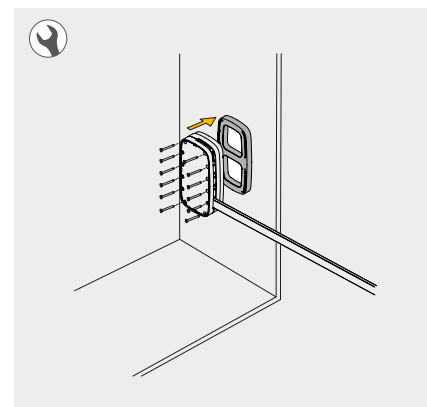

HANG



PULL DOWN WARDROBE RAIL LIFT // WIESZAK SKŁADANY

Hang pull down wardrobe rail lift

Pantograf Hang

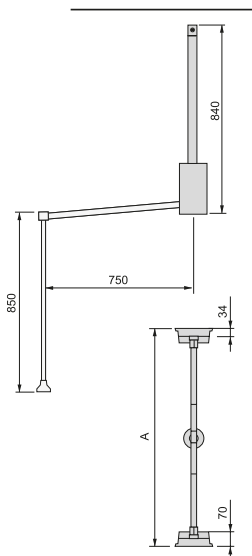

A	Finishing Wykończenie	Format Format	Cod.
450 - 600	Chrome plated Chromowane		1 Ut/Szt 9283711
600 - 830	Chrome plated Chromowane		1 Ut/Szt 9283811
830 - 1150	Chrome plated Chromowane		1 Ut/Szt 9283911
450 - 600	Moka painted Malowane na kolor mokka		1 Ut/Szt 9283713
600 - 830	Moka painted Malowane na kolor mokka		1 Ut/Szt 9283813
830 - 1150	Moka painted Malowane na kolor mokka		1 Ut/Szt 9283913
450 - 600	Black painted Malowane na czarno		1 Ut/Szt 9283714
600 - 830	Black painted Malowane na czarno		1 Ut/Szt 9283814
830 - 1150	Black painted Malowane na czarno		1 Ut/Szt 9283914

Plastic, Steel
Plastik, Stal

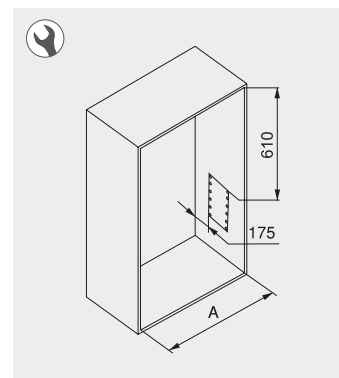

Hang pull down wardrobe rail lift wall-mounted

System Hang mocowany do ściany

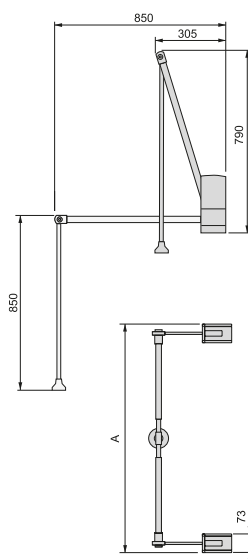

A	Finishing Wykończenie	Format Format	Cod.
600-830	Chrome plated Chromowane		1 Ut/Szt 6037811

Plastic, Steel
Plastik, Stal





PULL DOWN WARDROBE RAIL LIFT // WIESZAK SKŁADANY

Stopper for Hang pull down wardrobe rail lift

Ogranicznik do pantografu Hang

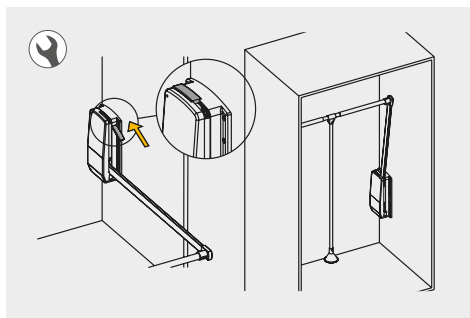

Finishing Wykończenie	Format Format	Cod.
Silver painted Malowane aluminium	6 Ut/Szt	8285425

Plastic
Plastik

Side supplement for Hang pull down wardrobe rail lift

Wkładka boczna do pantografu Hang



x12

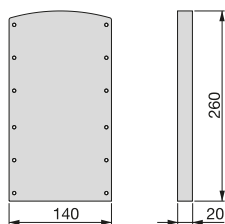

Finishing Wykończenie	Format Format	Cod.
Moka painted Malowane na kolor mokka	1 Pair/Kpl.	7085013
Black plastic Czarny plastik	1 Pair/Kpl.	7085017
Silver painted Malowane aluminium	1 Pair/Kpl.	7085025

Plastic
Plastik



WARDROBE INTERIOR WARDROBE RAILS // DRAŻKI NA WIESZAKI

Luxe rectangular wardrobe rail kit

Drażek kwadratowy do szafy Luxe

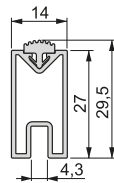

Longitude Długość	Finishing Wykończenie	Format Format	Cod.
2,35 m	Moka painted Malowane na kolor mokka		10 Ut/Szt 7100813
2,35 m	Matt anodized Anodyzowany mat		10 Ut/Szt 7100862

Aluminium
Aluminium

Longitude Długość	Finishing Wykończenie	Format Format	Cod.
1 m	Textured black painted Teksturowana czern		10 Ut/Szt 7102154
2,35 m	Textured black painted Teksturowana czern		10 Ut/Szt 7102254

Aluminium
Aluminium



Can be cut to size.
Możliwość personalizacji.

With semi-hard P.V.C profile to avoid coathanger noise and scratches.



Z półtwardym profilem P.V.C, aby uniknąć hałasu i zarysowań powłoki.

Ø28 round wardrobe rail

Okrągły drażek do szafy Ø28

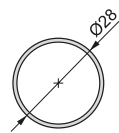

Longitude Długość	Finishing Wykończenie	Format Format	Cod.
2,35 m	Moka painted Malowane na kolor mokka		10 Ut/Szt 6057813
2,35 m	Black painted Malowane na czarno		10 Ut/Szt 6057814
2,35 m	Matt anodized Anodyzowany mat		10 Ut/Szt 6057862
2,35 m	Titanium painted Malowane na tytanowy		10 Ut/Szt 6057873

Aluminium
Aluminium



Can be cut to size.
Możliwość personalizacji.

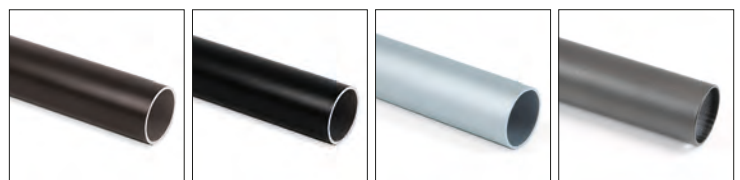

WARDROBE INTERIOR WARDROBE RAILS // DRĄŻKI NA WIESZAKI

Silk wardrobe rail kit

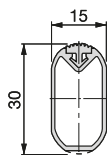

Drążek do szafy Silk



Can be cut to size.
Możliwość personalizacji.

With semi-hard P.V.C profile to avoid coathanger noise and scratches.

Z półtwardym profilem P.V.C, aby uniknąć hałasu i zarysowań powłoki.

Longitude Długość	Finishing Wykończenie	Format Format	Cod.
2,35 m	Black painted Malowane na czarno		10 Ut/Szt 6072114
2,35 m	Matt anodized Anodyzowany mat		10 Ut/Szt 6072162

Aluminium
Aluminium

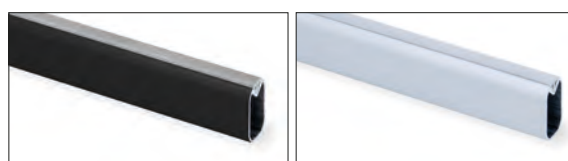

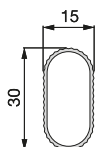

Aluminium wardrobe rail

Aluminiowy drążek do szafy



Can be cut to size.
Możliwość personalizacji.

Longitude Długość	Finishing Wykończenie	Format Format	Cod.
2,35 m	Matt anodized Anodyzowany mat		10 Ut/Szt 6220362
3,9 m	Matt anodized Anodyzowany mat		15 Ut/Szt 6220262

Aluminium
Aluminium

Steel wardrobe rail

Stalowy drążek do szafy

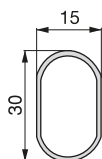

Can be cut to size.
Możliwość personalizacji.

Longitude Długość	Finishing Wykończenie	Format Format	Cod.
2,35 m	Chrome plated Chromowane		10 Ut/Szt 7009411

Steel
Stal

SUPPORTS FOR WARDROBE INTERIOR WARDROBE RAILS // WSPORNIKI DO DRAŻKÓW NA WIESZAKI

Luxe wardrobe rail support set

Zestaw uchwyty do szafy Luxe

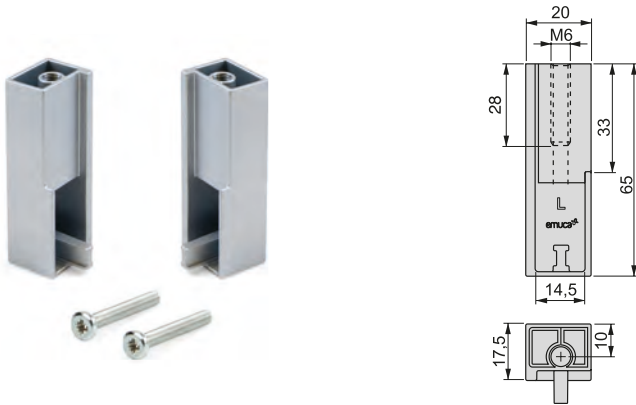

Finishing Wykończenie	Format Format	Cod.
Moka painted Malowane na kolor mokka	10 Pair/Kpl.	7102013
Silver painted Malowane aluminium	10 Pair/Kpl.	7102025
Textured black painted Teksturowana czerń	10 Pair/Kpl.	7102054

Zamak
Znal

To calculate the measurement of the bar, subtract 10 mm from the inter-axis of the end support.

W celu obliczenia wymiaru drążka, od rozstawu osi wspornika należy odjąć 10 mm.

Luxe wardrobe rail central support

Środkowy uchwyty drążka do szafy Luxe

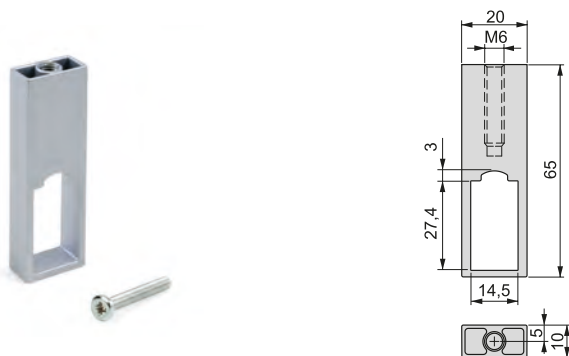

Finishing Wykończenie	Format Format	Cod.
Moka painted Malowane na kolor mokka	20 Ut/Szt	7100313
Silver painted Malowane aluminium	20 Ut/Szt	7100325
Textured black painted Teksturowana czerń	20 Ut/Szt	7100354

Zamak
Znal



SUPPORTS FOR WARDROBE INTERIOR WARDROBE RAILS // WSPORNIKI DO DRAŻKÓW NA WIESZAKI

Luxe wardrobe rail angular support

Uchwyt kątowy drążka do szafy

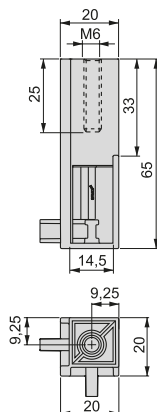

Finishing Wykończenie	Format Format	Cod.
Moka painted Malowane na kolor mokka	20 Ut/Szt	7100213
Silver painted Malowane aluminium	20 Ut/Szt	7100225
Textured black painted Teksturowana czerń	20 Ut/Szt	7100254

Zamak
Znal

Luxe wardrobe rail support

Uchwyt do drążka do szafy Luxe

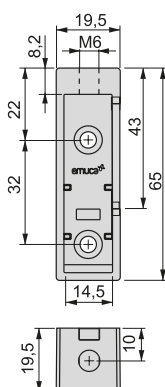

Hand Uchwyty	Finishing Wykończenie	Format Format	Cod.
Left Lewy	Silver painted Malowane aluminium	100 Ut/Szt	7100425
Right Prawy	Silver painted Malowane aluminium	100 Ut/Szt	7100525
Left Lewy	Moka plastic Plastik w kolorze mokka	100 Ut/Szt	7100443
Right Prawy	Moka plastic Plastik w kolorze mokka	100 Ut/Szt	7100543

Plastic
Plastik

To calculate the measurement of the rail subtract 11 mm from the internal width.

Aby obliczyć wymiar szyny, od wewnętrznej szerokości należy odjąć 11 mm.



SUPPORTS FOR WARDROBE INTERIOR WARDROBE RAILS // WSPORNIKI DO DRAŻKÓW NA WIESZAKI

Ø28 wardrobe rail support set

Zestaw uchwytów do drążka do szafy Ø28

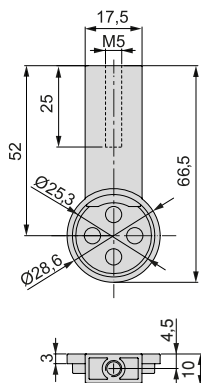

To calculate the measurement of the bar, subtract 3 mm from the inter-axis of the end support.

W celu obliczenia wymiaru drążka, od rozstawu osi wspornika należy odjąć 3 mm.

Finishing Wykończenie	Format Format	Cod.
Moka painted Malowane na kolor mokka	10 Pair/Kpl.	7922513
Black painted Malowane na czarno	10 Pair/Kpl.	7922514
Silver painted Malowane aluminium	10 Pair/Kpl.	7922525
Titanium painted Malowane na tytanowy	10 Pair/Kpl.	7922573

Zamek
Znal

Ø28 wardrobe rail central support

Środkowy uchwyt drążka do szafy Ø28

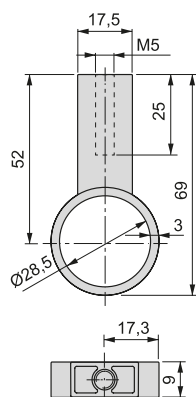

Finishing Wykończenie	Format Format	Cod.
Moka painted Malowane na kolor mokka	20 Ut/Szt	7919713
Black painted Malowane na czarno	20 Ut/Szt	7919714
Silver painted Malowane aluminium	20 Ut/Szt	7919725
Titanium painted Malowane na tytanowy	20 Ut/Szt	7919773

Zamek
Znal

Ø28 wardrobe rail lateral support

Boczny uchwyt drążka do szafy Ø28

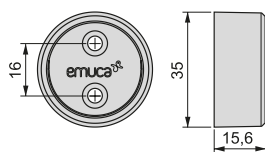

Finishing Wykończenie	Format Format	Cod.
Moka plastic Plastik w kolorze mokka	50 Ut/Szt	7919843
Grey plastic Szary plastik	50 Ut/Szt	7919821
Black plastic Czarny plastik	50 Ut/Szt	7919817

Plastic, Zamek
Plastik, Znal

To calculate the measurement of the rail subtract 6 mm from the internal width.

W celu obliczenia wymiaru drążka, należy odjąć 6 mm od i wyposażeniu szerokości.



SUPPORTS FOR WARDROBE INTERIOR WARDROBE RAILS // WSPORNIKI DO DRĄŻKÓW NA WIESZAKI

Silk wardrobe rail support set

Zestaw uchwytów do drążka do szafy Silk

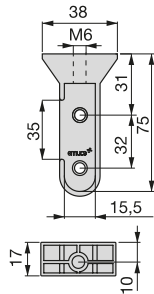

Finishing Wykończenie	Format Format	Cod.
Black painted Malowane na czarno	10 Pair/Kpl.	7101014
Silver painted Malowane aluminium	10 Pair/Kpl.	7101025

Plastic
Plastik



To calculate the measurement of the rail subtract 7 mm from the internal width.

W celu obliczenia wymiaru drążka, należy odjąć 7 mm od i wyposażeniej szerokości.

Silk wardrobe rail central support

Środkowy uchwyt drążka do szafy Silk

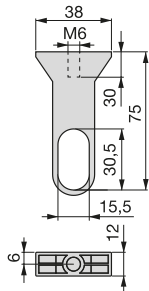

Finishing Wykończenie	Format Format	Cod.
Black painted Malowane na czarno	20 Ut/Szt	6003114
Silver painted Malowane aluminium	20 Ut/Szt	6003125

Plastic
Plastik

Silk wardrobe rail angular support

Uchwyt kątowy drążka do szafy Silk

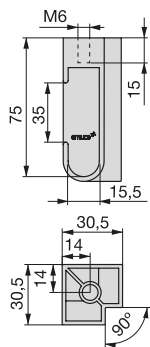

Finishing Wykończenie	Format Format	Cod.
Black painted Malowane na czarno	20 Ut/Szt	6003214
Silver painted Malowane aluminium	20 Ut/Szt	6003225

Plastic
Plastik

Wardrobe rail lateral support 90168

Boczny uchwyt drążka do szafy 90168

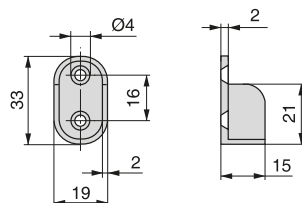

Finishing Wykończenie	Format Format	Cod.
Nickel plated Niklowane	500 Ut/Szt	9016807
Silver painted Malowane aluminium	500 Ut/Szt	9016825

Zamak
Znal

SUPPORTS FOR WARDROBE INTERIOR WARDROBE RAILS // WSPORNIKI DO DRAŻKÓW NA WIESZAKI

Direct assembly wardrobe rail lateral support

Boczny uchwyt do drążka do szafy, montaż bezpośredni

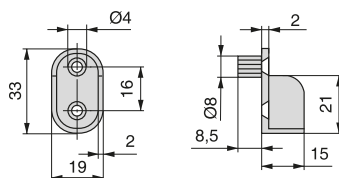

Finishing Wykończenie	Format Format	Cod.
Nickel plated Niklowane	500 Ut/Szt	9016707

Zamak
Znal

Wardrobe rail lateral support 40070

Boczny uchwyt drążka do szafy 40070

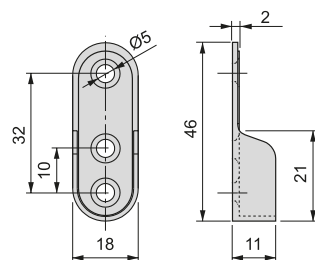

Finishing Wykończenie	Format Format	Cod.
Nickel plated Niklowane	500 Ut/Szt	4007007

Steel
Stal

Wardrobe rail lateral support 70143

Boczny uchwyt drążka do szafy 70143

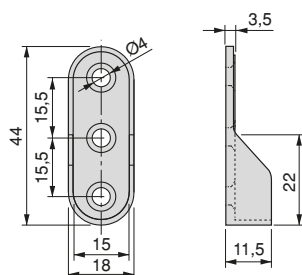

Finishing Wykończenie	Format Format	Cod.
Nickel plated Niklowane	500 Ut/Szt	7014307

Zamak
Znal

Wardrobe rail lateral support 71468

Boczny uchwyt drążka do szafy 71468

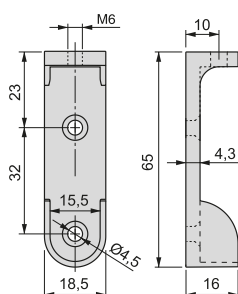

Finishing Wykończenie	Format Format	Cod.
Nickel plated Niklowane	250 Ut/Szt	7146807
Silver painted Malowane aluminium	250 Ut/Szt	7146825

Zamak
Znal

SUPPORTS FOR WARDROBE INTERIOR WARDROBE RAILS // WSPORNIKI DO DRĄŻKÓW NA WIESZAKI

Wardrobe rail lateral support 60474

Boczny uchwyt drążka do szafy 60474

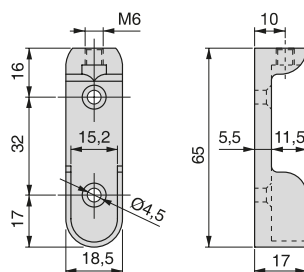

Finishing Wykończenie	Format Format	Cod.
Nickel plated Niklowane	200 Ut/Szt	6047407
Silver painted Malowane aluminium	200 Ut/Szt	6047425

Zamak
Znal

Wardrobe rail lateral support 60026

Boczny uchwyt drążka do szafy 60026

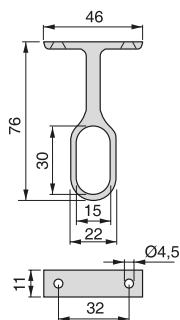

Finishing Wykończenie	Format Format	Cod.
Nickel plated Niklowane	300 Ut/Szt	6002607
Silver painted Malowane aluminium	300 Ut/Szt	6002625

Zamak
Znal

Wardrobe rail central support 81203

Środkowy uchwyt drążka do szafy 81203

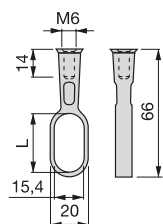

L	Finishing Wykończenie	Format Format	Cod.
30	Silver painted Malowane aluminium	500 Ut/Szt	8120325

Zamak
Znal

Wardrobe rail central support base

Podstawka pod środkowy uchwyt drążka do szafy

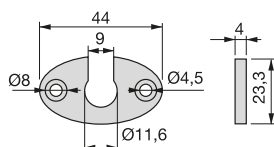

Finishing Wykończenie	Format Format	Cod.
Silver painted Malowane aluminium	500 Ut/Szt	8120425

Zamak
Znal

WARDROBE INTERIOR WARDROBE RAILS // DRĄŻKI NA WIESZAKI

Wardrobe hanging rail kit Silk

Zestaw drążków Silk



Longitude Długość	Finishing Wykończenie	Format Format	Cod.
1,15 m	Black painted Malowane na czarno	1 KIT/ Zestaw	7070014
0,75 m	Black painted Malowane na czarno	1 KIT/ Zestaw	7070114
1,15 m	Matt anodized Anodyzowany mat	1 KIT/ Zestaw	7070062
0,75 m	Matt anodized Anodyzowany mat	1 KIT/ Zestaw	7070162

Aluminium, Plastic
Aluminium, Plastik

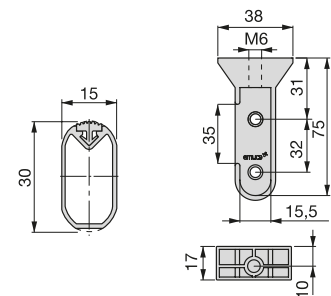

The kit includes everything needed to mount two 30x15 mm wardrobe bars Silk: the tube, the lateral supports, the assembly M6 screws.
The tube has a piece of PVC rubber co-extruded in order to avoid noise when moving the hangers.
The 1150 mm kits also include 2 central supports to provide the assembly with greater rigidity.

Zestaw zawiera wszystko, co jest potrzebne do montażu dwóch prętów do szafy Silk 30x15 mm: rurki, wspornik boczne i śruby M6 do montażu.
Rurka posiada współwytłaczaną gumę z PVC, aby wytłumić hałas wieszaków.
Zestawy 1150mm posiadają również 2 wsporniki centralne, aby zapewnić większą sztywność montażu.

Wardrobe hanging rail kit 30x15 mm aluminium

Zestaw drążków 30x15 mm aluminium



Longitude Długość	Finishing Wykończenie	Format Format	Cod.
0,75 m	Matt anodized Anodyzowany mat	1 KIT/ Zestaw	7070362
1,15 m	Matt anodized Anodyzowany mat	1 KIT/ Zestaw	7070262

Aluminium, Zamak
Aluminium, Znal

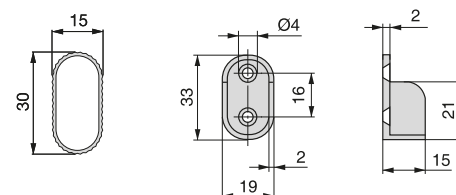

The kit includes two 30x15 mm wardrobe bars made from aluminium and the lateral supports for their installation.
The 1150 mm kits also include 2 central supports to provide the assembly with greater rigidity.

Zestaw zawiera dwa drążki do szafy 30x15 mm wykonane ze aluminium oraz wsporniki boczne do montażu.
W zestawach 1150mm znajdują się również 2 wsporniki środkowe, aby zapewnić większą sztywność całości.

WARDROBE INTERIOR WARDROBE RAILS // DRĄŻKI NA WIESZAKI

Wardrobe hanging rail kit 30x15 mm steel

Zestaw drążków 30x15 mm stal



Longitude Długość	Finishing Wykończenie	Format Format	Cod.
0,75 m	Chrome plated Chromowane	1 KIT/ Zestaw	7070511
1,15 m	Chrome plated Chromowane	1 KIT/ Zestaw	7070411

Steel, Zamak
Stal, Znak

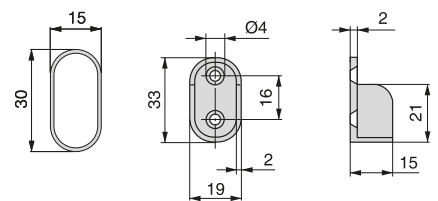

The kit includes two 30x15 mm wardrobe bars made from steel and the lateral supports for their installation.

The 1150 mm kits also include 2 central supports to provide the assembly with greater rigidity.

Zestaw zawiera dwa drążki do szafy 30x15 mm wykonane ze stali oraz wsporniki boczne do montażu.

W zestawach 1150 mm znajdują się również 2 wsporniki środkowe, aby zapewnić większą sztywność całości.

Wardrobe hanging rail kit round Ø28

Zestaw drążków okrągłych średnica Ø28



Longitude Długość	Finishing Wykończenie	Format Format	Cod.
0,75 m	Moka painted Malowane na kolor mokka	1 KIT/ Zestaw	7070713
1,15 m	Moka painted Malowane na kolor mokka	1 KIT/ Zestaw	7070613
0,75 m	Black painted Malowane na czarno	1 KIT/ Zestaw	7070714
1,15 m	Black painted Malowane na czarno	1 KIT/ Zestaw	7070614
0,75 m	Matt anodized Anodyzowany mat	1 KIT/ Zestaw	7070762
1,15 m	Matt anodized Anodyzowany mat	1 KIT/ Zestaw	7070662

Aluminium, Zamak
Aluminium, Znak

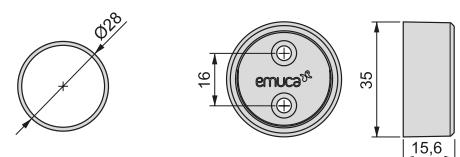

The kit includes everything needed to mount two D.28 mm wardrobe bars: the tube, the lateral supports, the assembly screws.

The 1150 mm kits also include 2 central supports to provide the assembly with greater rigidity.

Zestaw zawiera wszystko, co potrzebne do montażu dwóch prętów do szafy o średnicy 28 mm: rurkę, wsporniki boczne i śruby do montażu.

Zestawy 1150 mm zawierają również 2 wsporniki centralne, aby zapewnić większą sztywność montażu.

HACK



HACK ACCESSORIES // AKCESORIA HACK

Hack frame with runners

Hack rama z prowadnicami

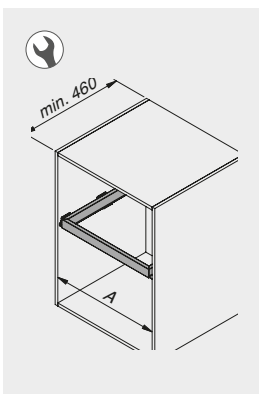
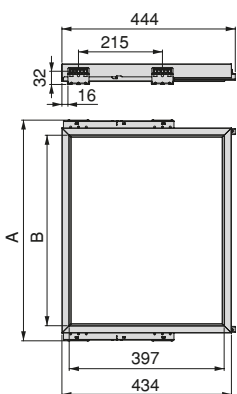
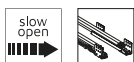

A	B	Finishing Wykończenie	Format Format	Cod.
564 - 598	487 (M60)	Textured black painted Teksturowana czerń	2 KIT/Zestaw	7110054
623 - 657	546	Textured black painted Teksturowana czerń	2 KIT/Zestaw	7110154
682 - 716	605	Textured black painted Teksturowana czerń	2 KIT/Zestaw	7110254
741 - 775	664	Textured black painted Teksturowana czerń	2 KIT/Zestaw	7110354
764 - 798	687 (M80)	Textured black painted Teksturowana czerń	2 KIT/Zestaw	7110454
798 - 832	721	Textured black painted Teksturowana czerń	2 KIT/Zestaw	7110554
832 - 866	755	Textured black painted Teksturowana czerń	2 KIT/Zestaw	7110654
864 - 898	787 (M90)	Textured black painted Teksturowana czerń	2 KIT/Zestaw	7110754
923 - 957	846	Textured black painted Teksturowana czerń	2 KIT/Zestaw	7110854
982 - 1.016	905	Textured black painted Teksturowana czerń	2 KIT/Zestaw	7110954
1.041 - 1.075	964	Textured black painted Teksturowana czerń	2 KIT/Zestaw	7111054
564 - 598	487 (M60)	Textured stone color painted Malowany teksturowany kolor kamienia	2 KIT/Zestaw	7110049
623 - 657	546	Textured stone color painted Malowany teksturowany kolor kamienia	2 KIT/Zestaw	7110149
682 - 716	605	Textured stone color painted Malowany teksturowany kolor kamienia	2 KIT/Zestaw	7110249
741 - 775	664	Textured stone color painted Malowany teksturowany kolor kamienia	2 KIT/Zestaw	7110349
764 - 798	687 (M80)	Textured stone color painted Malowany teksturowany kolor kamienia	2 KIT/Zestaw	7110449
798 - 832	721	Textured stone color painted Malowany teksturowany kolor kamienia	2 KIT/Zestaw	7110549
832 - 866	755	Textured stone color painted Malowany teksturowany kolor kamienia	2 KIT/Zestaw	7110649
864 - 898	787 (M90)	Textured stone color painted Malowany teksturowany kolor kamienia	2 KIT/Zestaw	7110749
923 - 957	846	Textured stone color painted Malowany teksturowany kolor kamienia	2 KIT/Zestaw	7110849
982 - 1.016	905	Textured stone color painted Malowany teksturowany kolor kamienia	2 KIT/Zestaw	7110949
1.041 - 1.075	964	Textured stone color painted Malowany teksturowany kolor kamienia	2 KIT/Zestaw	7111049

Aluminium, Plastic
Aluminium, Plastik





HACK ACCESSORIES // AKCESORIA HACK

Wire drawer Hack for wardrobes

Wysuwany kosz Hack do szaf

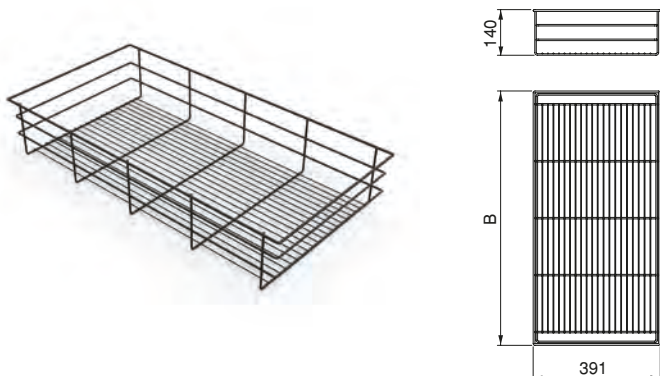

B	Finishing Wykończenie	Format Format	Cod.
482 (M60)	Textured black painted Teksturowana czerni	2 Ut/Szt	7111754
682 (M80)	Textured black painted Teksturowana czerni	2 Ut/Szt	7111854
782 (M90)	Textured black painted Teksturowana czerni	2 Ut/Szt	7111954
482 (M60)	Textured stone color painted Malowany teksturowany kolor kamienia	2 Ut/Szt	7111749
682 (M80)	Textured stone color painted Malowany teksturowany kolor kamienia	2 Ut/Szt	7111849
782 (M90)	Textured stone color painted Malowany teksturowany kolor kamienia	2 Ut/Szt	7111949

Steel
Stal

Shoe drawer Hack for wardrobes

Szuflada na buty Hack do szaf

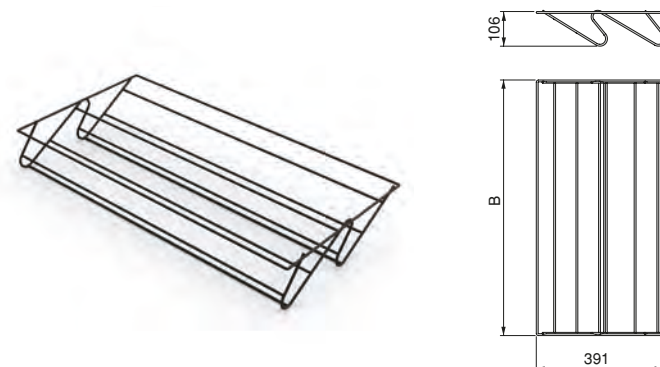

B	Finishing Wykończenie	Format Format	Cod.
482 (M60)	Textured black painted Teksturowana czerni	2 Ut/Szt	7111454
682 (M80)	Textured black painted Teksturowana czerni	2 Ut/Szt	7111554
782 (M90)	Textured black painted Teksturowana czerni	2 Ut/Szt	7111654
482 (M60)	Textured stone color painted Malowany teksturowany kolor kamienia	2 Ut/Szt	7111449
682 (M80)	Textured stone color painted Malowany teksturowany kolor kamienia	2 Ut/Szt	7111549
782 (M90)	Textured stone color painted Malowany teksturowany kolor kamienia	2 Ut/Szt	7111649

Steel
Stal





HACK ACCESSORIES // AKCESORIA HACK

Organizer Hack for wardrobes

Przegródkami Hack do szaf

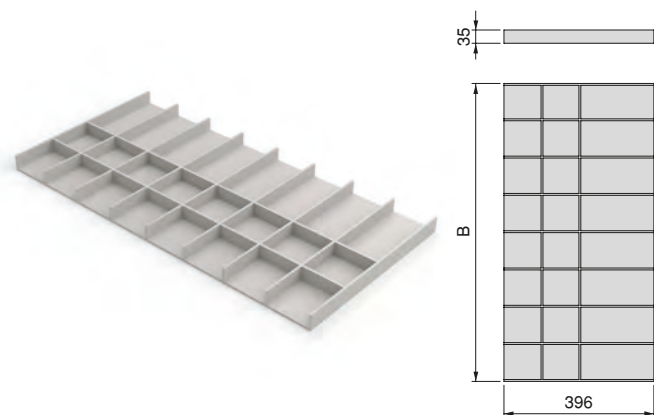

B	Finishing Wykończenie	Format Format	Cod.
487 (M60)	Textured stone color painted Malowany teksturowany kolor kamienia	1 Ut/Szt	7111149
687 (M80)	Textured stone color painted Malowany teksturowany kolor kamienia	1 Ut/Szt	7111249
787 (M90)	Textured stone color painted Malowany teksturowany kolor kamienia	1 Ut/Szt	7111349

Wood
Drewno

Tray Hack for wardrobes

Taca Hack do szaf

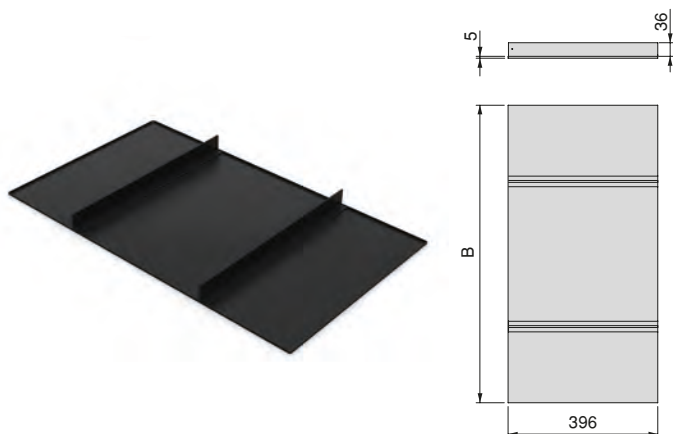

B	Finishing Wykończenie	Format Format	Cod.
487 (M60)	Textured black painted Teksturowana czerń	2 Ut/Szt	7112154
687 (M80)	Textured black painted Teksturowana czerń	2 Ut/Szt	7112254
787 (M90)	Textured black painted Teksturowana czerń	2 Ut/Szt	7112354
487 (M60)	Textured stone color painted Malowany teksturowany kolor kamienia	2 Ut/Szt	7112149
687 (M80)	Textured stone color painted Malowany teksturowany kolor kamienia	2 Ut/Szt	7112249
787 (M90)	Textured stone color painted Malowany teksturowany kolor kamienia	2 Ut/Szt	7112349

Steel
Stal





HACK ACCESSORIES // AKCESORIA HACK

Set of spacers for removable Hack

Zestaw podkładek Hack

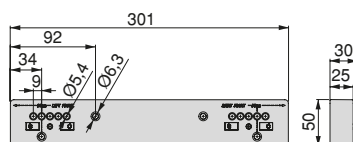

Finishing Wykończenie	Format Format	Cod.
Black plastic Czarny plastik	2 KIT/Zestaw	7112417
Stone colored plastic Plastik w kolorze kamienia	2 KIT/Zestaw	7112436

Plastic
Plastik

To be used with hinged doors or as a spacer for hollow modules.
Includes Ø6x13 Euro screws to fix the spacer to the slide.
Recommended screw Ø4x35.

Przeznaczony do drzwi z zawiasami lub jako rozpórka do modułów pustych.
Zawiera śruby Euro Ø6x13 do mocowania dystansera do prowadnicy.
Zalecany wkręt Ø4x35.

Basket Hack Fabric Box for wardrobes

Kosz Hack Fabric Box do szaf

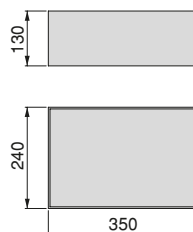
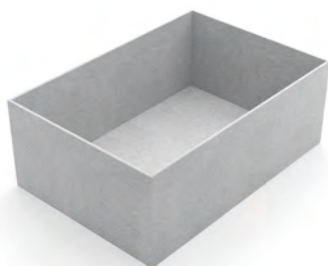

Finishing Wykończenie	Format Format	Cod.
Grey textil effect Efekt szarej tkaniny	6 Ut/Szt	7112827

Fabric
Tkanina

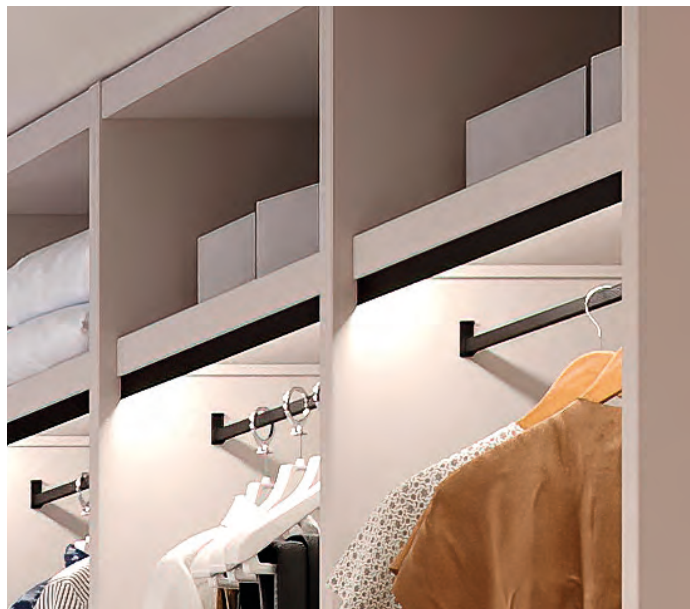





HACK ACCESSORIES // AKCESORIA HACK

Set of 7 trousers rods Hack for wardrobes

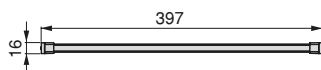
Zestaw 7 wieszaków na spodnie Hack do szaf



N° pieces Liczba elementów	Finishing Wykończenie	Format Format	Cod.
7 units 7 sztuk	Textured stone color painted Malowany teksturowany kolor kamienia		2 LOT/Partia 7112049
7 units 7 sztuk	Textured black painted Teksturowana czerń		2 LOT/Partia 7112054

Aluminium, Plastic
Aluminium, Plastik

Auxiliary tray Hack for wardrobes

Dodatkowa taca Hack do szaf

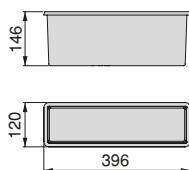

Finishing Wykończenie	Format Format	Cod.
Transparent / not defined Przezroczyste / nieokreślone		2 Ut/Szt 7112920

Plastic
Plastik





HACK ACCESSORIES // AKCESORIA HACK

Hack pull out lateral shoe rack

Wysuwana boczna szuflada na buty do wnętrza szafy Hack



Hand Uchwyty	Finishing Wykończenie	Format Format	Cod.
Right Prawy	Textured black painted Teksturowana czern	■	1 Ut/Szt 7112654
Left Lewy	Textured black painted Teksturowana czern	■	1 Ut/Szt 7112754
Right Prawy	Textured stone color painted Malowany teksturowany kolor kamienia	■	1 Ut/Szt 7112649
Left Lewy	Textured stone color painted Malowany teksturowany kolor kamienia	■	1 Ut/Szt 7112749

Steel
Stal

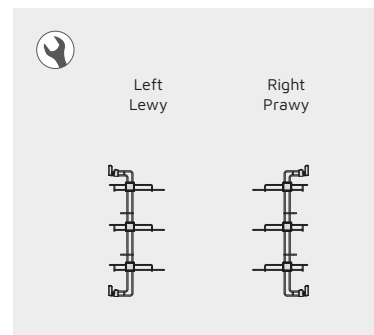
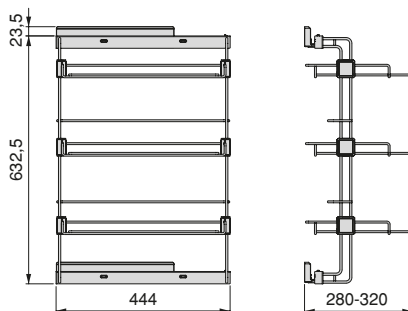
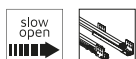



HACK ACCESSORIES // AKCESORIA HACK

Pull-out trouser rack

Wysuwany wieszak na spodnie

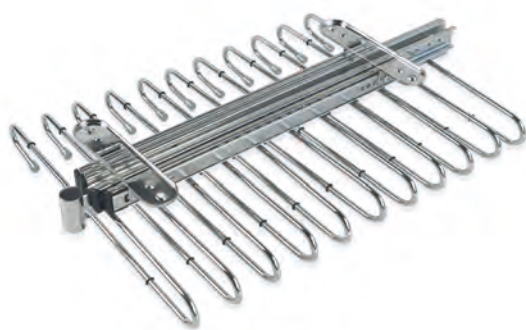

Finishing Wykończenie	Format Format	Cod.
Chrome plated Chromowane	1 Ut/Szt	7017811
Black painted Malowane na czarno	1 Ut/Szt	7017814
Stone colored plastic Plastik w kolorze kamienia	1 Ut/Szt	7017836

Steel
Stal

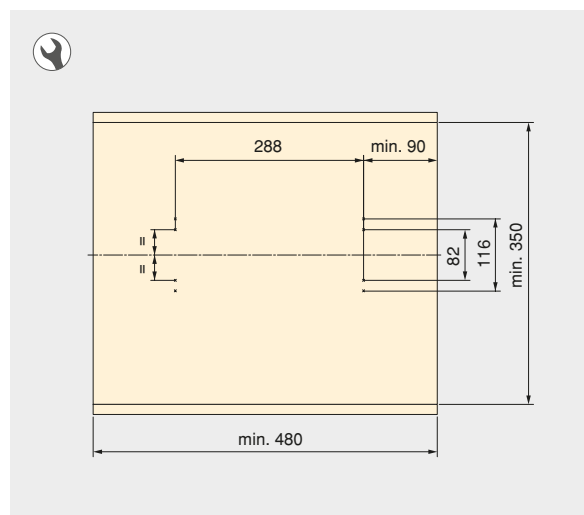
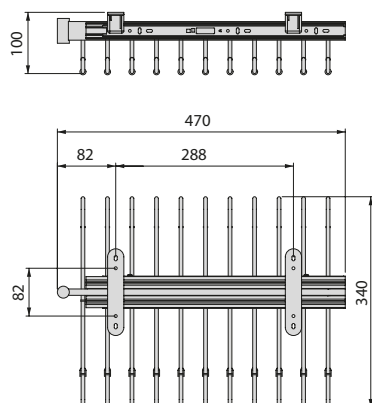

MOKA



MOKA ACCESSORIES // AKCESORIA MOKA

Moka frame with runners

Moka rama z prowadnicami

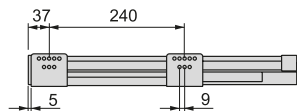
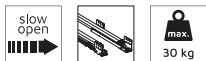

A	B	Finishing Wykończenie	Format Format	Cod.
564 - 614	484	Moka painted Malowane na kolor mokka	1 Ut/Szt	6930013
614 - 664	534	Moka painted Malowane na kolor mokka	1 Ut/Szt	6929913
664 - 714	584	Moka painted Malowane na kolor mokka	1 Ut/Szt	6930113
714 - 764	634	Moka painted Malowane na kolor mokka	1 Ut/Szt	6930613
764 - 814	684	Moka painted Malowane na kolor mokka	1 Ut/Szt	6930213
814 - 864	734	Moka painted Malowane na kolor mokka	1 Ut/Szt	6930713
864 - 914	784	Moka painted Malowane na kolor mokka	1 Ut/Szt	6930313
914 - 964	834	Moka painted Malowane na kolor mokka	1 Ut/Szt	6930813
964 - 1.014	884	Moka painted Malowane na kolor mokka	1 Ut/Szt	6930413
1.014 - 1.064	934	Moka painted Malowane na kolor mokka	1 Ut/Szt	6930913
1.064 - 1.114	984	Moka painted Malowane na kolor mokka	1 Ut/Szt	6930513

Aluminium, Plastic
Aluminium, Plastik

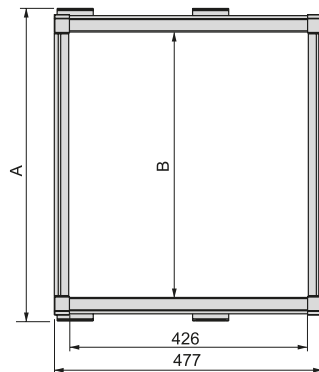
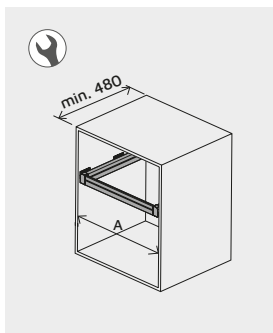

Set of spacers for removable Moka

Zestaw podkładek (przód i tył)

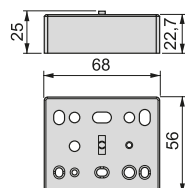

Finishing Wykończenie	Format Format	Cod.
Moka plastic Plastik w kolorze mokka	4 Pair/Kpl.	6939943

Plastic
Plastik

To be used with hinged doors or as a spacer for hollow modules.
Recommended screw Ø4x40.

Przeznaczony do drzwi z zawiasami lub jako rozpórka do modułów pus-
tych.
Zalecany wkręt Ø4x40.

MOKA ACCESSORIES // AKCESORIA MOKA

Metallic drawer Moka for wardrobes

Szuflada metalowa Moka do szaf



B	Finishing Wykończenie	Format Format	Cod.
475	Moka painted Malowane na kolor mokka	1 Ut/Szt	6932013
675	Moka painted Malowane na kolor mokka	1 Ut/Szt	6932113
775	Moka painted Malowane na kolor mokka	1 Ut/Szt	6932213

Steel
Stal

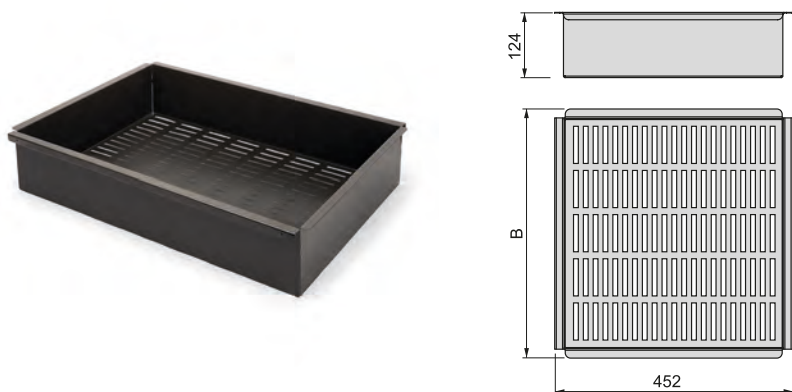

MOKA ACCESSORIES // AKCESORIA MOKA

Wire drawer Moka for wardrobes

Wysuwany kosz Moka do szaf

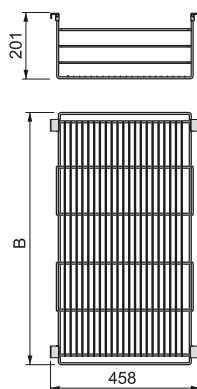

B	Finishing Wykończenie	Format Format	Cod.
475	Moka painted Malowane na kolor mokka	2 Ut/Szt	6933013
675	Moka painted Malowane na kolor mokka	2 Ut/Szt	6933113
775	Moka painted Malowane na kolor mokka	2 Ut/Szt	6933213

Steel
Stal

Organizer drawer Moka for wardrobes

Szuflada z przegródkami Moka do szaf

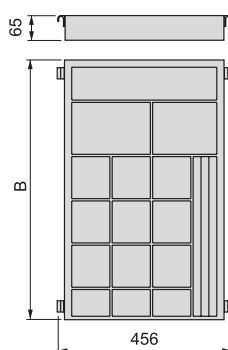

B	Finishing Wykończenie	Format Format	Cod.
483	Walnut wood Drewno orzechowe	1 Ut/Szt	6931075
683	Walnut wood Drewno orzechowe	1 Ut/Szt	6931175
783	Walnut wood Drewno orzechowe	1 Ut/Szt	6931275

Wood
Drewno



MOKA ACCESSORIES // AKCESORIA MOKA

Shoe drawer Moka for wardrobes

Szuflada na buty Moka do szaf

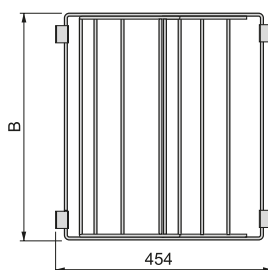
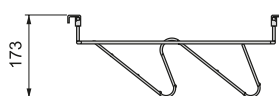

B	Finishing Wykończenie	Format Format	Cod.
475	Moka painted Malowane na kolor mokka	2 Ut/Szt	6937013
675	Moka painted Malowane na kolor mokka	2 Ut/Szt	6937113
775	Moka painted Malowane na kolor mokka	2 Ut/Szt	6937213

Steel
Stal



MOKA ACCESSORIES // AKCESORIA MOKA

Basket Moka for wardrobes

Kosz Moka do szaf

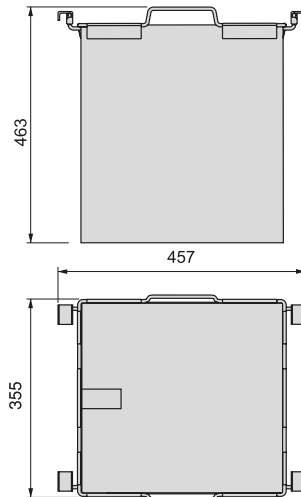

B	Finishing Wykończenie	Format Format	Cod.
355	Moka painted Malowane na kolor mokka	1 Ut/Szt	6934213

Fabric, Steel
Stal, Tkanina

Auxiliary tray Moka for wardrobes

Dodatkowa taca Moka do szaf

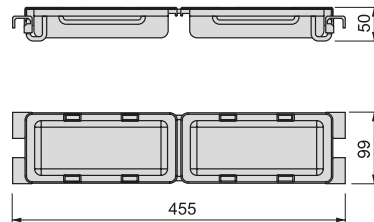

B	Finishing Wykończenie	Format Format	Cod.
99	Moka painted Malowane na kolor mokka	1 Ut/Szt	6939613

Aluminium, Plastik
Aluminium, Plastik



MOKA ACCESSORIES // AKCESORIA MOKA

Set of 7 trousers rods Moka for wardrobes

Zestaw 7 wieszaków na spodnie Moka do szaf



N° pieces Liczba elementów	Finishing Wykończenie	Format Format	Cod.
7 units 7 sztuk	Moka painted Malowane na kolor mokka		1 LOT/Partia 6934013

Aluminium, Plastic
Aluminium, Plastik

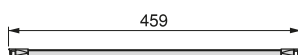

Hanging clip Moka for wardrobes

Wieszak zaciskowy Moka do szaf



Finishing Wykończenie	Format Format	Cod.
Moka plastic Plastik w kolorze mokka		10 Ut/Szt 6934143

Plastic
Plastik

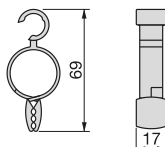

MOKA ACCESSORIES // AKCESORIA MOKA

Moka pull out shoe rack drawer

Zestaw wysuwanych szuflad na buty Moka



A	M	Finishing Wykończenie	Format Format	Cod.
564 - 594	600 mm	Moka painted Malowane na kolor mokka		1 Ut/Szt 6936013
764 - 794	800 mm	Moka painted Malowane na kolor mokka		1 Ut/Szt 6936113
864 - 894	900 mm	Moka painted Malowane na kolor mokka		1 Ut/Szt 6936213

Steel
Stal

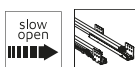
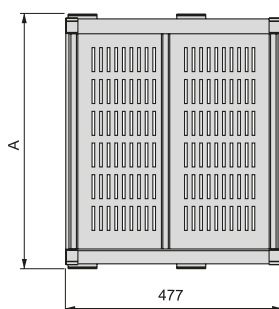
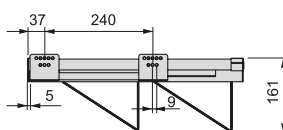

MOKA ACCESSORIES // AKCESORIA MOKA

Moka extractable hanger for wardrobe

Wysuwany wieszak Moka do szafy

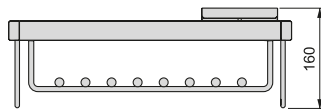
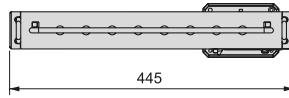

Finishing Wykończenie	Format Format	Cod.
Moka painted Malowane na kolor mokka	1 Ut/Szt	6938713

Aluminium, Plastic
Aluminium, Plastik



Moka extractable lateral tie rack

Wysuwany boczny wieszak na krawaty Moka

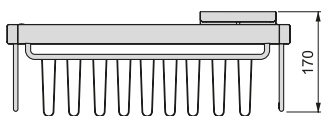
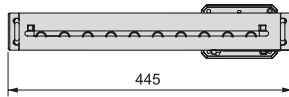

Finishing Wykończenie	Format Format	Cod.
Moka painted Malowane na kolor mokka	1 Ut/Szt	6938813

Aluminium, Plastic
Aluminium, Plastik



MOKA ACCESSORIES // AKCESORIA MOKA

Moka pull out lateral shoe rack

Wysuwana boczna szuflada na buty do wnętrza szafy Moka



Hand Uchwyty	Finishing Wykończenie	Format Format	Cod.
Left Lewy	Moka painted Malowane na kolor mokka	■	1 Ut/Szt 6938413
Right Prawy	Moka painted Malowane na kolor mokka	■	1 Ut/Szt 6938513

Steel
Stal

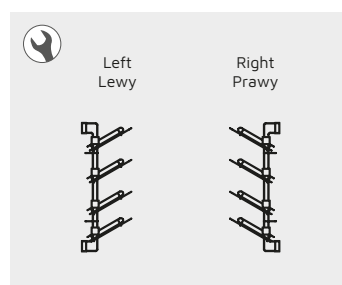
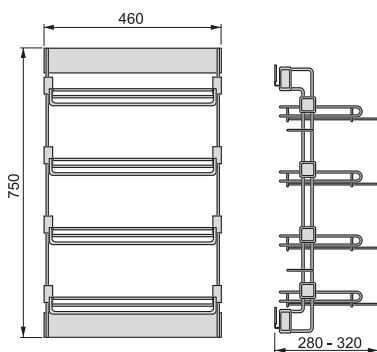
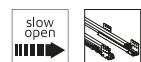



MOKA ACCESSORIES // AKCESORIA MOKA

Moka extractable mirror for inside wardrobe

Wysuwane lustro do szafy Moka

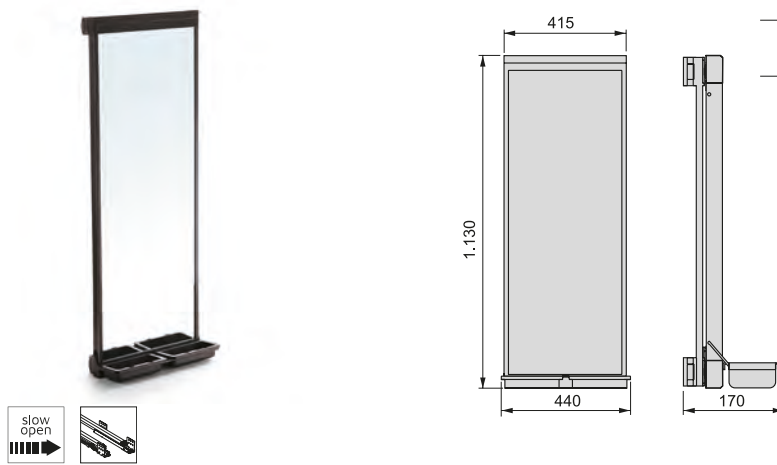

Width Szerokość	Finishing Wykończenie	Format Format	Cod.
440	Moka painted Malowane na kolor mokka	1 Ut/Szt	6938613

Aluminium, Plastic
Aluminium, Plastik

Pull-out mirror for inside wardrobe.

Wysuwane lustro do szafy

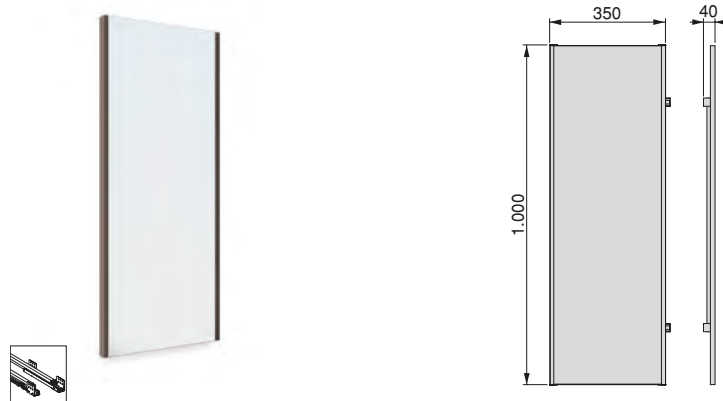

Finishing Wykończenie	Format Format	Cod.
Moka painted Malowane na kolor mokka	1 Ut/Szt	7018013
Silver painted Malowane aluminium	1 Ut/Szt	7018025

Glass, Plastic, Steel
Plastik, Stal, Szkło

pull-out trouser rack

Wysuwany wieszak

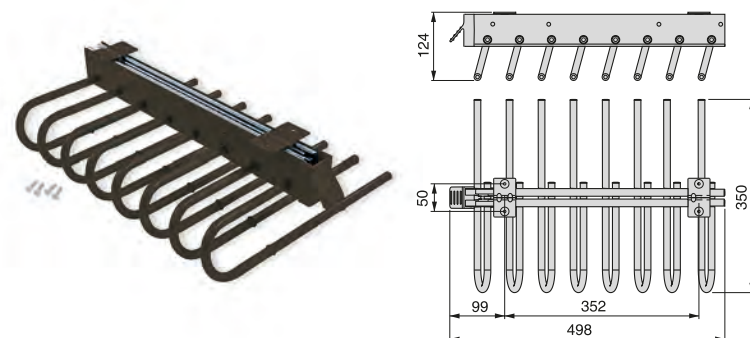

Hand Uchwyty	Finishing Wykończenie	Format Format	Cod.
Left Lewy	Moka painted Malowane na kolor mokka	1 Ut/Szt	6912813
Right Prawy	Moka painted Malowane na kolor mokka	1 Ut/Szt	6923413
Left Lewy	Silver painted Malowane aluminium	1 Ut/Szt	6912825
Right Prawy	Silver painted Malowane aluminium	1 Ut/Szt	6923425

Plastic, Steel
Plastik, Stal

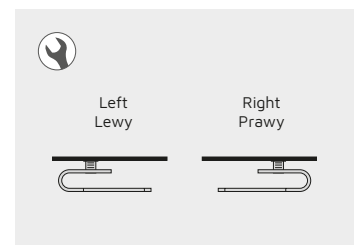

KEEPER



KEEPER ACCESSORIES // AKCESORIA KEEPER

Slide Keeper for wardrobes

Rama z prowadnicami Keeper do szaf

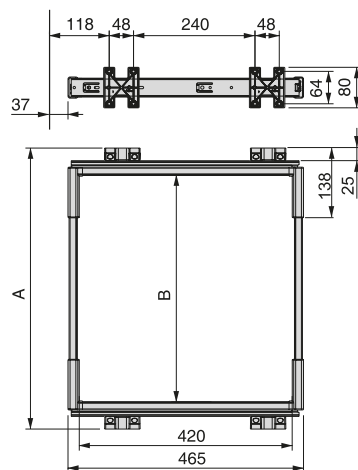

A	B	Finishing Wykończenie	Format Format	Cod.
555 - 710	448 - 609	Matt anodized Anodyzowany mat	1 Ut/Szt	7913362
710 - 855	603 - 758	Matt anodized Anodyzowany mat	1 Ut/Szt	7913462
855 - 1.000	748 - 893	Matt anodized Anodyzowany mat	1 Ut/Szt	7913562
1.000 - 1.150	893 - 1.043	Matt anodized Anodyzowany mat	1 Ut/Szt	7913662

Aluminium, Plastic
Aluminium, Plastik

Set of spacers for removable Keeper

Zestaw podkładek do wysuwanych prowadnic

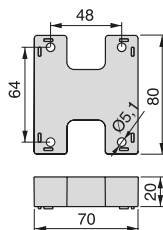

Finishing Wykończenie	Format Format	Cod.
Silver painted Melowane aluminium	12 Ut/Szt	7914025

Plastic
Plastik

To be used with hinged doors or as a spacer for hollow modules.

Przeznaczony do drzwi z zawiasami lub jako rozpórka do modułów pusty.

KEEPER ACCESSORIES // AKCESORIA KEEPER

Metallic drawer Keeper for wardrobes

Szuflada metalowa Keeper do szaf

L	Finishing Wykończenie	Format Format	Cod.
443	Silver painted Malowane aluminium	2 Ut/Szt	7913025
743	Silver painted Malowane aluminium	2 Ut/Szt	7919425

Aluminium, Plastic, Steel
Aluminium, Plastik, Stal

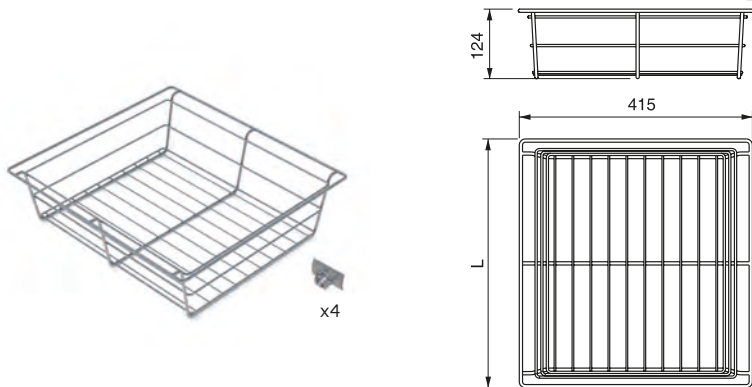

KEEPER ACCESSORIES // AKCESORIA KEEPER

Auxiliary shoe rack Keeper for wardrobes

Dodatkowa półka na buty Keeper do szaf

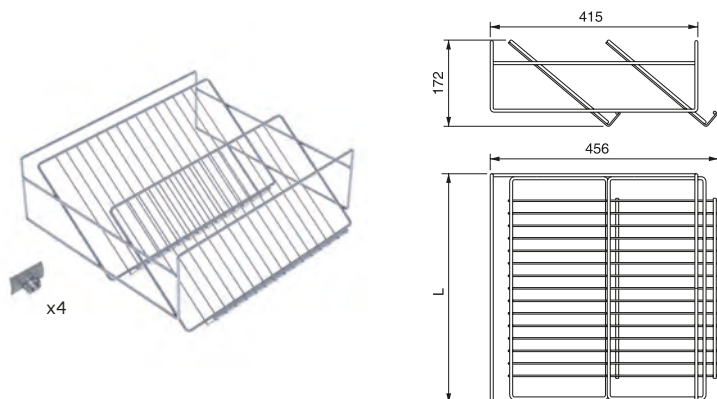

L	Finishing Wykończenie	Format Format	Cod.
458	Silver painted Malowane aluminium	2 Ut/Szt	7914125
608	Silver painted Malowane aluminium	2 Ut/Szt	7919525
758	Silver painted Malowane aluminium	2 Ut/Szt	7919625

Steel
Stal

Clothes basket Keeper for wardrobes

Kosz Keeper do szaf

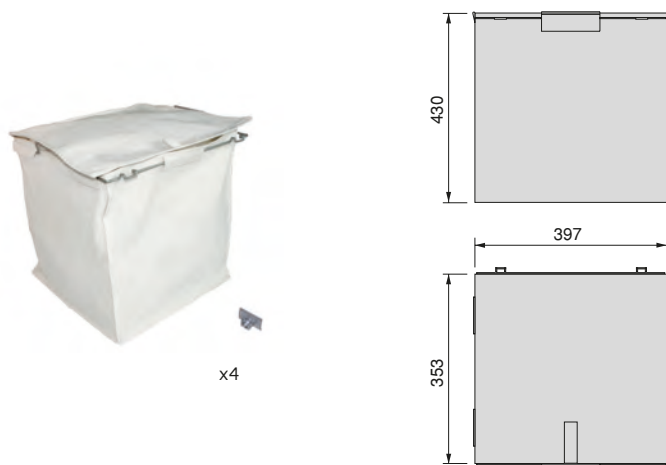

Finishing Wykończenie	Format Format	Cod.
Silver painted Malowane aluminium	1 Ut/Szt	7914325

Steel, Various
Różne, Stal



KEEPER ACCESSORIES // AKCESORIA KEEPER

Tray Keeper for wardrobes

Taca Keeper do szaf

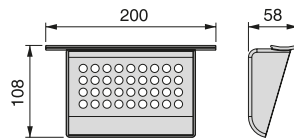

Finishing Wykończenie	Format Format	Cod.
Transparent / not defined Przezroczyste / nieokreślone	 2 Ut/Szt	7913220

Plastic
Plastik

Hook for tie rack Keeper for wardrobes

Haczyk do wieszaka na krawaty Keeper do szaf

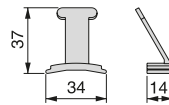

Finishing Wykończenie	Format Format	Cod.
Silver painted Malowane aluminium	 15 Ut/Szt	7914225

Plastic
Plastik



KEEPER ACCESSORIES // AKCESORIA KEEPER

Trouser hanging rack set Keeper for wardrobes

Zestaw wieszaka na spodnie Keeper do szaf



Finishing Wykończenie	Format Format	Cod.
Matt anodized Anodizowany mat	1 Ut/Szt	7913162

Aluminium, Plastik
Aluminium, Plastik

Hanging clip Keeper for wardrobes

Klips do zawieszania Keeper do szaf

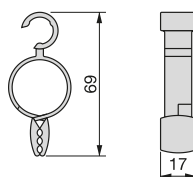

Finishing Wykończenie	Format Format	Cod.
Grey plastic Szary plastik	10 Ut/Szt	6915321

Plastic
Plastik



KEEPER ACCESSORIES // AKCESORIA KEEPER

Keeper extractable lateral tie rack for wardrobe

wysuwany wieszak Keeper na krawaty do montażu z boku szafy.

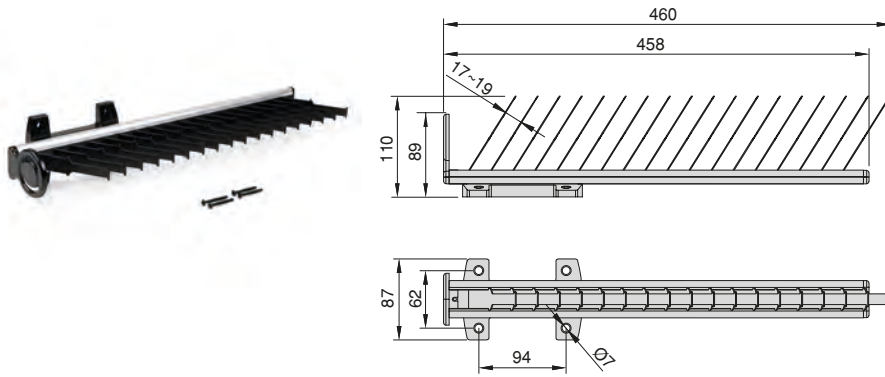

Finishing Wykończenie	Format Format	Cod.
Matt anodized Anodizowany mat	1 Ut/Szt	7919962
Aluminium, Plastic Aluminium, Plastik		

Keeper extractable lateral tie rack

Wysuwany boczny wieszak na krawaty Keeper

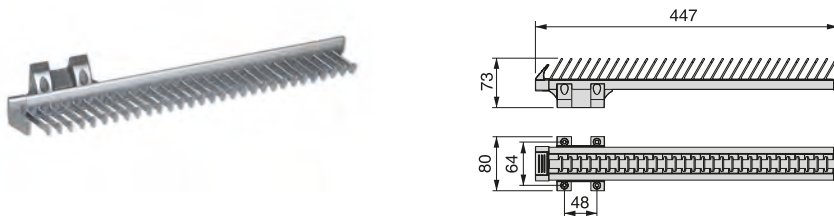

Finishing Wykończenie	Format Format	Cod.
Matt anodized Anodizowany mat	1 Ut/Szt	7913862
Aluminium, Plastic Aluminium, Plastik		



KEEPER ACCESSORIES // AKCESORIA KEEPER

Keeper extractable lateral shoe rack

Wysuwany stojak na buty Keeper

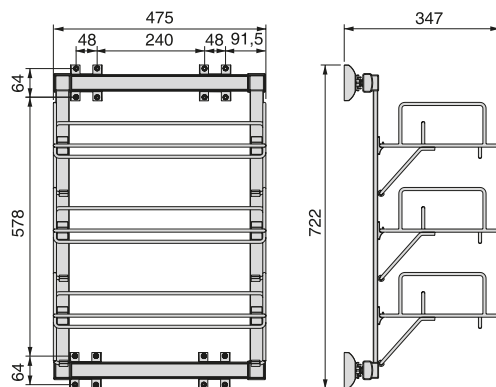

Finishing Wykończenie	Format Format	Cod.
Silver painted Malowane aluminium	1 Ut/Szt	7913725

Plastic, Steel
Plastik, Stal



KEEPER ACCESSORIES // AKCESORIA KEEPER

Keeper extractable lateral belt holder

Wysuwany boczny wieszak na paski Keeper

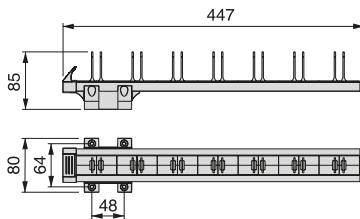

Finishing Wykończenie	Format Format	Cod.
Matt anodized Anodizowany mat	1 Ut/Szt	7913962

Aluminium, Plastic
Aluminium, Plastik

Pull-out hanging rail for Keeper wardrobe

Wysuwany drążek do szafy Keeper

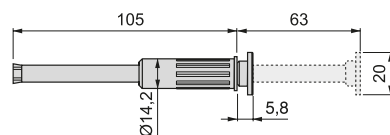

Finishing Wykończenie	Format Format	Cod.
Chrome plated Chromowane	1 Ut/Szt	7910611

Steel
Stal

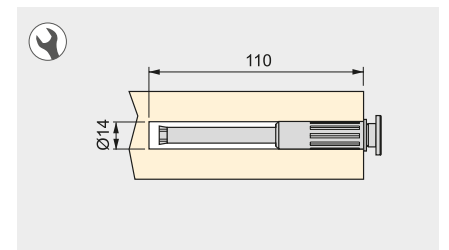

KEEPER ACCESSORIES // AKCESORIA KEEPER

Keeper extractable hanger for wardrobe

Wysuwany wieszak Keeper do szafy

Longitude Długość	Finishing Wykończenie	Format Format	Cod.
350	Black painted Malowane na czarno		1 Ut/Szt 6916314
350	Matt anodized Anodizowany mat		1 Ut/Szt 6916362

Aluminium
Aluminium



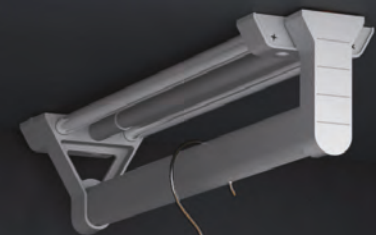

KEEPER ACCESSORIES // AKCESORIA KEEPER

Pull-out mirror for inside wardrobe.

Wysuwane lustro do szafy

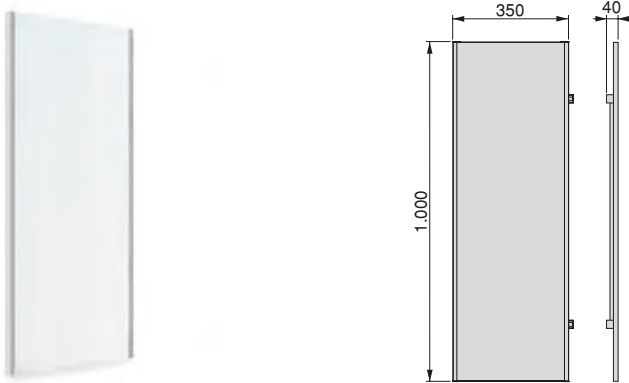

Finishing Wykończenie	Format Format	Cod.
Moka painted Malowane na kolor mokka	1 Ut/Szt	7018013
Silver painted Malowane aluminium	1 Ut/Szt	7018025

Glass, Plastic, Steel
Plastik, Stal, Szkło



pull-out trouser rack

Wysuwany wieszak

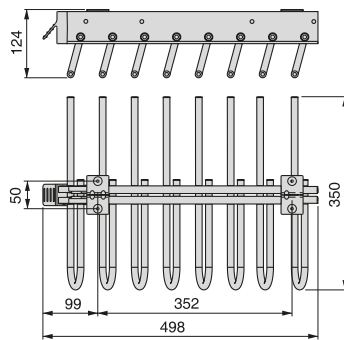

Hand Uchwyty	Finishing Wykończenie	Format Format	Cod.
Left Lewy	Moka painted Malowane na kolor mokka	1 Ut/Szt	6912813
Right Prawy	Moka painted Malowane na kolor mokka	1 Ut/Szt	6923413
Left Lewy	Silver painted Malowane aluminium	1 Ut/Szt	6912825
Right Prawy	Silver painted Malowane aluminium	1 Ut/Szt	6923425

Plastic, Steel
Plastik, Stal



Left
Lewy

Right
Prawy

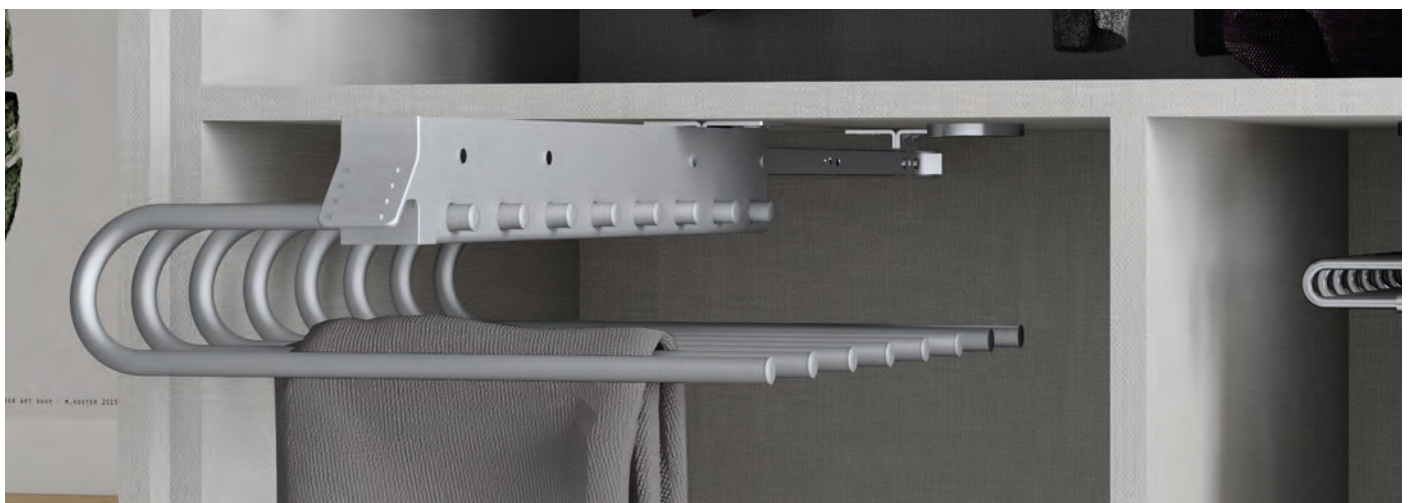

SELF



HACK ACCESSORIES // AKCESORIA HACK

Pull-out trouser rack

Wysuwany wieszak na spodnie



Finishing Wykończenie	Format Format	Cod.
Chrome plated Chromowane	1 Ut/Szt	7017811
Black painted Malowane na czarno	1 Ut/Szt	7017814
Stone colored plastic Plastik w kolorze kamienia	1 Ut/Szt	7017836

Steel
Stal

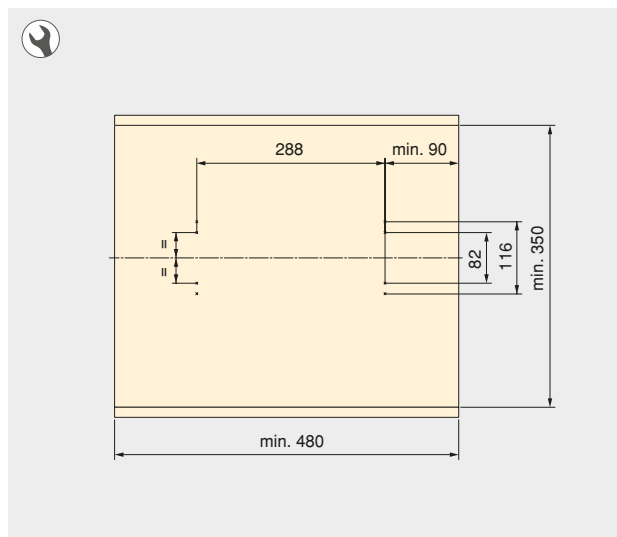
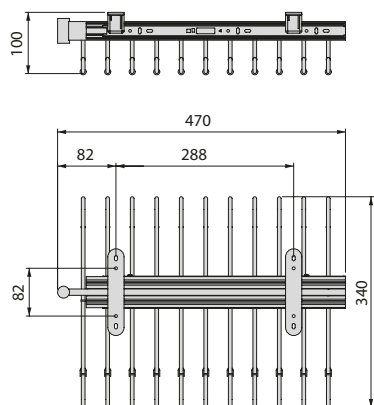

SELF ACCESSORIES // AKCESORIA SELF

Self pull-out lateral trouser rack

Wysuwany boczny wieszak na spodnie Self

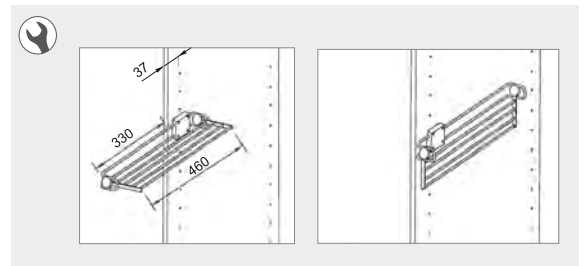
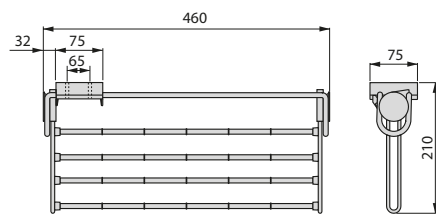

Finishing Wykończenie	Format Format	Cod.
Silver painted Malowane aluminium	1 Ut/Szt	6211125

Plastic, Steel
Plastik, Stal

Self pull-out lateral tie

Wysuwany boczny wieszak na krawaty Self

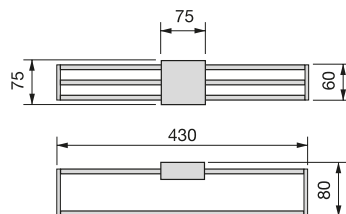

Finishing Wykończenie	Format Format	Cod.
Silver painted Malowane aluminium	10 Ut/Szt	6211025

Plastic, Steel
Plastik, Stal



SELF ACCESSORIES // AKCESORIA SELF

Wardrobe side mounting Self trouser rack

Wieszak na spodnie Self do montażu bocznego w szafie

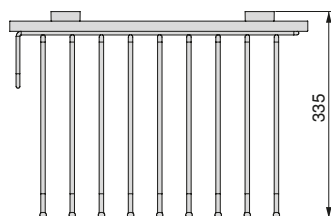
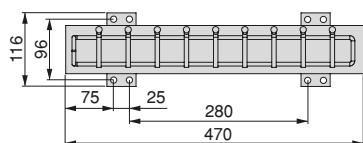

Hand Uchwyty	Finishing Wykończenie	Format Format	Cod.
Left hand Lewa ręka	Chrome plated Chromowane	1 Ut/Szt	7018111
Right hand Prawa ręka	Chrome plated Chromowane	1 Ut/Szt	7018211

Aluminium, Plastic, Steel
Aluminium, Plastik, Stal

Self Pullout double trouser rack for wardrobes.

Zdejmowany podwójny wieszak na spodnie Self do szafy.

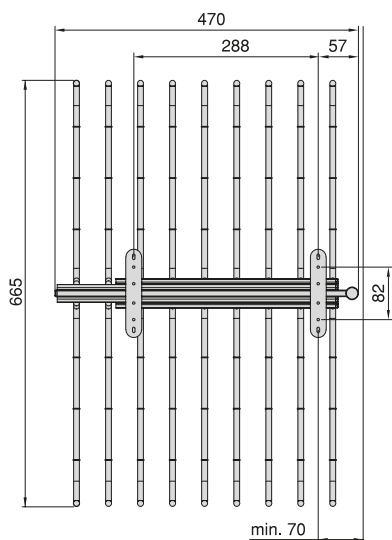
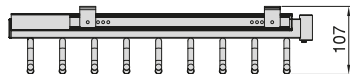

Finishing Wykończenie	Format Format	Cod.
Chrome plated Chromowane	1 Ut/Szt	7017911

Plastic, Steel
Plastik, Stal

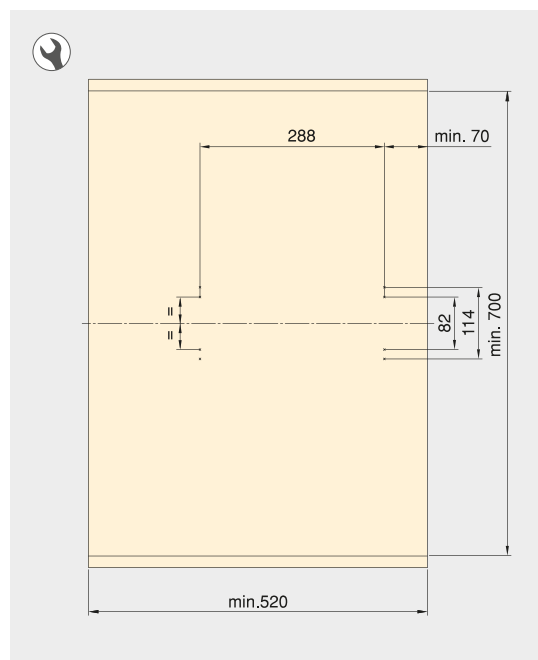

SELF ACCESSORIES // AKCESORIA SELF

Self Pull-out wardrobe rail

Wysuwany wieszak Self do szafy



A	B	L	Finishing Wykończenie	Format Format	Cod.
335	302	300	Silver painted Malowane aluminium	10 Ut/Szt	6210925
385	352	350	Silver painted Malowane aluminium	10 Ut/Szt	6210825
435	402	400	Silver painted Malowane aluminium	10 Ut/Szt	6210725
485	452	450	Silver painted Malowane aluminium	10 Ut/Szt	6210625

Plastic, Steel
Plastik, Stal

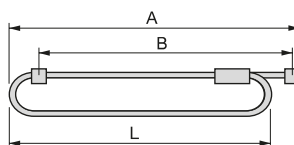

Self shoe rack for inside wardrobe

Stojak na buty Self do wnętrza szafy



Finishing Wykończenie	Format Format	Cod.
Silver painted Malowane aluminium	1 Ut/Szt	6211225

Plastic, Steel
Plastik, Stal

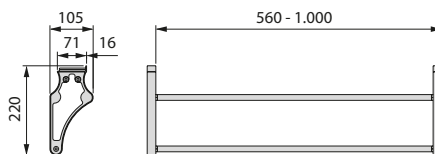

SELF ACCESSORIES // AKCESORIA SELF

Self extractable hanger for very deep wardrobes

Wysuwany wieszak do szafy Self

Longitude Długość	Finishing Wykończenie	Format Format	Cod.
800	Black painted Malowane na czarno	1 Ut/Szt	7005714
800	Silver painted Malowane aluminium	1 Ut/Szt	7005725

Plastic, Steel
Plastik, Stal

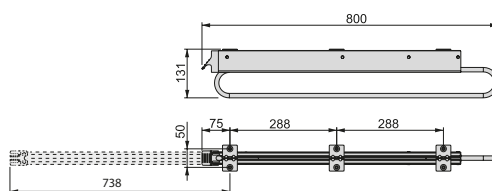

ZERO



MODULAR STRUCTURE ZERO IN KIT FORM // STRUKTURA MODUŁOWA ZERO W KOMPLECIE

Zero modular structure kit with tools and profiles to be assembled in L-shape

Zestaw struktury modułowej Zero z okuciami i profilami do montażu w kształcie litery L



Description Opis	Finishing Wykończenie	Format Format	Cod.
2 Profiles 2 Profil	Textured black painted Teksturowana czern	1 KIT/Zestaw	7022054
3 Profiles 3 Profil	Textured black painted Teksturowana czern	1 KIT/Zestaw	7022154

Aluminium, Plastic, Zamak
Aluminium, Plastik, Znak

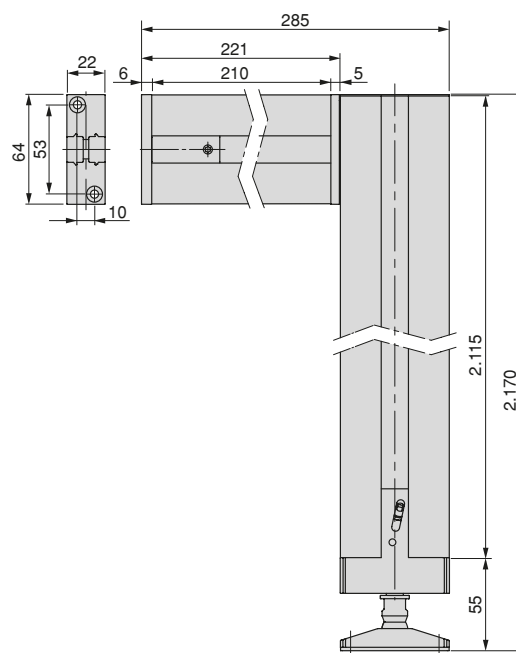
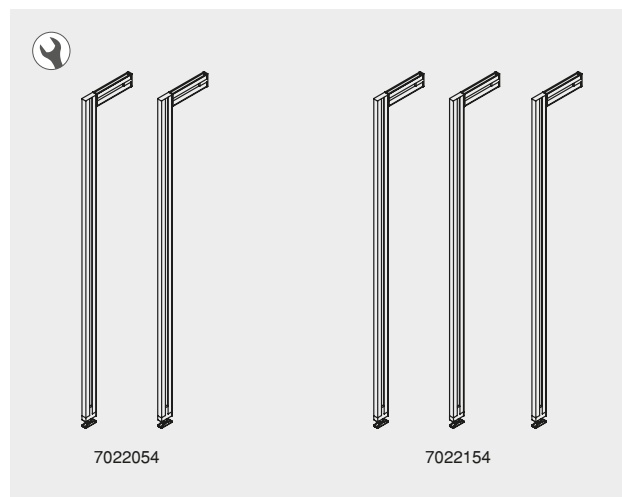

Zero support kit for wooden shelves and module

Zestaw wsporników Zero do półek drewnianych i modułów

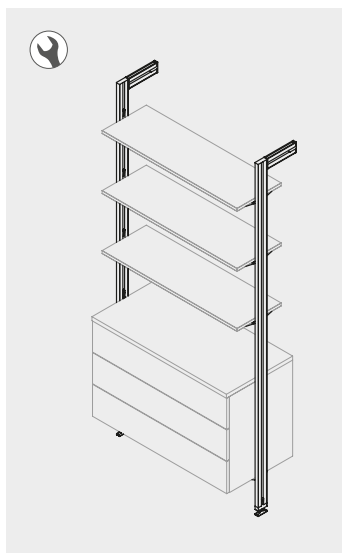

Finishing Wykończenie	Format Format	Cod.
Textured black painted Teksturowana czern	1 KIT/Zestaw	7022254

Plastic, Zamak
Plastik, Znak



MODULAR STRUCTURE ZERO IN KIT FORM // STRUKTURA MODUŁOWA ZERO W KOMPLECIE

Zero Kit supports for wooden shelves and hanging rail

Zestaw wsporników Zero do półek z drewna i drążka do zawieszania



Finishing Wykończenie	Format Format	Cod.
Textured black painted Teksturowana czerń	1 KIT/Zestaw	7022354
Aluminium, Plastic, Zamak Aluminium, Plastik, Znal		

Zero support kit for wooden and module shelves and hanging rail

Zestaw wsporników Zero do półek z drewna, modułu i drążka na wieszaki



Finishing Wykończenie	Format Format	Cod.
Textured black painted Teksturowana czerń	1 KIT/Zestaw	7022454
Aluminium, Plastic, Zamak Aluminium, Plastik, Znal		

Zero support set for wooden shelf

Zestaw wsporników Zero do półki drewnianej



Finishing Wykończenie	Format Format	Cod.
Textured black painted Teksturowana czerń	1 KIT/Zestaw	7021354
Zamak Znal		

Zero support set for glass shelf

Zestaw wsporników Zero do szklanej półki



Finishing Wykończenie	Format Format	Cod.
Textured black painted Teksturowana czerń	1 KIT/Zestaw	7021454
Zamak Znal		



MODULAR STRUCTURE ZERO // STRUKTURA MODUŁOWA ZERO

Profile for Zero modular structures

Profil do tworzenia struktur modułowych Zero



Longitude Długość	Finishing Wykończenie	Format Format	Cod.
2,35 m	Textured black painted Teksturowana czerni	8 Ut/Szt	7020154
2,9 m	Textured black painted Teksturowana czerni	8 Ut/Szt	7020254

Aluminium
Aluminium

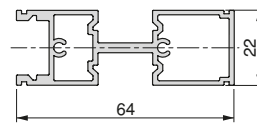

Can be cut to size.

Możliwość personalizacji.

tool assembly set for assembling Zero profiles in L-shape

Zestaw okuć do montażu profili Zero w kształcie litery L



Finishing Wykończenie	Format Format	Cod.
Textured black painted Teksturowana czerni	1 KIT/ Zestaw	7021054

Plastic, Zamak
Plastik, Znal

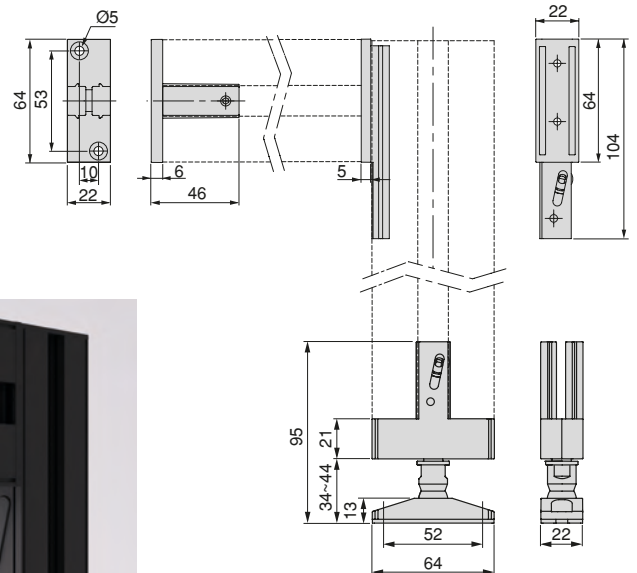



MODULAR STRUCTURE ZERO // STRUKTURA MODUŁOWA ZERO

Cover cap for Zero profile

Zaślepka do profilu Zero



N° pieces Liczba ele- mentów	Finishing Wykończenie	Format Format	Cod.
20 units 20 jednostki	Black plastic Czarny plastik	1 LOT/Partia	7022517

Plastic
Plastik

piece to affix the Zero profile to the wall

Element do montażu ściennego profilu Zero



x8

Finishing Wykończenie	Format Format	Cod.
Textured black painted Teksturowana czerń	1 KIT/ Zestaw	7021754

Zamak
Znal

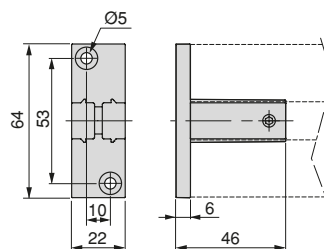

Joint between Zero profiles

Element do łączenia profili Zero



x8

Finishing Wykończenie	Format Format	Cod.
Textured black painted Teksturowana czerń	1 KIT/ Zestaw	7021254

Zamak
Znal

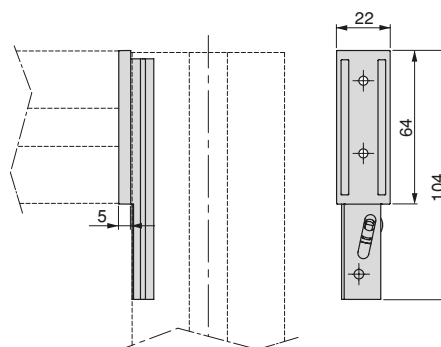



100 HOURS IN BOULDER
THE 100 HOURS IN BOULDER
THE 100 HOURS IN BOULDER
THE 100 HOURS IN BOULDER
THE 100 HOURS IN BOULDER
THE 100 HOURS IN BOULDER
THE 100 HOURS IN BOULDER
THE 100 HOURS IN BOULDER
THE 100 HOURS IN BOULDER
THE 100 HOURS IN BOULDER

SUPERNATURAL - SAM & BIN



VOICE
ZODIAC SIGNS
Night



THE 100 HOURS IN BOULDER
THE 100 HOURS IN BOULDER
THE 100 HOURS IN BOULDER
THE 100 HOURS IN BOULDER
THE 100 HOURS IN BOULDER
THE 100 HOURS IN BOULDER
THE 100 HOURS IN BOULDER
THE 100 HOURS IN BOULDER
THE 100 HOURS IN BOULDER
THE 100 HOURS IN BOULDER



DREAM OF TIME
DREAM OF TIME
DREAM OF TIME
DREAM OF TIME
DREAM OF TIME
DREAM OF TIME
DREAM OF TIME
DREAM OF TIME
DREAM OF TIME
DREAM OF TIME

THE 100 HOURS IN BOULDER
THE 100 HOURS IN BOULDER
THE 100 HOURS IN BOULDER
THE 100 HOURS IN BOULDER
THE 100 HOURS IN BOULDER
THE 100 HOURS IN BOULDER
THE 100 HOURS IN BOULDER
THE 100 HOURS IN BOULDER
THE 100 HOURS IN BOULDER
THE 100 HOURS IN BOULDER

THE 100 HOURS IN BOULDER
THE 100 HOURS IN BOULDER
THE 100 HOURS IN BOULDER
THE 100 HOURS IN BOULDER
THE 100 HOURS IN BOULDER
THE 100 HOURS IN BOULDER
THE 100 HOURS IN BOULDER
THE 100 HOURS IN BOULDER
THE 100 HOURS IN BOULDER
THE 100 HOURS IN BOULDER

THE 100 HOURS IN BOULDER
THE 100 HOURS IN BOULDER
THE 100 HOURS IN BOULDER
THE 100 HOURS IN BOULDER
THE 100 HOURS IN BOULDER
THE 100 HOURS IN BOULDER
THE 100 HOURS IN BOULDER
THE 100 HOURS IN BOULDER
THE 100 HOURS IN BOULDER
THE 100 HOURS IN BOULDER



THE 100 HOURS IN BOULDER
THE 100 HOURS IN BOULDER
THE 100 HOURS IN BOULDER
THE 100 HOURS IN BOULDER
THE 100 HOURS IN BOULDER
THE 100 HOURS IN BOULDER
THE 100 HOURS IN BOULDER
THE 100 HOURS IN BOULDER
THE 100 HOURS IN BOULDER
THE 100 HOURS IN BOULDER



CARS
TIM WALKER STORY TELLER
THE PAVLOV BOOK
FOREVER

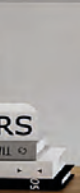

AESTHETE
Interior design
Mountain Guide



SUPERNATURAL - SAM & BIN



AESTHETE
FASHION



MODULAR STRUCTURE ZERO // STRUKTURA MODUŁOWA ZERO

Leveller to affix profile to floor/ceiling for Zero profile
 Poziomica do mocowania do podłogi / sufitu do profilu Zero



x16



Finishing Wykończenie	Format Format	Cod.
Textured black painted Teksturowana czern	1 KIT/ Zestaw	7021154

Plastic, Zamak
Plastik, Znal

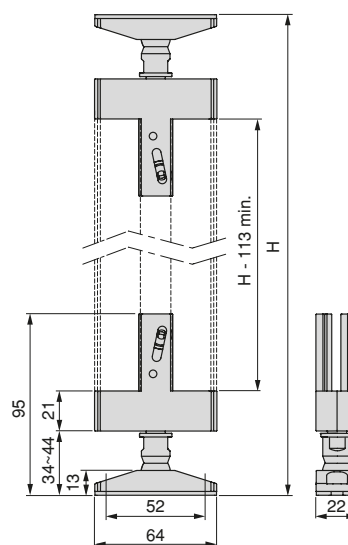

Zero support set for wooden shelf
 Zestaw wsporników Zero do półki drewnianej



x5



Finishing Wykończenie	Format Format	Cod.
Textured black painted Teksturowana czern	1 KIT/ Zestaw	7021354

Zamak
Znal

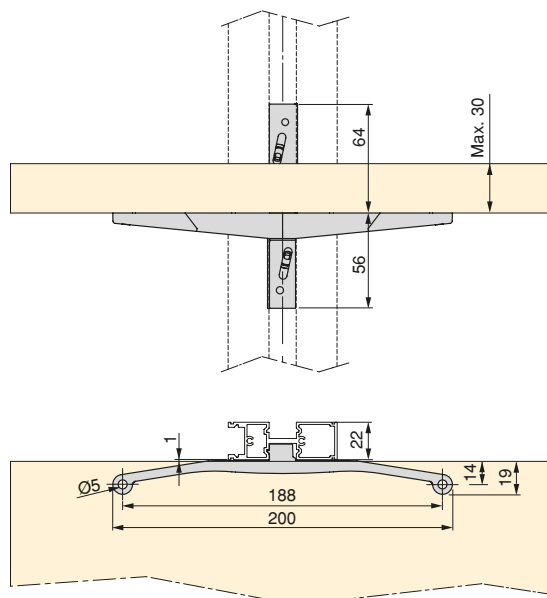



MODULAR STRUCTURE ZERO // STRUKTURA MODUŁOWA ZERO

Zero support set for glass shelf

Zestaw wsporników Zero do szklanej półki



Finishing Wykończenie	Format Format	Cod.
Textured black painted Teksturowana czerń	1 KIT/ Zestaw	7021454

Zamak
Znal

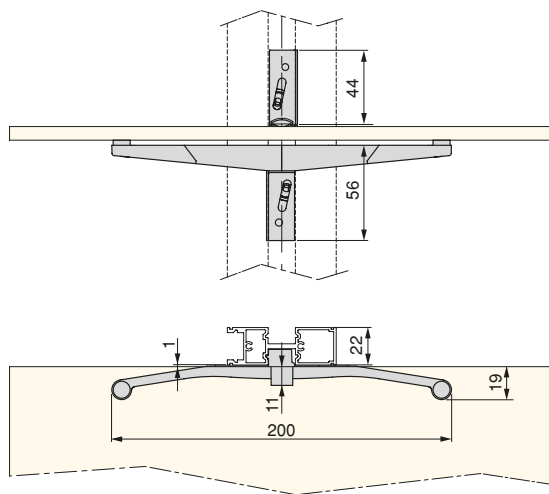

Zero support kit for module

Zestaw wsporników Zero do modułu



Finishing Wykończenie	Format Format	Cod.
Textured black painted Teksturowana czerń	1 KIT/ Zestaw	7021554

Zamak
Znal

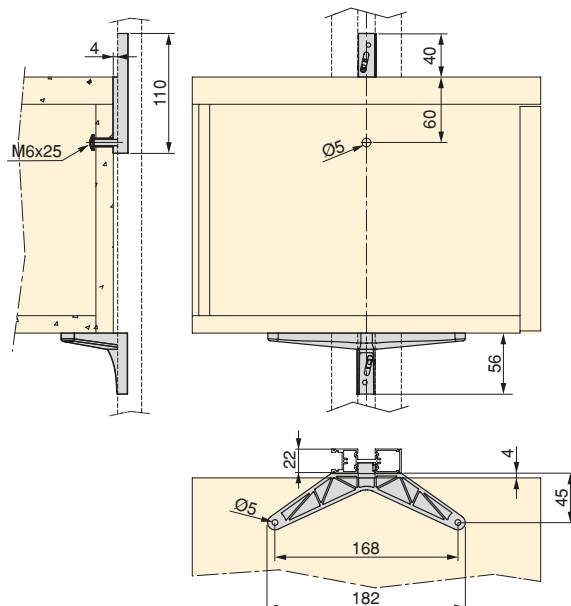



MODULAR STRUCTURE ZERO // STRUKTURA MODUŁOWA ZERO

Zero support kit for hanging rail

Zestaw wsporników Zero do drążka na wieszaki

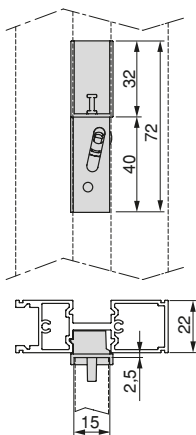

Finishing Wykończenie	Format Format	Cod.
Textured black painted Teksturowana czerń	1 KIT/ Zestaw	7021654

Plastic, Zamak
Plastik, Znal

Luxe rectangular rail for Zero structure

Drążek prostokątny Luxe do struktury Zero

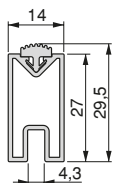

Longitude Długość	Finishing Wykończenie	Format Format	Cod.
1 m	Textured black painted Teksturowana czerń	10 Ut/Szt	7102154
2,35 m	Textured black painted Teksturowana czerń	10 Ut/Szt	7102254

Aluminium
Aluminium



Can be cut to size.
Możliwość personalizacji.



LADER



LADER BOOKCASES // SZAFKA LADER

Structure for Lader bookcases

Stelaż do szafki Lader



Height Wysokość	Finishing Wykończenie	Format Format	Cod.
830	Black painted Malowane na czarno	1 Ut/Szt	4450014
1150	Black painted Malowane na czarno	1 Ut/Szt	4450114
1790	Black painted Malowane na czarno	1 Ut/Szt	4450314

Steel
Stal

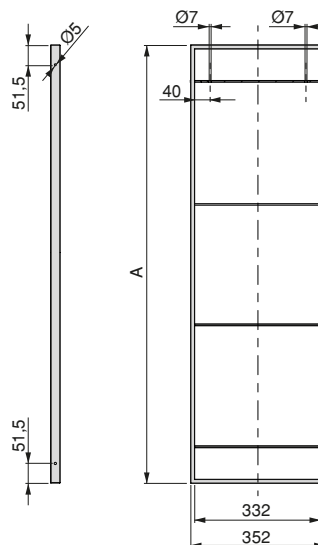

Lader Bookcases with structure and shelves

Szafka Lader ze stelażem i półkami



Width Szerokość	Height Wysokość	Finishing Wykończenie	Format Format	Cod.
690	1150	Black painted Malowane na czarno	1 Ut/Szt	4450214

Steel, Wood
Drewno, Stal

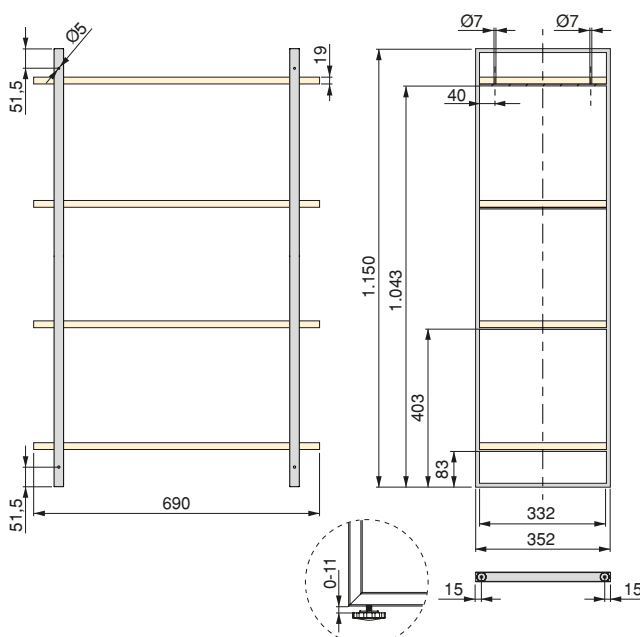

JAGMET



JAGMET STRUCTURE // SYSTEM JAGMET

Jagmet Single Slot Wall Mounting Profiles, 50mm pitch

Profile do montażu ściennego Jagmet z pojedynczym rowkiem o rozstawie 50 mm



Longitude Długość	Finishing Wykończenie	Format Format	Cod.
1 m	White painted Malowane na biało	10 Ut/Szt	7918012
2,0 m	White painted Malowane na biało	10 Ut/Szt	7916512
2,5 m	White painted Malowane na biało	10 Ut/Szt	7916612

Steel Stal

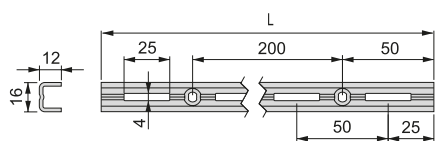

Single Slot Jagmet Shelf Brackets with 50mm Pitch

Wsporniki do półek Jagmet pojedyncze szczelinowe o rozstawie 50 mm

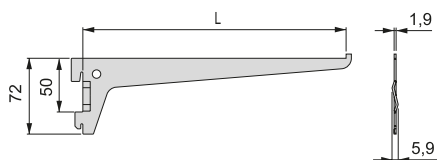

Load Ładunek	Longitude Długość	Finishing Wykończenie	Format Format	Cod.
40	200	White painted Malowane na biało	20 Ut/Szt	7917012
32	250	White painted Malowane na biało	20 Ut/Szt	7915612
26	300	White painted Malowane na biało	20 Ut/Szt	7915712
23	350	White painted Malowane na biało	20 Ut/Szt	7915812
20	400	White painted Malowane na biało	20 Ut/Szt	7915912

Steel Stal





JAGMET STRUCTURE // SYSTEM JAGMET

Jagmet Double Groove Wall Fixing Profiles with 32mm pitch

Profile do montażu ściennego Jagmet z podwójnym rowkiem o rozstawie 32 mm

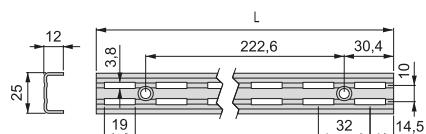

Longitude Długość	Finishing Wykończenie	Format Format	Cod.
0,951 m	White painted Malowane na biało	10 Ut/Szt	7916712
1,396 m	White painted Malowane na biało	10 Ut/Szt	7916812
2,064 m	White painted Malowane na biało	10 Ut/Szt	7916912
2,229 m	White painted Malowane na biało	10 Ut/Szt	7917912

Steel
Stal

Jagmet Double Slot Wall Mounting Profiles, 32mm pitch

Wsporniki do półek Jagmet z podwójnym rowkiem o rozstawie 32 mm

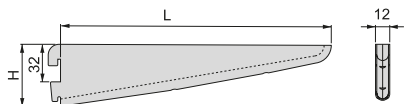

Height Wysokość	Load Ładunek	Longitude Długość	Finishing Wykończenie	Format Format	Cod.
47	44	170	White painted Malowane na biało	20 Ut/Szt	7916012
49	34	220	White painted Malowane na biało	20 Ut/Szt	7916112
52	27	270	White painted Malowane na biało	20 Ut/Szt	7916212
58	23	320	White painted Malowane na biało	20 Ut/Szt	7918112
64	20	370	White painted Malowane na biało	20 Ut/Szt	7916312
80	16	470	White painted Malowane na biało	20 Ut/Szt	7918212

Steel
Stal

Wire shelves and Jagmet supports

Półki druciane i wsporniki Jagmet

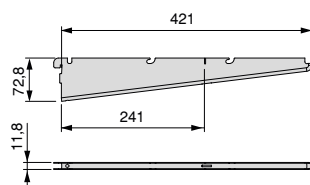

Finishing Wykończenie	Format Format	Cod.
White painted Malowane na biało	1 KIT/Zestaw	7027612

Steel
Stal

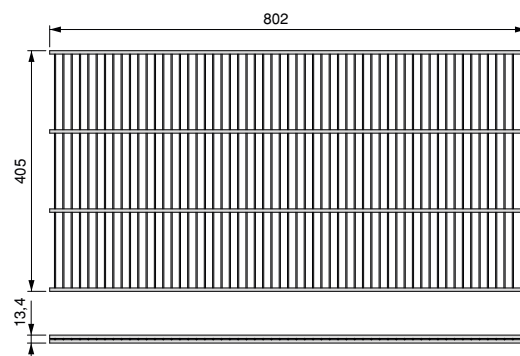



JAGMET STRUCTURE // SYSTEM JAGMET

Wall fastening rails and Jagmet shelf supports

Profile mocowane do ściany i wsporniki do półek Jagmet



C	Longitude Długość	Finishing Wykończenie	Format Format	Cod.
157	230	White painted Malowane na biało	1 KIT/Zestaw	7026612
207	280	White painted Malowane na biało	1 KIT/Zestaw	7026712
307	380	White painted Malowane na biało	1 KIT/Zestaw	7026812

Steel
Stal

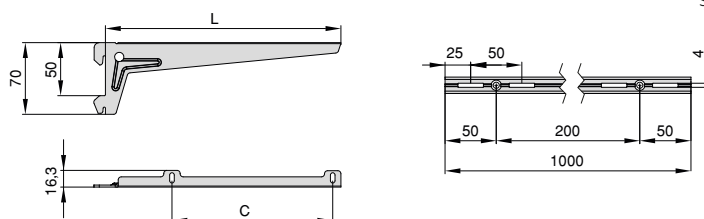

Wall fastening plates and Jagmet shelf supports

Płyty mocowane do ściany i wsporniki do półek Jagmet



C	Longitude Długość	Finishing Wykończenie	Format Format	Cod.
157	230	White painted Malowane na biało	1 KIT/Zestaw	7026912
207	280	White painted Malowane na biało	1 KIT/Zestaw	7027012
307	380	White painted Malowane na biało	1 KIT/Zestaw	7027112

Steel
Stal

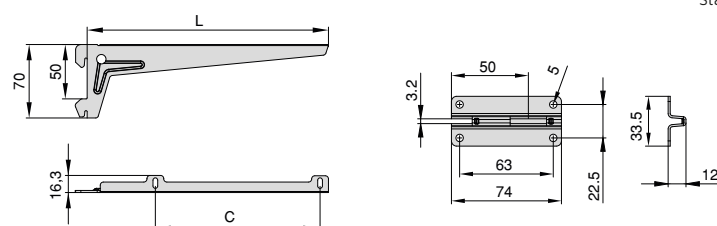

Wire baskets and Jagmet supports

Kosze druciane i wsporniki Jagmet



Finishing Wykończenie	Format Format	Cod.
White painted Malowane na biało	1 KIT/Zestaw	7027412

Steel
Stal

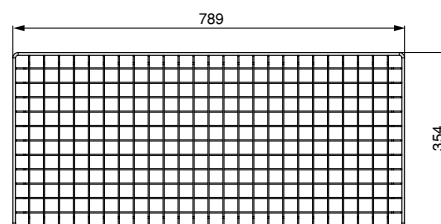



JAGMET STRUCTURE // SYSTEM JAGMET

Jagmet wardrobe bars

Drażki do szafy Jagmet

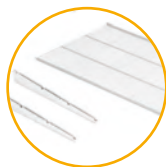

Finishing Wykończenie	Format Format	Cod.
White painted Malowane na biało	1 KIT/Zestaw	7027712

Steel
Stal

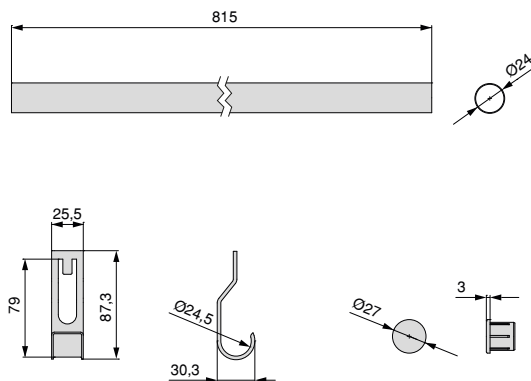

Folding coat hanger bars for a Jagmet wardrobe

Wieszaki składane Jagmet na wieszaki odzieżowe do szafy



Finishing Wykończenie	Format Format	Cod.
White painted Malowane na biało	1 KIT/Zestaw	7027812

Steel
Stal

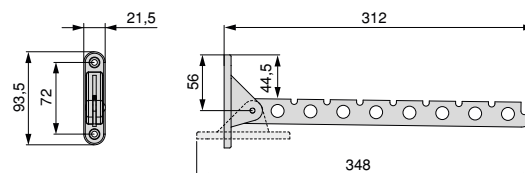

PERFILES PERFIS



ADIGE HANDLE PROFILES // PROFILE UCHWYTOWE ADIGE

Adige vertical profile for wardrobe

Profil pionowy Adige do szaf

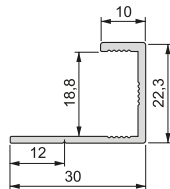

Longitude Długość	Finishing Wykończenie	Format Format	Cod.
2,8 m	Matt anodized Anodyzowany mat	10 Ut/Szt	7013462

Aluminium
Aluminium

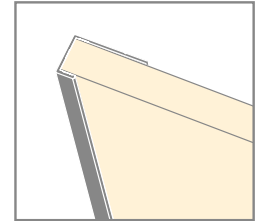

Adige handle profile for wardrobe

Profil uchwytowy Adige do szaf

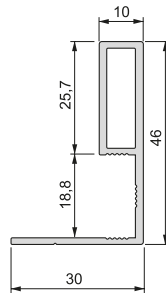

Longitude Długość	Finishing Wykończenie	Format Format	Cod.
2,8 m	Matt anodized Anodyzowany mat	10 Ut/Szt	7013262

Aluminium
Aluminium

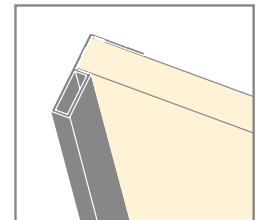

Adige handle cover profile for wardrobe

Profil osłony uchwytu Adige do szaf

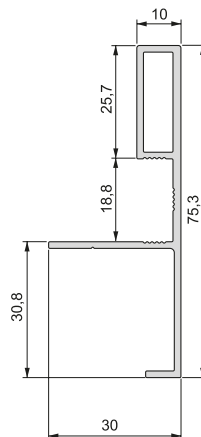

Longitude Długość	Finishing Wykończenie	Format Format	Cod.
2,8 m	Matt anodized Anodyzowany mat	10 Ut/Szt	7013362

Aluminium
Aluminium

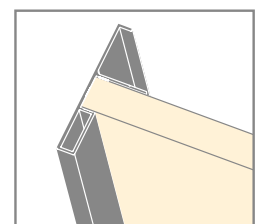

To calculate the measure to cut the board reduce 4 mm to the width of door.

Aby obliczyć wymiary płyty do wycięcia należy odjąć 4 mm od szerokości drzwi.



Can be cut to size.
Możliwość personalizacji.

FREE FACE HANDLE PROFILES // PROFILE UCHWYTOWE FREE FACE

Free Face vertical profile for wardrobe

Profil pionowy Free Face do szaf

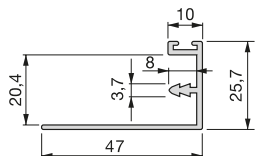
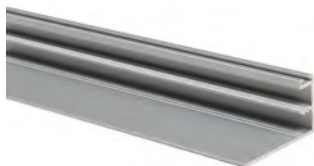

Free Face handle profile for wardrobe

Profil uchwytowy Free Face do szaf

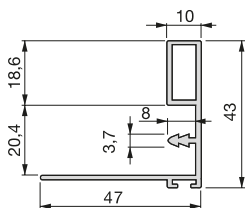
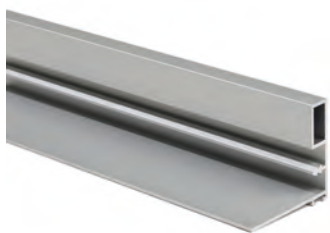

Free Face handle cover profile for wardrobe

Profil osłony uchwytu Free Face do szaf

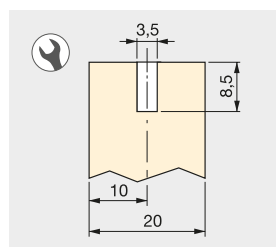
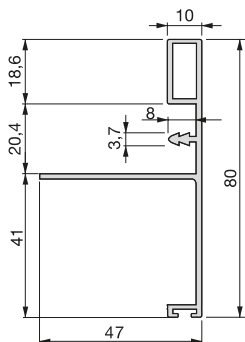
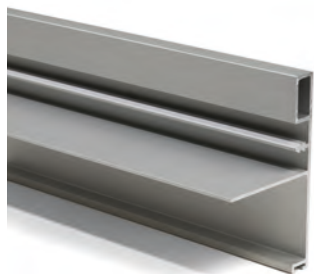

To calculate the measure to cut the board reduce 4 mm to the width of door. Allows the use of dustguards profiles Cod. 9045121, 9034221 and 9034121.

Aby obliczyć wymiary płyty do wycięcia należy odjąć 4 mm od szerokości drzwi. Umożliwia stosowanie profili osłon przeciwkurzowych kody 9045121, 9034221 i 9034121.



Can be cut to size.
Możliwość personalizacji.

Longitude Długość	Finishing Wykończenie	Format Format	Cod.
2,35 m	Matt anodized Anodyzowany mat	10 Ut/Szt	7025562
2,9 m	Matt anodized Anodyzowany mat	10 Ut/Szt	5872762

Aluminium
Aluminium

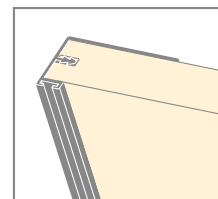

Longitude Długość	Finishing Wykończenie	Format Format	Cod.
2,35 m	Matt anodized Anodyzowany mat	10 Ut/Szt	7025362
2,9 m	Matt anodized Anodyzowany mat	10 Ut/Szt	5872862

Aluminium
Aluminium

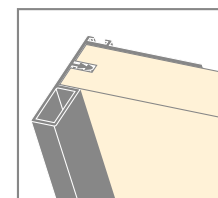

Longitude Długość	Finishing Wykończenie	Format Format	Cod.
2,35 m	Matt anodized Anodyzowany mat	5 Ut/Szt	7025462
2,9 m	Matt anodized Anodyzowany mat	5 Ut/Szt	5872962

Aluminium
Aluminium

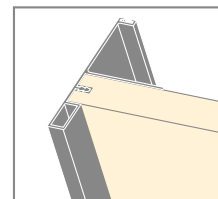

FREE RAPID HANDLE PROFILES // PROFIL UCHWYTOWE FREE RAPID

Free Rapid vertical profile for wardrobe

Profil pionowy Free Rapid do szaf

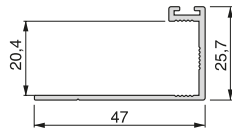

Free Rapid handle profile for wardrobe

Profil uchwytowy Free Rapid do szaf

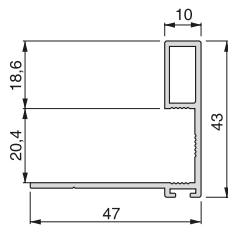

Free Rapid handle cover profile

Profil osłony uchwytu Free Rapid do szaf

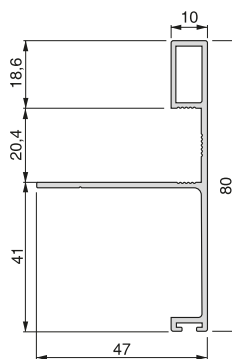

To calculate the measure to cut the board reduce 4 mm to the width of door. Allows the use of dustguards profiles Cod. 9045121, 9034221 and 9034121.

Aby obliczyć wymiary płyty do wycięcia należy odjąć 4 mm od szerokości drzwi. Umożliwia stosowanie profili osłon przeciwkurzowych kody 9045121, 9034221 i 9034121.



Can be cut to size.
Możliwość personalizacji.

Longitude Długość	Finishing Wykończenie	Format Format	Cod.
2,35 m	Matt anodized Anodyzowany mat		10 Ut/Szt 7026062
2,7 m	Matt anodized Anodyzowany mat		10 Ut/Szt 7018562

Aluminium
Aluminium

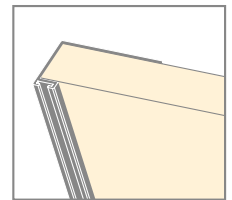

Longitude Długość	Finishing Wykończenie	Format Format	Cod.
2,35 m	Matt anodized Anodyzowany mat		10 Ut/Szt 7025862
2,7 m	Matt anodized Anodyzowany mat		10 Ut/Szt 7018362

Aluminium
Aluminium

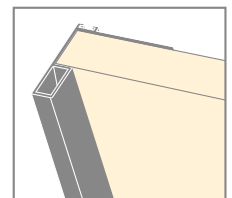

Longitude Długość	Finishing Wykończenie	Format Format	Cod.
2,35 m	Matt anodized Anodyzowany mat		5 Ut/Szt 7025962
2,7 m	Matt anodized Anodyzowany mat		5 Ut/Szt 7018462

Aluminium
Aluminium

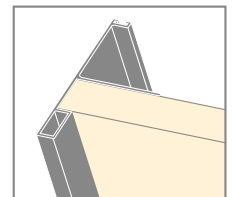

STYL HANDLE PROFILES // PROFILE UCHWYTOWE STYL

Styl 1 handle profile for wardrobe

Profil uchwytyowy Styl do szaf

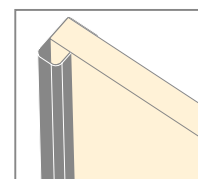
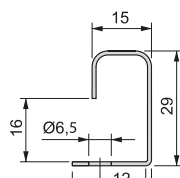

Longitude Długość	Finishing Wykończenie	Format Format	Cod.
2,355 m	Silver painted Malowane aluminium	10 Ut/Szt	7016325

Steel
Stal

To calculate the measure to cut the board reduce 2 mm to the width of door.

Aby obliczyć wymiary płyty do wycięcia należy odjąć 2 mm od szerokości drzwi.

U Styl 1 handle profiles for wardrobe

Perfil endireitador U Styl do szaf

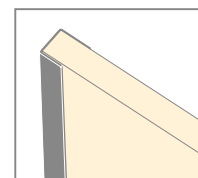
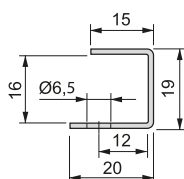

Longitude Długość	Finishing Wykończenie	Format Format	Cod.
2,355 m	Silver painted Malowane aluminium	10 Ut/Szt	7016125

Steel
Stal

To calculate the measure to cut the board reduce 2 mm to the width of door.

Aby obliczyć wymiary płyty do wycięcia należy odjąć 2 mm od szerokości drzwi.



Can be cut to size.
Możliwość personalizacji.

RHODES HANDLE PROFILES // PROFILE UCHWYTOWE RHODES

Rhodes furniture handle

Uchwyty meblowe Rhodes

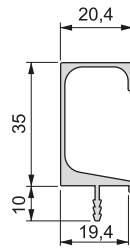
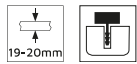

Longitude Długość	Finishing Wykończenie	Format Format	Cod.
2,9 m	Matt anodized Anodyzowany mat	10 Ut/Szt	9296662

Aluminium
Aluminium

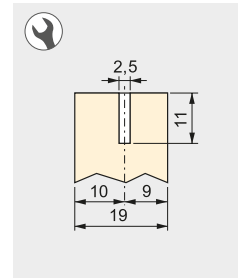

Sparta profile furniture handle

Uchwyty meblowe Perfil puxador Sparta

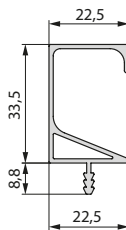
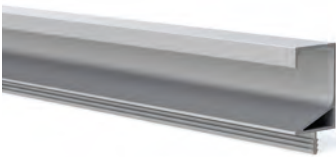

Longitude Długość	Finishing Wykończenie	Format Format	Cod.
2,35 m	Matt anodized Anodyzowany mat	10 Ut/Szt	7026562

Aluminium
Aluminium

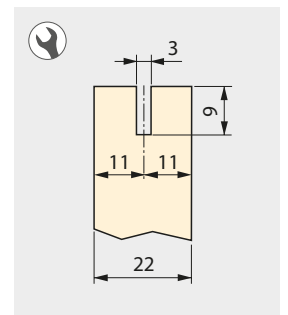

Sparta covers for cabinet handles

Ośłony Sparta do uchwytów do szaf

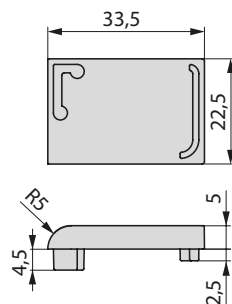
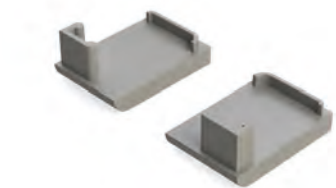

Finishing Wykończenie	Format Format	Cod.
Silver painted Malowane aluminium	10 Ut/Szt	9291125

Plastic
Plastik

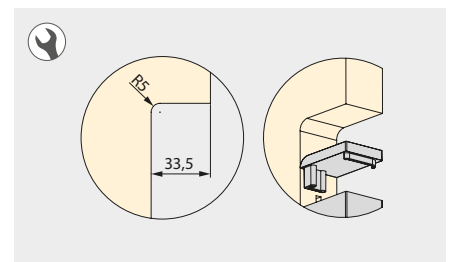

Can be cut to size.
Możliwość personalizacji.

DUST EXCLUDER STRIPS // TAŚMY PRZECIWPYŁOWE

Profiles without adhesive dust cover for sliding door

Listwa przeciwkurzowa bez warstwy klejącej szczotka przeciwkurzowa do drzwi przesuwnych

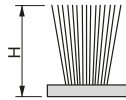

Height Wysokość	Longitude Długość	Finishing Wykończenie	Format Format	Cod.
5	375 m	Grey plastic Szary plastik	1 Ut/Szt	9045121
7	225 m	Grey plastic Szary plastik	1 Ut/Szt	9034221
9	175 m	Grey plastic Szary plastik	1 Ut/Szt	9034121

Plastic Plastik

Profiles with adhesive dust cover for sliding door

Listwa przeciwkurzowa z warstwą klejącą szczotka przeciwkurzowa do drzwi przesuwnych

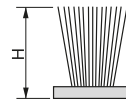

Height Wysokość	Longitude Długość	Finishing Wykończenie	Format Format	Cod.
7	400 m	Grey plastic Szary plastik	1 Ut/Szt	9129921
9	300 m	Grey plastic Szary plastik	1 Ut/Szt	9034321
17	125 m	Grey plastic Szary plastik	1 Ut/Szt	9054021

Plastic Plastik

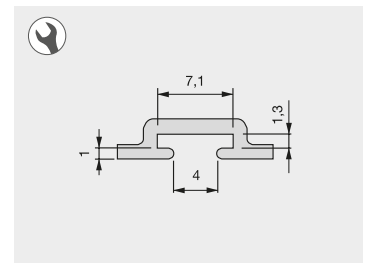

self-adhesive dust excluder for doors and windows

Samoprzylepna osłona przeciwpyłowa do drzwi i okien

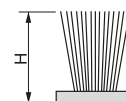

Height Wysokość	Finishing Wykończenie	Format Format	Cod.
7	Grey plastic Szary plastik	10 m/m	7089321
9	Grey plastic Szary plastik	10 m/m	7089421
17	Grey plastic Szary plastik	10 m/m	7089521

Plastic Plastik

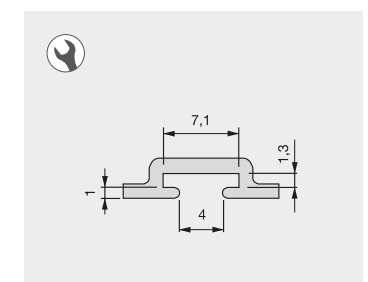



DOOR TRUSS // NAPINACZE DO DRZWI

Even truss for wardrobe door

Okucie wyrównujące drzwi Even do drzwi szafy



L	M	Finishing Wykończenie	Format Format	Cod.
1.970	1.920	Matt anodized Anodyzowany mat	 25 Ut/Szt	7089662
2.290	2.240	Matt anodized Anodyzowany mat	 25 Ut/Szt	7089762

Aluminium, Plastic, Steel
Aluminium, Plastik, Stal

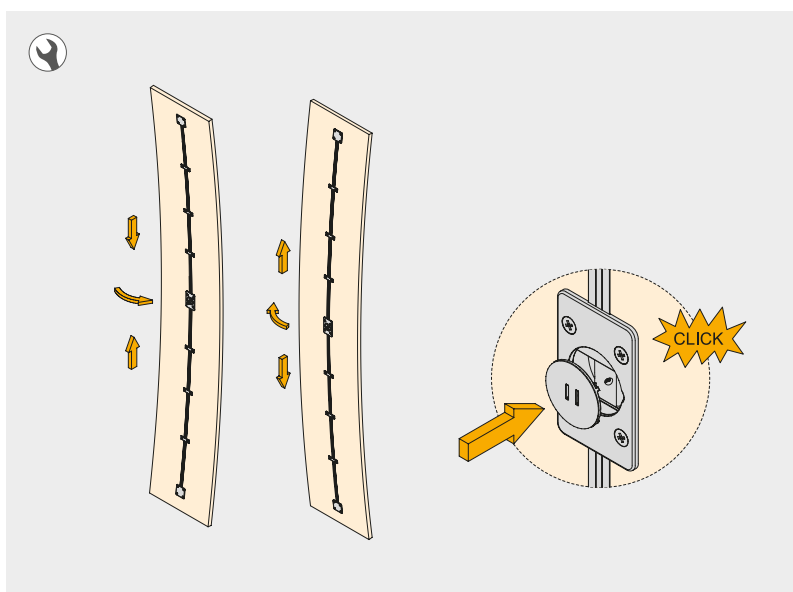
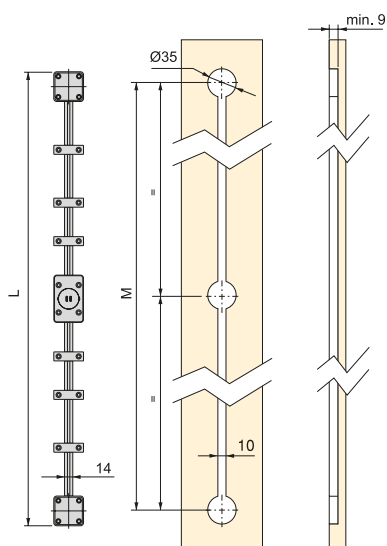

For the assembly, we recommend to use 2 truss per door.

Przy montażu zalecamy stosowanie 2 kratownic na drzwi.

EDGING PROFILES FACE // PROFILE KRAWĘDZIOWE FACE

Profile for edges Face 3

Profil narożny Face 3

A	B	Board thickness Grubość płyty	Longitude Długość	Finishing Wykończenie	Format Format	Cod.
19,4	9,5	19	2,35 m	Matt anodized Anodizowany mat	 25 Ut/Szt	6224462

Aluminium
Aluminium

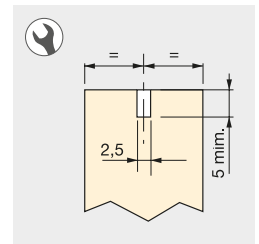
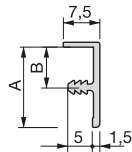

Profile for edges Face 4

Profil narożny Face 4

Board thickness Grubość płyty	Longitude Długość	Finishing Wykończenie	Format Format	Cod.
19	2,35 m	Matt anodized Anodizowany mat	 25 Ut/Szt	7025662

Aluminium
Aluminium

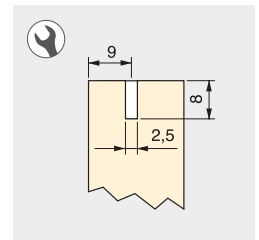
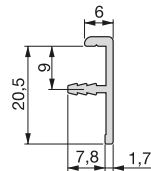

Profile for edges Face T

Profil narożny Face T

Longitude Długość	Finishing Wykończenie	Format Format	Cod.
2,35 m	Matt anodized Anodizowany mat	 25 Ut/Szt	6057762

Aluminium
Aluminium

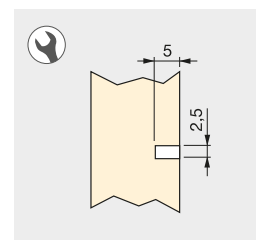

Can be cut to size.
Możliwość personalizacji.

EDGING PROFILES FACE // PROFILE KRAWĘDZIOWE FACE

Profile for edges Wind

Profil narożny Wind

Longitude Długość	Finishing Wykończenie	Format Format	Cod.
2,35 m	Natural aluminium Naturalne aluminium	 20 Ut/Szt	6301761

Aluminium
Aluminium

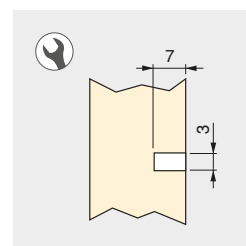
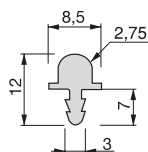

Can be cut to size.
Możliwość personalizacji.



PUERTAS DE ALUMINIO

PORTAS DE ALUMÍNIO



PLUS PROFILES // PROFILE PLUS

Profile for cabinets Plus 4

Profil do szafy Plus 7

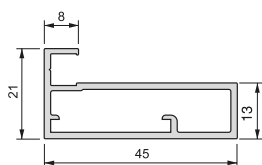

Longitude Długość	Finishing Wykończenie	Format Format	Cod.
2,35 m	Matt anodized Anodizowany mat	8 Ut/Szt	6304362

Aluminium
Aluminium

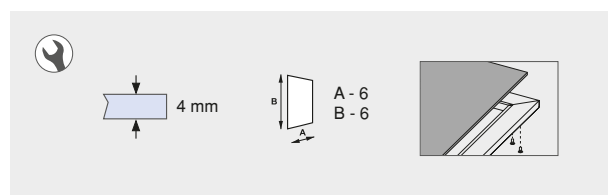

Can be cut to size.
Możliwość personalizacji.

Profile for cabinets Plus 7

Profil do szafy Face 2

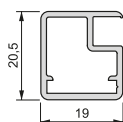

Longitude Długość	Finishing Wykończenie	Format Format	Cod.
2,35 m	Matt anodized Anodizowany mat	20 Ut/Szt	7025262

Aluminium
Aluminium

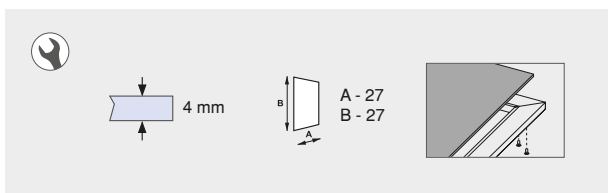



Can be cut to size.
Możliwość personalizacji.

PLUS PROFILES // PROFIL PLUS

Profile for cabinets Plus 11

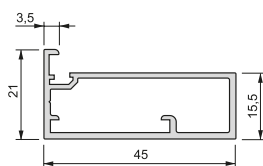
Profil do szafy Plus 11



Longitude Długość	Finishing Wykończenie	Format Format	Cod.
2,35 m	Matt anodized Anodizowany mat	 8 Ut/Szt	6300762

Aluminium
Aluminium

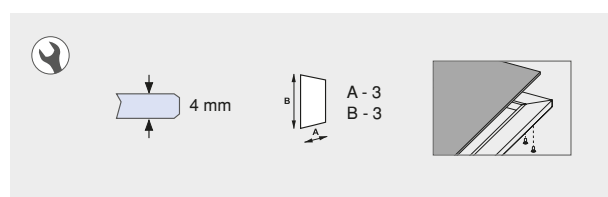

Can be cut to size.
Możliwość personalizacji.

Profile for cabinets Plus 14 - 14+4 upper and lower profile

Profil do szafy Plus 4

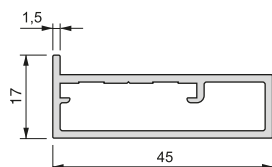

Longitude Długość	Finishing Wykończenie	Format Format	Cod.
2,35 m	Matt anodized Anodizowany mat	 8 Ut/Szt	6304462

Aluminium
Aluminium

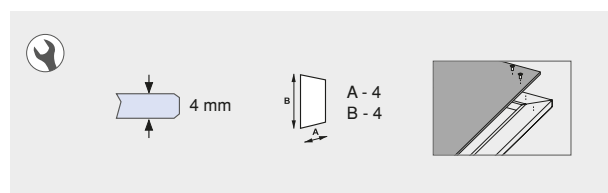

Can be cut to size.
Możliwość personalizacji.

PLUS PROFILES // PROFIL PLUS

Profile for cabinets Plus 15

Profil do szafy Plus 15

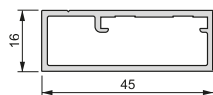

Can be cut to size.
Możliwość personalizacji.

Profile for cabinets Plus 18

Profil do szafy Plus 18

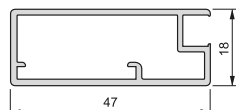

Can be cut to size.
Możliwość personalizacji.

Longitude Długość	Finishing Wykończenie	Format Format	Cod.
2,35 m	Matt anodized Anodyzowany mat	 8 Ut/Szt	6304562

Aluminium
Aluminium

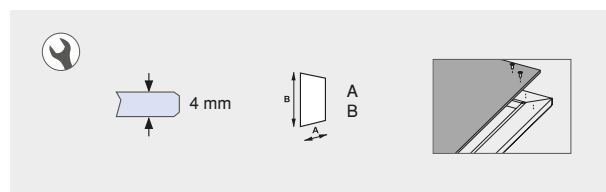

Longitude Długość	Finishing Wykończenie	Format Format	Cod.
2,35 m	Matt anodized Anodyzowany mat	 8 Ut/Szt	7026462

Aluminium
Aluminium

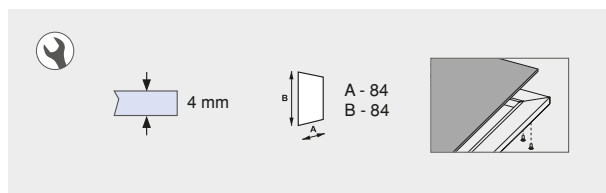

ACCESSORIES FOR PLUS PROFILES // AKCESORIA DO PROFILI PLUS

Fittings for one crosspiece Plus

Okucia do jednej poprzeczki Plus



Finishing Wykończenie	Format Format	Cod.
Transparent / not defined Przezroczyste / nieokreślone	 20 Ut/Szt	6251820

Steel, Zamak
Stal, Znak

CALCULATING SIZE OF GLASS FOR DOORS WITH CROSSPIECE

$$\text{Height} = (H - B - (nT \times 3)) / (nT + 1)$$

$$\text{Width} = (A - B - (nV \times 3)) / (nV + 1)$$

H = Height.
nT = Number of horizontal crosspieces.

A = Width.
nV = Number of vertical crosspieces.

B = 6 mm (Profiles Plus 4).
B = 27 mm (Profiles Plus 7).
B = 3 mm (Profiles Plus 11).

OBLICZANIE WIELKOŚCI SZB DO DRZWI Z POPRZECZKĄ

$$\text{Wysokość} = (H - B - (nT \times 3)) / (nT + 1)$$

$$\text{Szerokość} = (A - B - (nV \times 3)) / (nV + 1)$$

H = Wysokość.
nT = Liczba poziomych poprzeczek.

A = Szerokość.
nV = Liczba pionowych poprzeczek.

B = 6 mm (Profile Plus 4).
B = 27 mm (Profile Plus 7).
B = 3 mm (Profile Plus 11).

Gasket for Plus 4 - 7 - 18 profiles

Gałka do profilu Plus 4 - 7 - 18



Description Opis	Longitude Długość	Finishing Wykończenie	Format Format	Cod.
Gasket for 4 mm glass Uszczelka do szyby 4 mm	2,35 m	Grey plastic Szary plastik	 20 Ut/Szt	7921021

Plastic
Plastik

Gasket for Plus 11 profiles

Gałka do profilu Plus 11



Description Opis	Longitude Długość	Finishing Wykończenie	Format Format	Cod.
Gasket for 4 mm glass Uszczelka do szyby 4 mm	2,35 m	Transparent / not defined Przezroczyste / nieokreślone	 20 Ut/Szt	7922020

Plastic
Plastik

Adhesive tape for glass Plus 14 - 15

Taśma klejąca do szkła Plus 14-15



Description Opis	Longitude Długość	Finishing Wykończenie	Format Format	Cod.
Adhesive tape for glass Taśma samoprzylepna do szkła	33 m	White plastic Biały plastik	 1 Ut/Szt	6000215

Plastic
Plastik



ACCESSORIES FOR PLUS PROFILES // AKCESORIA DO PROFILI PLUS

Spacer for handles of doors with glass

Uszczelka gumowa do szyby do drzwi ze szkłem

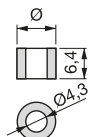

Diametre Średnica	Finishing Wykończenie	Format Format	Cod.
7,9	Transparent / not defined Przezroczyste / nieokreślone	 20 Ut/Szt	6227320

Plastic
Plastik

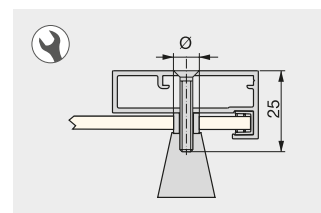

Corners for Plus 7 profiles

Wsporniki do profilu Plus 7



x4

x8

Finishing Wykończenie	Format Format	Cod.
Transparent / not defined Przezroczyste / nieokreślone	 10 Ut/Szt	9984720

Steel
Stal

Corners for Plus 4 - 11 - 14 - 15 - 18 profiles

Wsporniki do profilu Plus 4 - 11 - 14 - 15 - 18



x4

x8

Finishing Wykończenie	Format Format	Cod.
Transparent / not defined Przezroczyste / nieokreślone	 10 Ut/Szt	9985520

Steel
Stal



ACCESSORIES FOR PLUS PROFILES // AKCESORIA DO PROFILI PLUS

Tulip1 adhesive furniture handle

Uchwyt samoprzylepny do mebli Tulip1

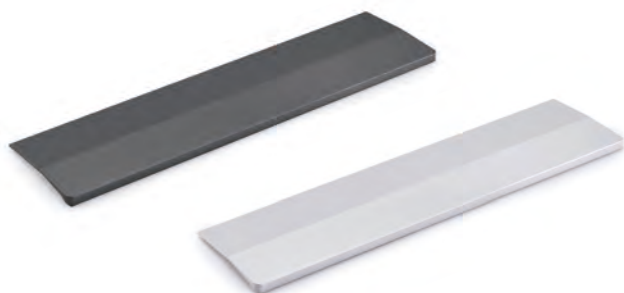

L	Finishing Wykończenie	Format Format	Cod.
62	Matt anodized Anodyzowany mat	20 Ut/Szt	6920262
94	Matt anodized Anodyzowany mat	20 Ut/Szt	6920362
126	Matt anodized Anodyzowany mat	20 Ut/Szt	6920462
158	Matt anodized Anodyzowany mat	20 Ut/Szt	6920562

Aluminium
Aluminium

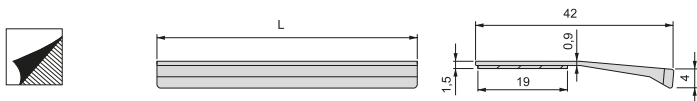

Tulip2 adhesive furniture handle

Uchwyt samoprzylepny do mebli Tulip2



L	Finishing Wykończenie	Format Format	Cod.
158	Bright anodized Anodowane polyskowe	20 Ut/Szt	6920960
62	Matt anodized Anodyzowany mat	20 Ut/Szt	6920662
94	Matt anodized Anodyzowany mat	20 Ut/Szt	6920762
126	Matt anodized Anodyzowany mat	20 Ut/Szt	6920862
158	Matt anodized Anodyzowany mat	20 Ut/Szt	6920962



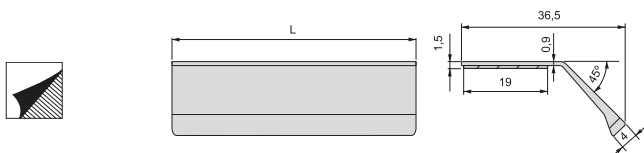



Aluminium
Aluminium



Free profiles

Profile Free



Description Opis	Longitude Długość	Finishing Wykończenie	Format Format	Cod.
Handle Uchwyt	2,6 m	Matt anodized Anodyzowany mat	 12 Ut/Szt	6909462
Handle with wing Uchwyt ze skrzydełkiem	2,6 m	Matt anodized Anodyzowany mat	 6 Ut/Szt	6909562
Vertical Pionowy	2,6 m	Matt anodized Anodyzowany mat	 12 Ut/Szt	6909362
Upper / Bottom Górny / dolny	2,35 m	Matt anodized Anodyzowany mat	 6 Ut/Szt	7025062
Middle profile Profil środkowy	2,35 m	Matt anodized Anodyzowany mat	 12 Ut/Szt	7025162
Middle hidden profile Profil środkowy	2,35 m	Matt anodized Anodyzowany mat	 12 Ut/Szt	6304262
Gasket for 4 mm glass Uszczelka do szyby 4 mm	2,35 m	Grey plastic Szary plastik	 20 Ut/Szt	7920021

Aluminium, Plastic
Aluminium, Plastik



Can be cut to size.
Możliwość personalizacji.



How to calculate the profiles:
Vertical = H
Horizontal = A - 20 mm

Jak obliczyć profile:
Pionowy = H
Poziomy = A - 20mm

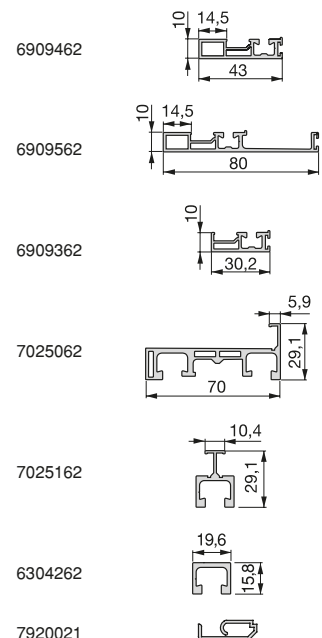

FREE DOORS // DRZWI FREE

Fittings for one door Free

Okucia do jednych drzwi Free



Description Opis	Set Zestaw	Finishing Wykończenie	Format Format	Cod.
Space + Space +	1 Cross-piece 1 Profil	Transparent / not defined Przezroczyste / nieokreślone	<input type="checkbox"/>	1 Ut/Szt 7016820
Space + Space +	2 Cross-pieces 2 Profil	Transparent / not defined Przezroczyste / nieokreślone	<input type="checkbox"/>	1 Ut/Szt 7016920
Space + Space +	3 Cross-pieces 3 Profil	Transparent / not defined Przezroczyste / nieokreślone	<input type="checkbox"/>	1 Ut/Szt 7017020

Aluminium, Steel, Zamak
Aluminium, Stal, Znak

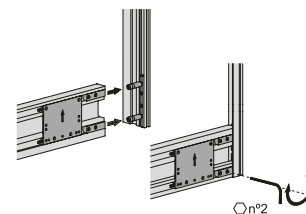
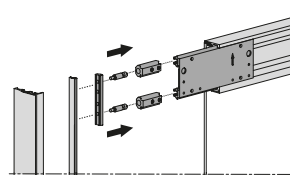
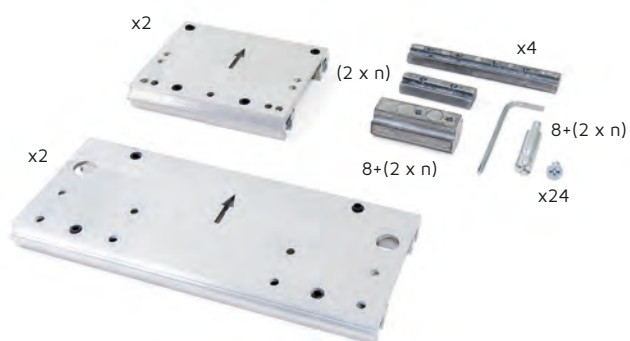

T Link for Free wardrobe doors

Złącze T do poprzeczek Free do drzwi szafy Free

Finishing Wykończenie	Format Format	Cod.
Transparent / not defined Przezroczyste / nieokreślone	<input type="checkbox"/>	1 Ut/Szt 6100620

Various
Różne

