

LIGHTING

OŚWIETLENIE



Lighting

LED Strips

- 551 Lynx Premium (12V DC)
- 554 Lynx Premium RGB (12V DC)
- 556 Lynx Basic (12V DC)
- 558 Lynx connectors (12V DC)
- 560 Lynx Premium (24V DC)
- 561 Lynx Premium COB (24V DC)
- 562 Neonlynx (24 V DC)
- 563 Lynx connectors (24V DC)
- 565 Sensors
- 566 Profiles Lynx W
- 570 Profiles Lynx

LED lights

- 579 Lights
- 582 Spots
- 588 Illuminated hanging bars
- 590 Oświetlenie łazienkowe
- 594 Illuminated mirrors
- 598 Battery operated

Drivers and detectors

- 601 Drivers
- 604 Detectors
- 612 LED light controllers
- 614 Cables
- 615 Switches

Office

- 617 Chargers
- 628 Connectors
- 630 Cable profile
- 638 Accessories
- 641 TV supports
- 644 Extending keyboard shelf runner

Oświetlenie

Taśmy LED

- 551 Lynx Premium (12V DC)
- 554 Lynx Premium RGB (12V DC)
- 556 Lynx Basic (12V DC)
- 558 Złącza Lynx (12V DC)
- 560 Lynx Premium (24V DC)
- 561 Lynx Premium COB (24V DC)
- 562 Neonlynx (24 V DC)
- 563 Złącza Lynx (24V DC)
- 565 Czujniki
- 566 Profile Lynx W
- 570 Profile Lynx

Światła LED

- 579 Kinkiety
- 582 Punkt
- 588 Podświetlane drążki na wieszaki
- 590 Bathroom lights
- 594 Podświetlane lustra
- 598 Z baterią

Konwertory i czujniki

- 601 Konwertory
- 604 Czujniki
- 612 Sterowniki oświetlenia LED
- 614 Kable
- 615 Przełączniki, wyłączniki

Cabinet

- 617 Ładowarki
- 628 Złącza
- 630 Przepusty kablowe
- 638 Akcesoria
- 641 Wsporniki na telewizory
- 644 Prowadnice do pówek na klawiaturę

LED STRIPS TAŚMY LED



LYNX PREMIUM (12V DC) // LYNX PREMIUM (12V DC)

LED Strip Lynx Premium 4,8W/m IP20 (12V DC)

Taśma LED Lynx Premium 9,6 W/m IP20 (24V DC)

L	Efficiency Wydajność	Lumen	Power Moc	Colour temperature Temperatura koloru	LEDs	Finishing Wykończenie	Format Format	Cod.
5 m	85 lm / W	410 lm / m	4,8 W / m	Cold white 6.000 K Zimna biel 6.000 K	60 LEDs / m	Transparent / not defined Przezroczyste / nieokreślone		2 Ut/Szt 5200920
10 m	85 lm / W	410 lm / m	4,8 W / m	Natural white 4.000 K Naturalna biel 4.000 K	60 LEDs / m	Transparent / not defined Przezroczyste / nieokreślone		1 Ut/Szt 5201020
5 m	85 lm / W	410 lm / m	4,8 W / m	Warm white 3.000 K Ciepła biel 3.000 K	60 LEDs / m	Transparent / not defined Przezroczyste / nieokreślone		2 Ut/Szt 5201120

Plastic
Plastik

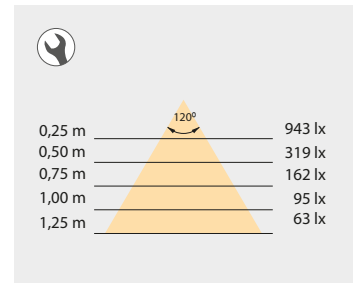
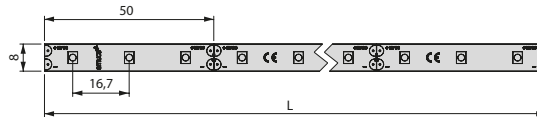

IP20			CRI ≥80	LED SMD 3528	DOUBLE PCB	3M [®]	120°	max. 10 m	dimnable 0-100%	3 LEDs
	SENSOR 12V DC	UK CA ICE					12V DC			

LED Strip Lynx Premium 4,8W/m IP65 (12V DC)

Taśma LED Neonlynx 7,6W/m IP65 (24V DC)

L	Efficiency Wydajność	Lumen	Power Moc	Colour temperature Temperatura koloru	LEDs	Finishing Wykończenie	Format Format	Cod.
10 m	85 lm / W	410 lm / m	4,8 W / m	Natural white 4.000 K Naturalna biel 4.000 K	60 LEDs / m	Transparent / not defined Przezroczyste / nieokreślone		1 Ut/Szt 5210520

Plastic
Plastik

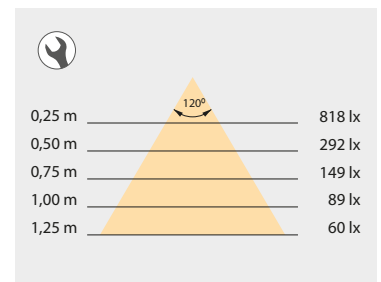
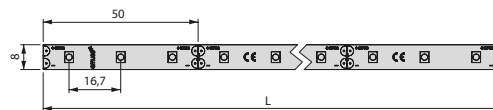

IP65	PUR		CRI ≥80	LED SMD 3528	DOUBLE PCB	3M [®]	120°	max. 10 m	dimnable 0-100%	3 LEDs
	SENSOR 12V DC	UK CA ICE					12V DC			

LYNX PREMIUM (12V DC) // LYNX PREMIUM (12V DC)

LED Strip Lynx Premium 9,6W/m IP20 (12V DC)

Taśma LED Style 10

L	Efficiency Wydajność	Lumen	Power Moc	Colour temperature Temperatura koloru	LEDs	Finishing Wykończenie	Format Format	Cod.
5 m	84 lm / W	805 lm / m	9,6 W / m	Cold white 6.000 K Zimna biel 6.000 K	120 LEDs / m	Transparent / not defined Przezroczyste / nieokreślone	2 Ut/Szt	5201420
10 m	84 lm / W	805 lm / m	9,6 W / m	Natural white 4.000 K Naturalna biel 4.000 K	120 LEDs / m	Transparent / not defined Przezroczyste / nieokreślone	1 Ut/Szt	5201520
5 m	84 lm / W	805 lm / m	9,6 W / m	Warm white 3.000 K Ciepła biel 3.000 K	120 LEDs / m	Transparent / not defined Przezroczyste / nieokreślone	2 Ut/Szt	5201620

Plastic
Plastik

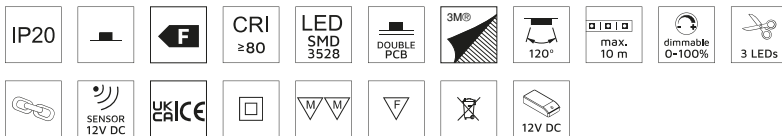
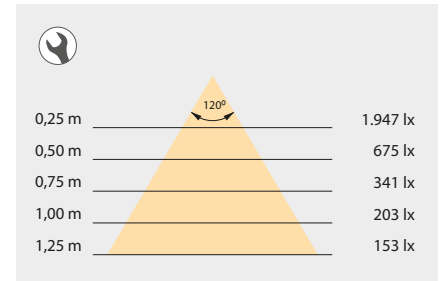
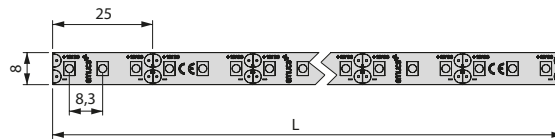

LED Strip Lynx Premium 9,6W/m IP65 (12V DC)

Taśma LED Wave 10

L	Efficiency Wydajność	Lumen	Power Moc	Colour temperature Temperatura koloru	LEDs	Finishing Wykończenie	Format Format	Cod.
10 m	84 lm / W	805 lm / m	9,6 W / m	Natural white 4.000 K Naturalna biel 4.000 K	120 LEDs / m	Transparent / not defined Przezroczyste / nieokreślone	1 Ut/Szt	5201720
5 m	84 lm / W	805 lm / m	9,6 W / m	Warm white 3.000 K Ciepła biel 3.000 K	120 LEDs / m	Transparent / not defined Przezroczyste / nieokreślone	2 Ut/Szt	5201820

Plastic
Plastik

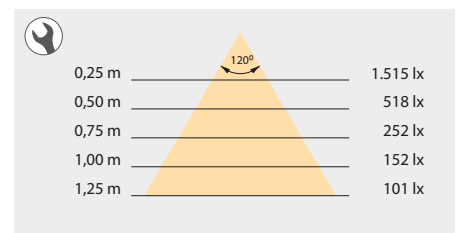
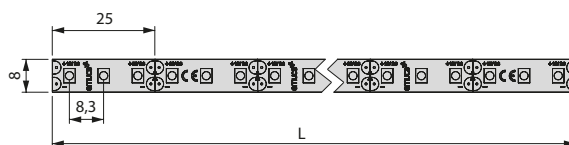

LYNX PREMIUM (12V DC) // LYNX PREMIUM (12V DC)

LED Strip Lynx Premium 14,4W/m IP20 (12V DC)

Taśma LED Lynx Premium 14,4W/m IP20

L	Efficiency Wydajność	Lumen	Power Moc	Colour temperature Temperatura koloru	LEDs	Finishing Wykończenie	Format Format	Cod.
5 m	83 lm / W	1.200 lm / m	14,4 W / m	Cold white 6.000 K Zimna biel 6.000 K	60 LEDs / m	Transparent / not defined Przezroczyste / nieokreślone		2 Ut/Szt 5201920
5 m	83 lm / W	1.200 lm / m	14,4 W / m	Natural white 4.000 K Naturalna biel 4.000 K	60 LEDs / m	Transparent / not defined Przezroczyste / nieokreślone		2 Ut/Szt 5202020
5 m	83 lm / W	1.200 lm / m	14,4 W / m	Warm white 3.000 K Ciepła biel 3.000 K	60 LEDs / m	Transparent / not defined Przezroczyste / nieokreślone		2 Ut/Szt 5202120

Plastic
Plastik

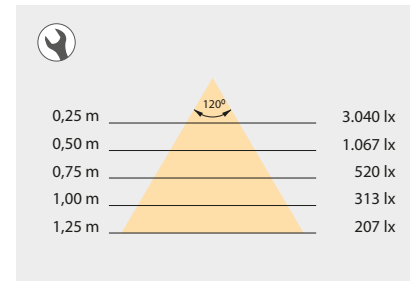
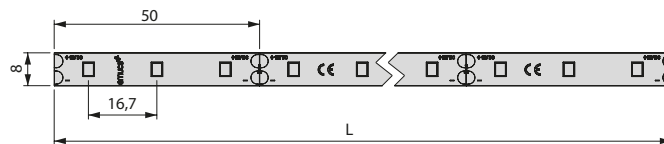

LED Strip Lynx Premium 14,4W/m IP65 (12V DC)

Taśma LED Lynx Premium 14,4W/m IP65

L	Efficiency Wydajność	Lumen	Power Moc	Colour temperature Temperatura koloru	LEDs	Finishing Wykończenie	Format Format	Cod.
5 m	83 lm / W	1.200 lm / m	14,4 W / m	Natural white 4.000 K Naturalna biel 4.000 K	60 LEDs / m	Transparent / not defined Przezroczyste / nieokreślone		2 Ut/Szt 5202220

Plastic
Plastik

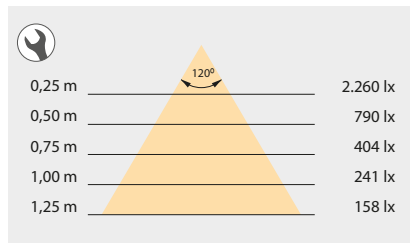
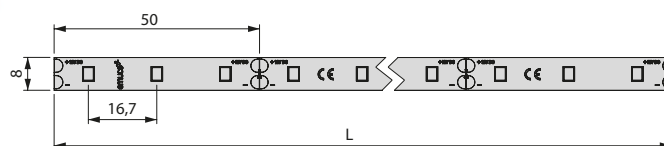

LYNX PREMIUM RGB (12V DC) // LYNX PREMIUM RGB (12V DC)

Octans RGB LED Strip Kit with remote control and WIFI control via APP (12V DC)

Zestaw Octans RGB LED z pilotem zdalnego sterowania i sterowany poprzez aplikację na WIFI (12V DC)

L	Power Moc	Colour temperature Temperatura koloru	Finishing Wykończenie	Format Format	Cod.
5 m	2,4 W / m	RGB RGB	Transparent / not defined Przezroczyste / nieokreślone	<input type="checkbox"/>	1 Ut/Szt 5209120

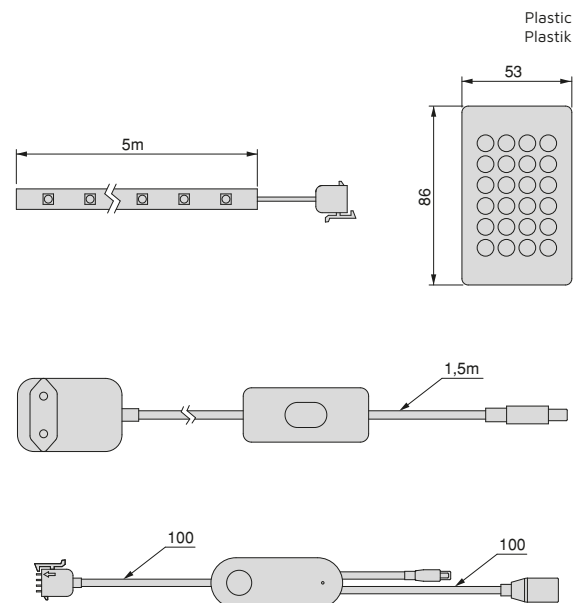

Plastic
Plastik



Octans RGB LED Strip Kit with remote control and WIFI control via APP (5V DC)

Zestaw Octans RGB LED z pilotem zdalnego sterowania i sterowany poprzez aplikację na WIFI (12V DC)

L	Power Moc	Colour temperature Temperatura koloru	Finishing Wykończenie	Format Format	Cod.
4 x 0,5 m	4,8 W / m	RGB RGB	Transparent / not defined Przezroczyste / nieokreślone	<input type="checkbox"/>	1 Ut/Szt 5209220

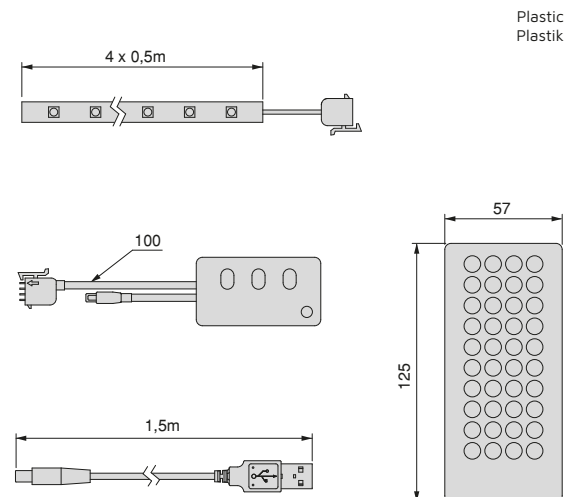

Plastic
Plastik

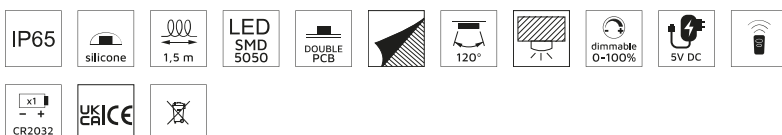

LYNX PREMIUM RGB (12V DC) // LYNX PREMIUM RGB (12V DC)

LED Strip Lynx Premium RGB 14,4W/m IP65 (12V DC)

Taśma LED Lynx Premium RGB 14,4W/m IP65 (12V DC)

L	Efficiency Wydajność	Lumen	Power Moc	Colour temperature Temperatura koloru	LEDs	Finishing Wykończenie	Format Format	Cod.
5 m	67 lm / W	960 lm / m	14,4 W / m	RGB RGB	60 LEDs / m	Transparent / not defined Przezroczyste / nieokreślone		1 Ut/Szt 5200020

Plastic
Plastik

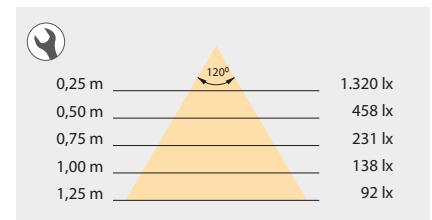
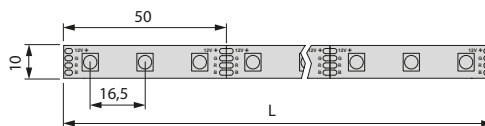

-
-
-
-
-
-
-
-
-
-
-
-
-
-
-
-
-

Cable RGB for LED strip (12V DC)

Kabel RGB (12V DC)

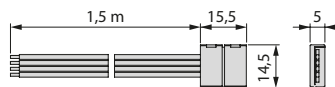

Finishing Wykończenie	Format Format	Cod.
Transparent / not defined Przezroczyste / nieokreślone		5 Ut/Szt 5020620

Plastic
Plastik

Connector RGB for RGB LED strips (12V DC)

Złącze RGB (12V DC)

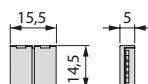



Finishing Wykończenie	Format Format	Cod.
Transparent / not defined Przezroczyste / nieokreślone		5 Ut/Szt 5020920

Plastic
Plastik

LYNX BASIC (12V DC) // LYNX BASIC (12V DC)









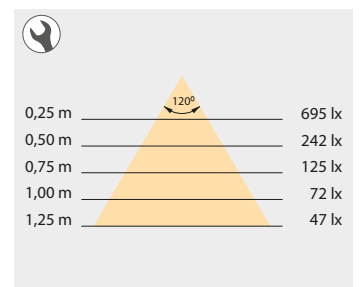
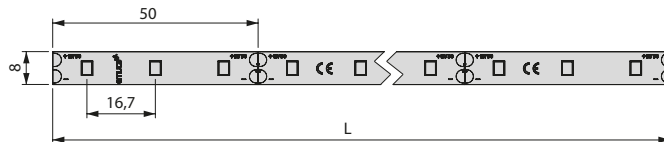



LED Strip Lynx Basic 4,8W/m IP20 (12V DC)

Taśma LED Lynx Basic 4,8W/m IP20

L	Efficiency Wydajność	Lumen	Power Moc	Colour temperature Temperatura koloru	LEDs	Finishing Wykończenie	Format Format	Cod.
5 m	69 lm / W	330 lm / m	4,8 W / m	Cold white 6.000 K Zimna biel 6.000 K	60 LEDs / m	Transparent / not defined Przezroczyste / nieokreślone		2 Ut/Szt 5200120
5 m	69 lm / W	330 lm / m	4,8 W / m	Warm white 3.000 K Ciepła biel 3.000 K	60 LEDs / m	Transparent / not defined Przezroczyste / nieokreślone		2 Ut/Szt 5200220



Plastic
Plastik



IP20   LED SMD 2835    3 LEDs         12V DC









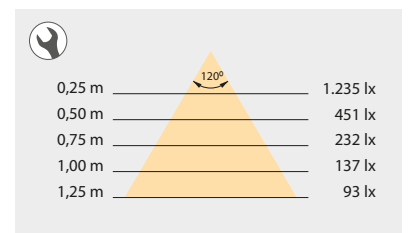
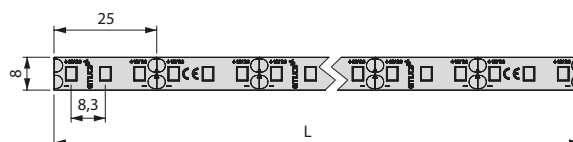



LED Strip Lynx Basic 9,6W/m IP20 (12V DC)

Taśma LED Lynx Basic 9,6W/m IP20

L	Efficiency Wydajność	Lumen	Power Moc	Colour temperature Temperatura koloru	LEDs	Finishing Wykończenie	Format Format	Cod.
5 m	69 lm / W	660 lm / m	9,6 W / m	Cold white 6.000 K Zimna biel 6.000 K	120 LEDs / m	Transparent / not defined Przezroczyste / nieokreślone		2 Ut/Szt 5200520
5 m	69 lm / W	660 lm / m	9,6 W / m	Warm white 3.000 K Ciepła biel 3.000 K	120 LEDs / m	Transparent / not defined Przezroczyste / nieokreślone		2 Ut/Szt 5200620

Plastic
Plastik





IP20   LED SMD 2835    3 LEDs         12V DC

LYNX BASIC (12V DC) // LYNX BASIC (12V DC)

LED Strip Lynx Basic 9,6W/m IP65 (12V DC)

Taśma LED Lynx Basic 9,6W/m IP65

L	Efficiency Wydajność	Lumen	Power Moc	Colour temperature Temperatura koloru	LEDs	Finishing Wykończenie	Format Format	Cod.
5 m	69 lm / W	660 lm / m	9,6 W / m	Cold white 6.000 K Zimna biel 6.000 K	120 LEDs / m	Transparent / not defined Przezroczyste / nieokreślone		2 Ut/Szt 5200720
5 m	69 lm / W	660 lm / m	9,6 W / m	Warm white 3.000 K Ciepła biel 3.000 K	120 LEDs / m	Transparent / not defined Przezroczyste / nieokreślone		2 Ut/Szt 5200820

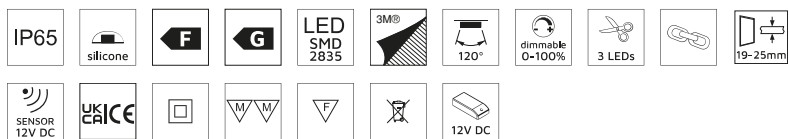
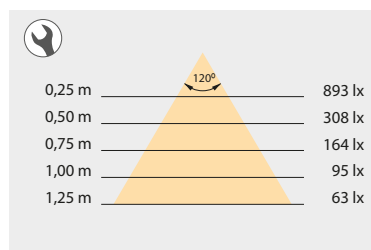
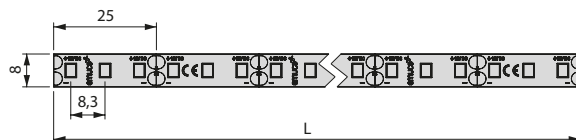
Plastic
Plastik

LYNX CONNECTORS (12V DC) // ZŁĄCZA LYNX (12V DC)

Lynx Z cable LED (12V DC)

Kabel LED Lynx Z (12V DC)

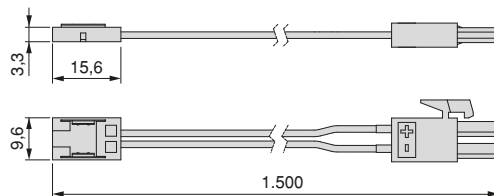
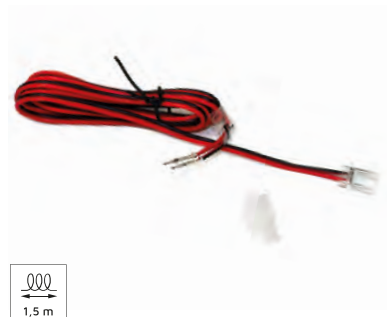

Finishing Wykończenie	Format Format	Cod.
Transparent / not defined Przezroczyste / nieokreślone	10 Ut/Szt	5207820

Plastic
Plastik



Lynx Z connector LED (12V DC) (24V DC)

Złącza LED Lynx Z (12V DC) (24V DC)

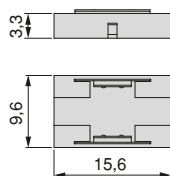

Finishing Wykończenie	Format Format	Cod.
Transparent / not defined Przezroczyste / nieokreślone	10 Ut/Szt	5208020

Plastic
Plastik

Lynx H cable LED (12V DC)

Kabel LED Lynx H (12V DC)

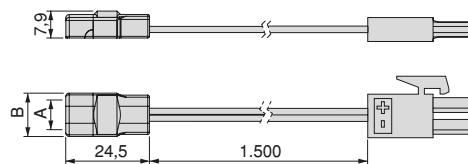

A	B	Finishing Wykończenie	Format Format	Cod.
8	12.7	Transparent / not defined Przezroczyste / nieokreślone	10 Ut/Szt	5061020



Plastic
Plastik



Lynx H connector LED (12V DC) (24V DC)

Złącza LED Lynx H (12V DC) (24V DC)

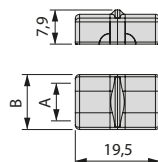

A	B	Finishing Wykończenie	Format Format	Cod.
8	12.7	Transparent / not defined Przezroczyste / nieokreślone	10 Ut/Szt	5061120



Plastic
Plastik

LYNX CONNECTORS (12V DC) // ZŁĄCZA LYNX (12V DC)

Lynx Q cable LED (12V DC)

Kabel LED Lynx Q (12V DC)

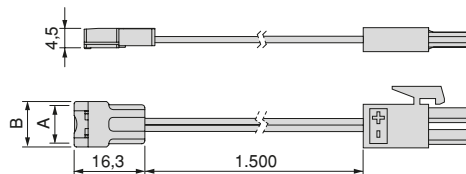

A	B	Finishing Wykończenie	Format Format	Cod.
8	10.5	Black plastic Czarny plastik		10 Ut/Szt 7015417

Plastic
Plastik



Lynx Q connector LED (12V DC)

Złączka LED Lynx Q (12V DC)

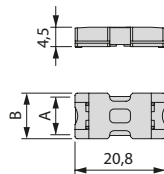

A	B	Finishing Wykończenie	Format Format	Cod.
8	10.5	Transparent / not defined Przezroczyste / nieokreślone		10 Ut/Szt 7015520

Plastic
Plastik

Lynx Q cable LED flexible (12V DC) (24V DC)

Złączka LED Lynx Q elastyczna (12V DC) (24V DC)

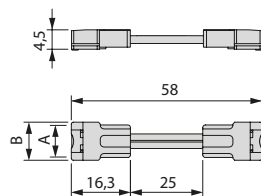

A	B	Finishing Wykończenie	Format Format	Cod.
8	10.5	Transparent / not defined Przezroczyste / nieokreślone		10 Ut/Szt 5203220

Plastic
Plastik

AMP extension cable (12V DC)

Przedłużacz AMP (12V DC)

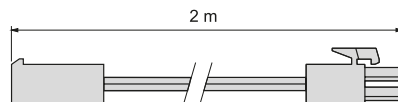

Longitude Długość	Finishing Wykończenie	Format Format	Cod.
2 m	Black plastic Czarny plastik		25 Ut/Szt 9269817

Plastic
Plastik



Lynx union L LED (12V DC) (24V DC)

Union L LED Lynx (12V DC) (24V DC)

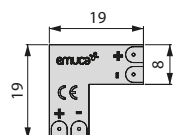

Finishing Wykończenie	Format Format	Cod.
Transparent / not defined Przezroczyste / nieokreślone		10 Ut/Szt 5202820

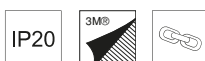

Plastic
Plastik



LYNX PREMIUM (24V DC) // LYNX PREMIUM (24V DC)







LED Strip Lynx Premium 4,8 W/m IP20 (24V DC)

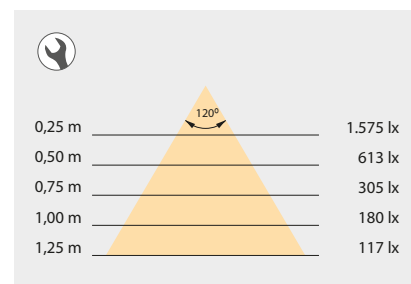
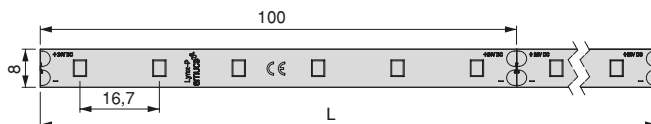







Taśma LED Lynx Premium 4,8 W/m IP20 (24V DC)

L	Efficiency Wydajność	Lumen	Power Moc	Colour temperature Temperatura koloru	LEDs	Finishing Wykończenie	Format Format	Cod.
10 m	91 lm / W	440 lm / m	4,8 W / m	Natural white 4.000 K Naturalna biel 4.000 K	60 LEDs / m	Transparent / not defined Przezroczyste / nieokreślone		1 Ut/Szt 5205120
10 m	91 lm / W	440 lm / m	4,8 W / m	Warm white 3.000 K Ciepła biel 3.000 K	60 LEDs / m	Transparent / not defined Przezroczyste / nieokreślone		1 Ut/Szt 5205220

Plastic
Plastik





IP20    CRI ≥80  LED SMD 2835  DOUBLE PCB  120°  max. 14 m

 dimmable 0-100%  100mm   SENSOR 24V DC      24V DC







LED Strip Lynx Premium 9,6 W/m IP20 (24V DC)

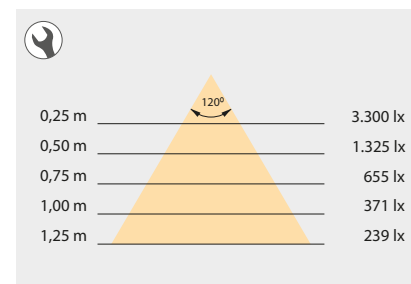
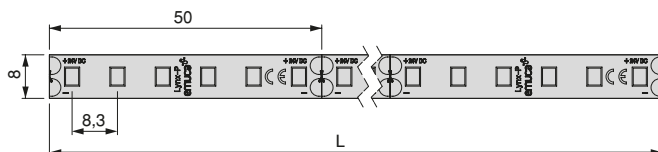







Taśma LED Lynx Premium 9,6 W/m IP20 (24V DC)

L	Efficiency Wydajność	Lumen	Power Moc	Colour temperature Temperatura koloru	LEDs	Finishing Wykończenie	Format Format	Cod.
10 m	94 lm / W	910 lm / m	9,6 W / m	Natural white 4.000 K Naturalna biel 4.000 K	120 LEDs / m	Transparent / not defined Przezroczyste / nieokreślone		1 Ut/Szt 5205320
10 m	94 lm / W	910 lm / m	9,6 W / m	Warm white 2.700 K Ciepła biel 2.700 K	120 LEDs / m	Transparent / not defined Przezroczyste / nieokreślone		1 Ut/Szt 5205420

Plastic
Plastik





IP20    CRI ≥80  LED SMD 2835  DOUBLE PCB  120°  max. 14 m

 dimmable 0-100%  100mm   SENSOR 24V DC      24V DC

LYNX PREMIUM COB (24V DC) // LYNX PREMIUM COB (24V DC)

LED Strip Lynx Premium COB 9,6 W/m IP20 (24V DC)

Taśma LED Lynx Premium COB 9,6 W/m IP20 (24V DC)

L	Efficiency Wydajność	Lumen	Power Moc	Colour temperature Temperatura koloru	LEDs	Finishing Wykończenie	Format Format	Cod.
5 m	75 lm / W	721 lm / m	9,6 W / m	Warm white 2.700 K Ciepła biel 2.700 K	378 LEDs / m	Transparent / not defined Przezroczyste / nieokreślone		2 Ut/Szt 5207620
5 m	88 lm / W	849 lm / m	9,6 W / m	Natural white 4.000 K Naturalna biel 4.000 K	378 LEDs / m	Transparent / not defined Przezroczyste / nieokreślone		2 Ut/Szt 5207720

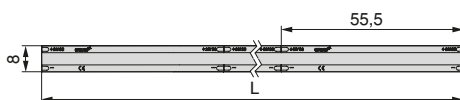
Plastic
Plastik



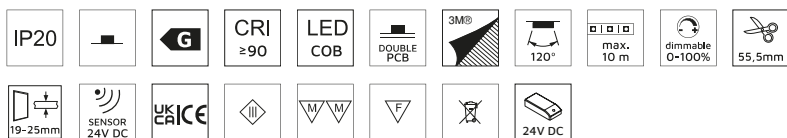



0,25 m	1440 lx
0,50 m	645 lx
0,75 m	326 lx
1,00 m	202 lx
1,25 m	137 lx



NEONLYNX (24 V DC) // NEONLYNX (24 V DC)









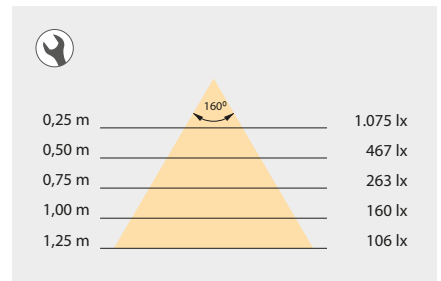
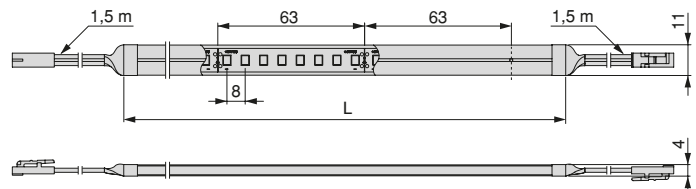







LED Strip Neonlynx 7,6W/m IP65 (24V DC)

Taśma LED Neonlynx 7,6W/m IP65 (24V DC)

L	Efficiency Wydajność	Lumen	Power Moc	Colour temperature Temperatura koloru	LEDs	Finishing Wykończenie	Format Format	Cod.
1.008 mm	49 lm / W	375 lm / m	7,6 W / m	Natural white 4.000 K Naturalna biel 4.000 K	128 LEDs / m	Transparent / not defined Przezroczyste / nieokreślone		8 Ut/Szt 5204220
3.024 mm	49 lm / W	375 lm / m	7,6 W / m	Natural white 4.000 K Naturalna biel 4.000 K	128 LEDs / m	Transparent / not defined Przezroczyste / nieokreślone		2 Ut/Szt 5204320
5.040 mm	49 lm / W	375 lm / m	7,6 W / m	Natural white 4.000 K Naturalna biel 4.000 K	128 LEDs / m	Transparent / not defined Przezroczyste / nieokreślone		2 Ut/Szt 5204420
1.008 mm	49 lm / W	370 lm / m	7,6 W / m	Warm white 2.700 K Ciepła biel 2.700 K	128 LEDs / m	Transparent / not defined Przezroczyste / nieokreślone		8 Ut/Szt 5206020
3.024 mm	49 lm / W	370 lm / m	7,6 W / m	Warm white 2.700 K Ciepła biel 2.700 K	128 LEDs / m	Transparent / not defined Przezroczyste / nieokreślone		2 Ut/Szt 5206120
5.040 mm	49 lm / W	370 lm / m	7,6 W / m	Warm white 2.700 K Ciepła biel 2.700 K	128 LEDs / m	Transparent / not defined Przezroczyste / nieokreślone		2 Ut/Szt 5206220

Plastic
Plastik



										
										



LYNX CONNECTORS (24V DC) // ZŁĄCZA LYNX (24V DC)

Lynx Z cable LED (24V DC)

Kabel LED Lynx Z (24V DC)

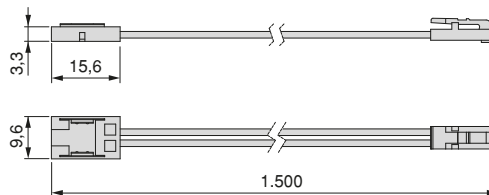

Finishing Wykończenie	Format Format	Cod.
Transparent / not defined Przezroczyste / nieokreślone	10 Ut/Szt	5207920

Plastic
Plastik

Lynx Z connector LED (12V DC) (24V DC)

Złącza LED Lynx Z (12V DC) (24V DC)

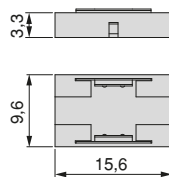

Finishing Wykończenie	Format Format	Cod.
Transparent / not defined Przezroczyste / nieokreślone	10 Ut/Szt	5208020

Plastic
Plastik

Lynx H cable LED (24V DC)

Kabel LED Lynx H (24V DC)

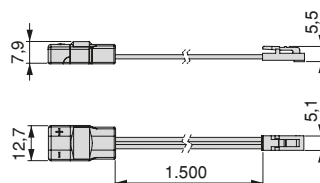

Finishing Wykończenie	Format Format	Cod.
Transparent / not defined Przezroczyste / nieokreślone	10 Ut/Szt	5204820

Plastic
Plastik

Lynx H connector LED (12V DC) (24V DC)

Złącza LED Lynx H (12V DC) (24V DC)

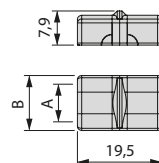

A	B	Finishing Wykończenie	Format Format	Cod.
8	12.7	Transparent / not defined Przezroczyste / nieokreślone	10 Ut/Szt	5061120

Plastic
Plastik

LYNX CONNECTORS (12V DC) // ZŁĄCZA LYNX (12V DC)

Miniled cable extension (24V DC)

Przedłużacz MiniLED (24 V DC)

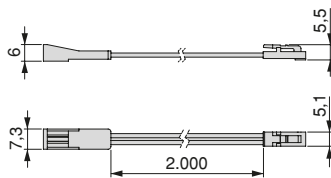

Finishing Wykończenie	Format Format	Cod.
Transparent / not defined Przezroczyste / nieokreślone	25 Ut/Szt	5204920

Plastic
Plastik

Lynx Q cable LED flexible (12V DC) (24V DC)

Złącza LED Lynx Q elastyczna (12V DC) (24V DC)

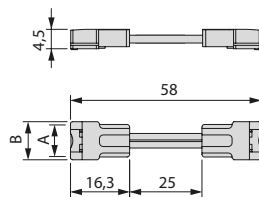

A	B	Finishing Wykończenie	Format Format	Cod.
8	10.5	Transparent / not defined Przezroczyste / nieokreślone	10 Ut/Szt	5203220

Plastic
Plastik

AMP to Miniled adaptor set for sensors (12V DC) (24V DC)

Zestaw adapterów AMP do MiniLED do czujników (12V DC) (24V DC)

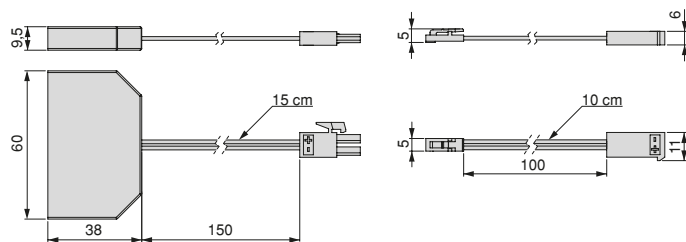

Finishing Wykończenie	Format Format	Cod.
Transparent / not defined Przezroczyste / nieokreślone	10 Ut/Szt	5205020

Plastic
Plastik

Lynx union L LED (12V DC) (24V DC)

Union L LED Lynx (12V DC) (24V DC)

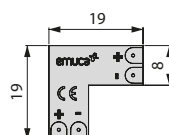

Finishing Wykończenie	Format Format	Cod.
Transparent / not defined Przezroczyste / nieokreślone	10 Ut/Szt	5202820

Plastic
Plastik



DETECTORS // CZUJNIKI

Sensor for LED strip Lynx Z Motion (12V DC) (24V DC)

Lynx Z Motion (12V DC) (24V DC) czujnik do taśm LED

Power Moc	Input	Output	Finishing Wykończenie	Format Format	Cod.
60W/72W	12/24V DC 12/24V DC	12/24V DC 12/24V DC	Transparent / not defined Przezroczyste / nieokreślone	<input type="checkbox"/>	10 Ut/Szt 5208220

Plastic
Plastik

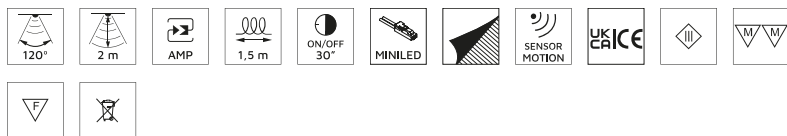
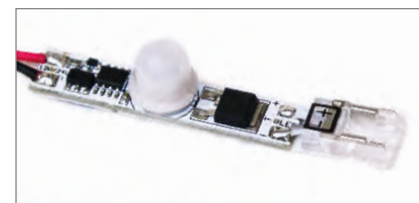
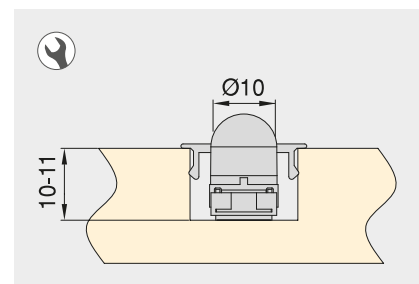
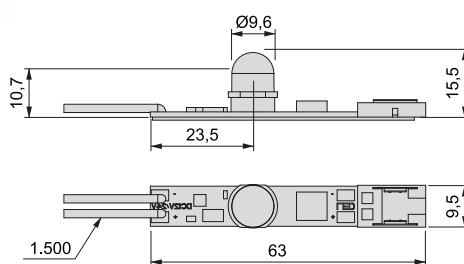

Sensor for LED strip Lynx Z Touch Dimmer (12V DC) (24V DC)

Lynx Z Touch Dimmer (12V DC) (24V DC) czujnik do taśm LED

Power Moc	Input	Output	Finishing Wykończenie	Format Format	Cod.
60W/72W	12/24V DC 12/24V DC	12/24V DC 12/24V DC	Transparent / not defined Przezroczyste / nieokreślone	<input type="checkbox"/>	10 Ut/Szt 5208120

Plastic
Plastik

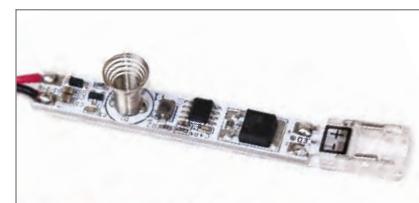
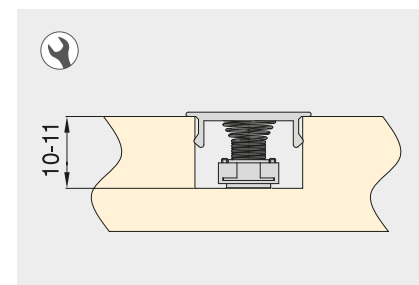
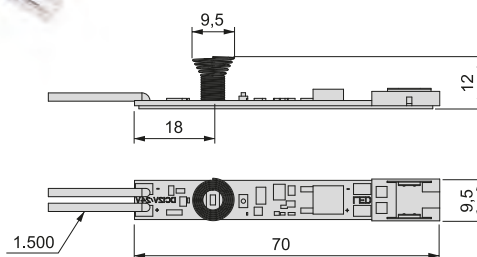

PROFILES LYNX W // PROFILE LYNX W

Lynx W diffuser profile for LED strip

Profil rozpraszający Lynx W do taśmy LED

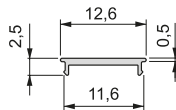

Longitude Długość	Finishing Wykończenie	Format Format	Cod.
2,35 m	White plastic Biały plastik	20 Ut/Szt	5147815
2,35 m	Black plastic Czarny plastik	20 Ut/Szt	5147817

Plastic
Plastik

Profile Lynx W for recessed installation for LED strip

Profil Lynx W do montażu wpuszczanego na taśmę LED

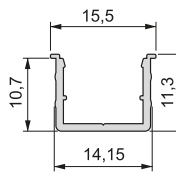

Longitude Długość	Finishing Wykończenie	Format Format	Cod.
2,35 m	Matte anodized Anodyzowany mat	20 Ut/Szt	5147962
2,35 m	Black anodized Czarny anodowany	20 Ut/Szt	5147967

Aluminium
Aluminium

Accessory for recessed installation in aluminum Lynx W profile

Akcesoria do montażu wpuszczanego w profilu aluminiowym Lynx W.

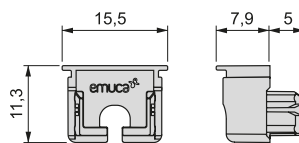

Finishing Wykończenie	Format Format	Cod.
Grey plastic Szary plastik	20 Ut/Szt	5148421
Black plastic Czarny plastik	20 Ut/Szt	5148417

Plastic
Plastik

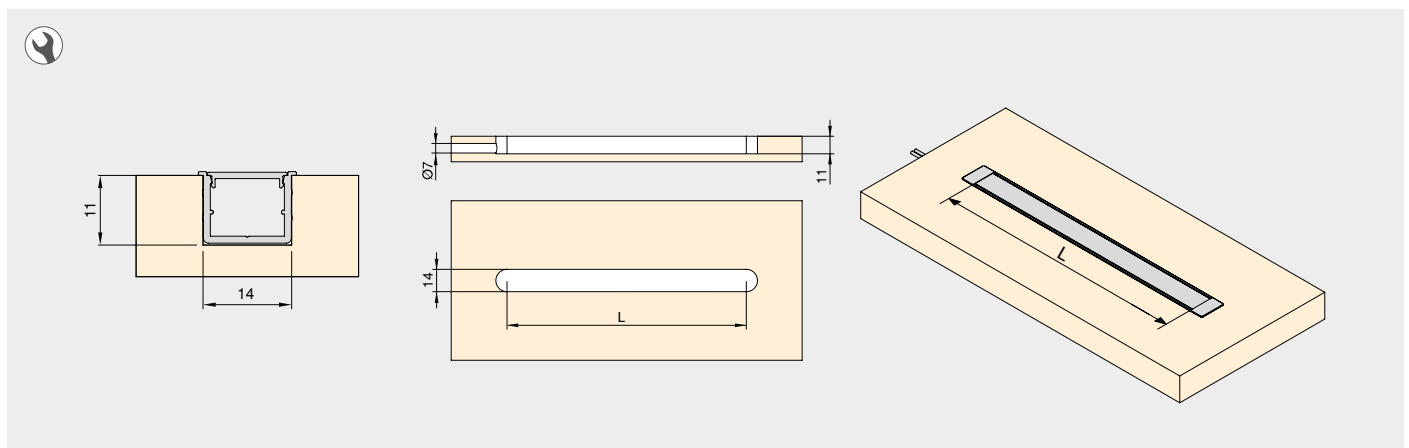

PROFILES LYNX W // PROFILE LYNX W

Surfacemount Lynx W profile for LED strip

Profil Surfacemount Lynx W do taśmy LED

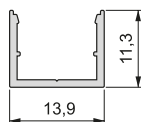

Longitude Długość	Finishing Wykończenie	Format Format	Cod.
2,35 m	Matt anodized Anodyzowany mat	20 Ut/Szt	5148062
2,35 m	Black anodized Czarny anodowany	20 Ut/Szt	5148067

Aluminium
Aluminium

Accessories for surfacemount Lynx W profile

Akcesoria do profilu powierzchniowego Lynx W.

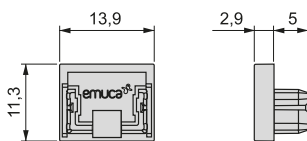

Finishing Wykończenie	Format Format	Cod.
Grey plastic Szary plastik	10 Ut/Szt	5148521
Black plastic Czarny plastik	10 Ut/Szt	5148517

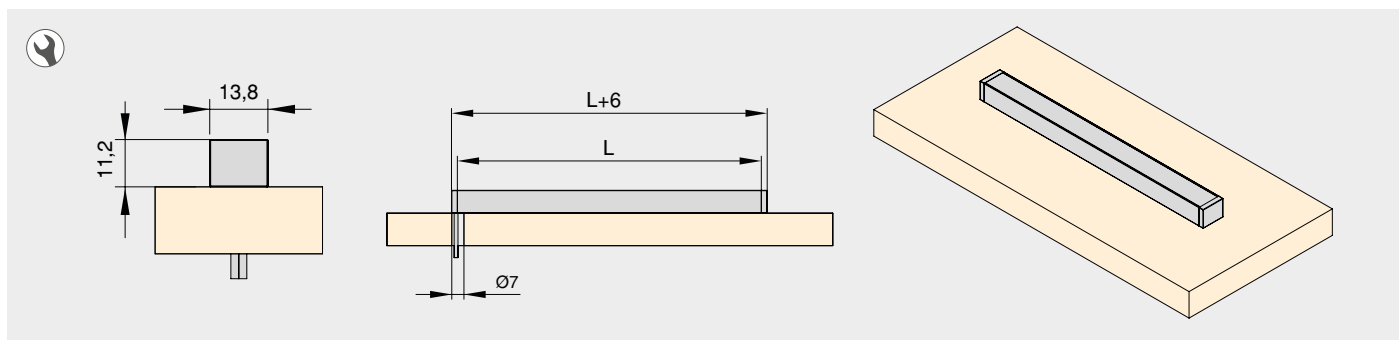
Plastic
Plastik





PROFILES LYNX W // PROFILE LYNX W

Profiles Lynx W for recessed installation for LED strip

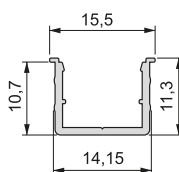
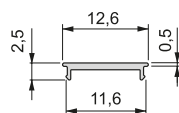
Profile Lynx W do montażu podtynkowego do taśm LED



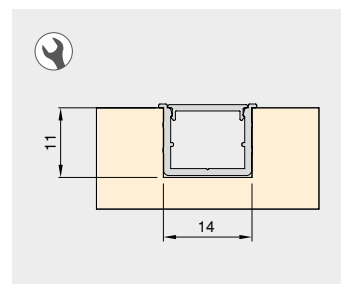

Longitude Długość	Finishing Wykończenie	Format Format	Cod.
2,35 m	Matt anodized Anodyzowany mat	 8 Ut/Szt	5148962
2,35 m	Black anodized Czarny anodowany	 8 Ut/Szt	5148967

Aluminium
Aluminium

Surfacemount Lynx W profiles for LED strip

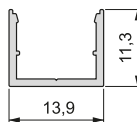
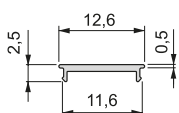
Profile Surfacemount Lynx W do taśm LED

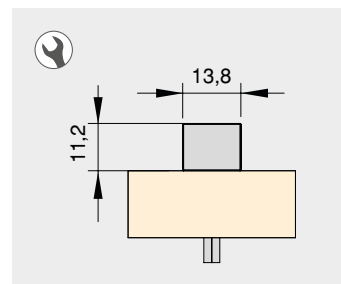

Longitude Długość	Finishing Wykończenie	Format Format	Cod.
2,35 m	Matt anodized Anodyzowany mat	 8 Ut/Szt	5149062
2,35 m	Black anodized Czarny anodowany	 8 Ut/Szt	5149067

Aluminium
Aluminium

PROFILES LYNX // PROFILE LYNX

Flat diffuser profile for LED strip

Płaski profil dyfuzora do taśm LED

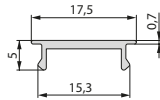

Longitude Długość	Finishing Wykończenie	Format Format	Cod.
2,35 m	White plastic Biały plastik	20 Ut/Szt	5147115
3,9 m	White plastic Biały plastik	20 Ut/Szt	5146415

Plastic
Plastik



Accessories for recessed installation in wood the flat diffuser profile

Akcesoria do montażu wpuszczanego w drewnie, płaski profil nawiewnika

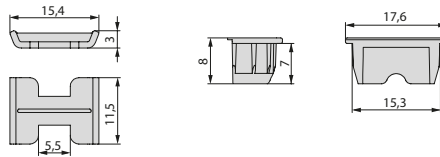

Finishing Wykończenie	Format Format	Cod.
Grey plastic Szary plastik	10 Ut/Szt	5146821

Plastic
Plastik

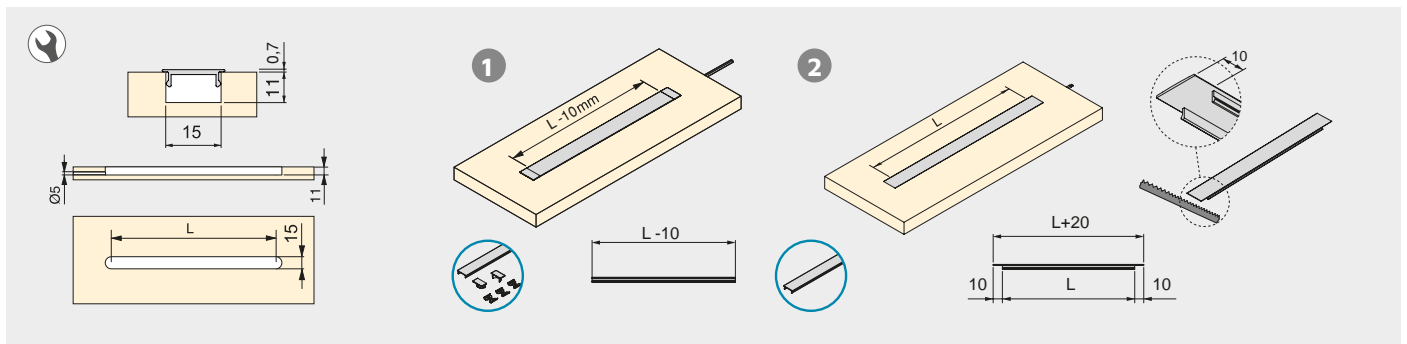

PROFILES LYNX // PROFILE LYNX

Flat profile for recessed installation for LED strip

Płaski profil do osadzania do taśm LED

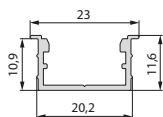

Longitude Długość	Finishing Wykończenie	Format Format	Cod.
2,35 m	Matt anodized Anodyzowany mat	20 Ut/Szt	5085262
3,9 m	Matt anodized Anodyzowany mat	20 Ut/Szt	5146762

Aluminium
Aluminium

Accessory for recessed installation in aluminum profile the flat diffuser profile

Akcesoria do montażu wpuszczanego w profilu aluminiowym - płaski profil nawiewnika

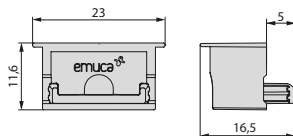

Finishing Wykończenie	Format Format	Cod.
Grey plastic Szary plastik	20 Ut/Szt	5146921

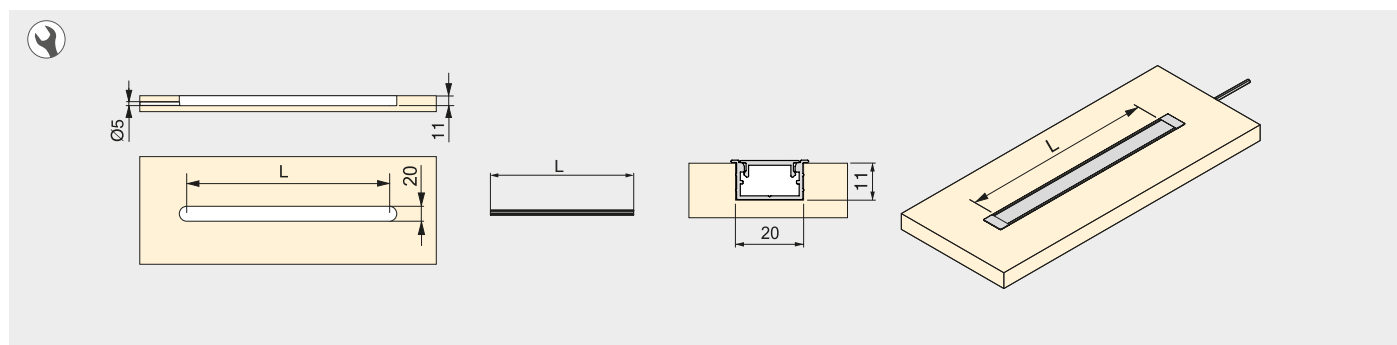
Plastic
Plastik



PROFILES LYNX // PROFILE LYNX

Curved diffuser profile for LED strip

Zakrzywiony profil dyfuzora do taśm LED

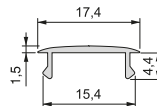

Longitude Długość	Finishing Wykończenie	Format Format	Cod.
2,35 m	White plastic Biały plastik	20 Ut/Szt	5147015
2,9 m	White plastic Biały plastik	20 Ut/Szt	5147215

Plastic
Plastik

Profile for recessed installation for LED strip

Profil do osadzenia do taśm LED

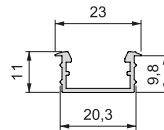

Longitude Długość	Finishing Wykończenie	Format Format	Cod.
2,35 m	Matt anodized Anodyzowany mat	20 Ut/Szt	5085162
2,9 m	Matt anodized Anodyzowany mat	20 Ut/Szt	5085462

Aluminium
Aluminium

Accessory for recessed installation in aluminum profile the curved diffuser profile

Akcesoria do montażu wpuszczanego w profilu aluminiowym zakrzywiony profil nawiewnika

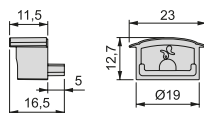

Finishing Wykończenie	Format Format	Cod.
Grey plastic Szary plastik	20 Ut/Szt	5144221

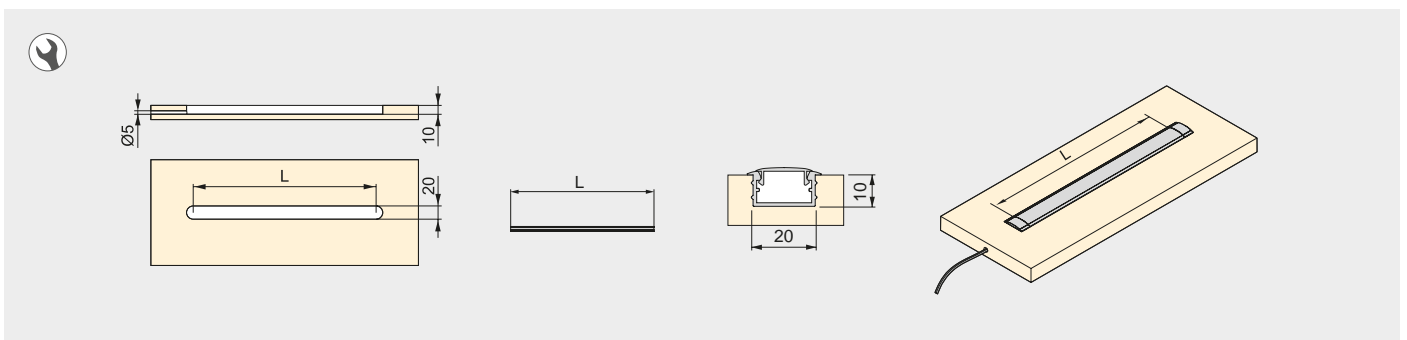
Plastic
Plastik

PROFILES LYNX // PROFILE LYNX

Surfacemount profile for LED strip

Profil do powierzchni do taśm LED

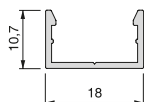

Longitude Długość	Finishing Wykończenie	Format Format	Cod.
2,35 m	Matt anodized Anodyzowany mat	20 Ut/Szt	5085062

Aluminium
Aluminium



Accessories for surfacemount profile

Akcesoria do profilu do montażu powierzchniowego

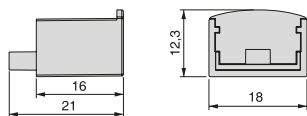

Finishing Wykończenie	Format Format	Cod.
Grey plastic Szary plastik	10 Ut/Szt	5143421

Plastic
Plastik

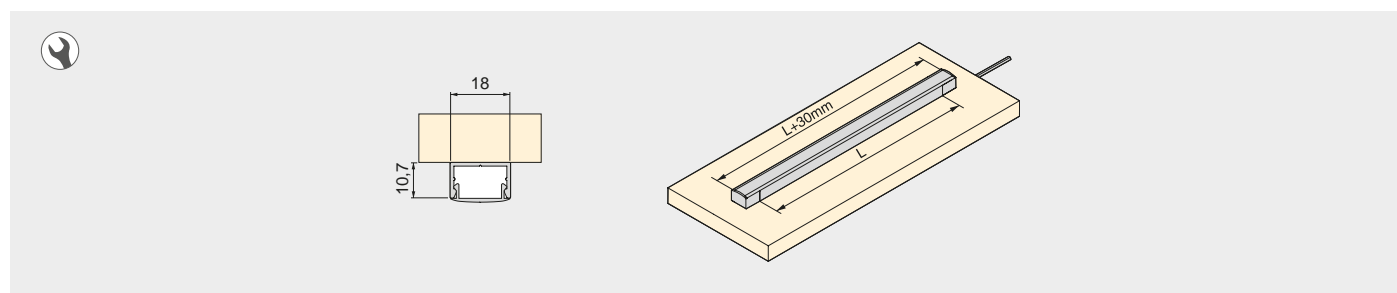

PROFILES LYNX // PROFILE LYNX

Profile for inclined surface for LED strip

Nachylony profil do powierzchni do taśm LED

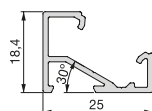

Longitude Długość	Finishing Wykończenie	Format Format	Cod.
2,35 m	Matt anodized Anodyzowany mat	20 Ut/Szt	5085362
2,9 m	Matt anodized Anodyzowany mat	20 Ut/Szt	5085662

Aluminium
Aluminium

Accessories for inclined surface profile

Akcesoria do nachylonych profili powierzchniowych

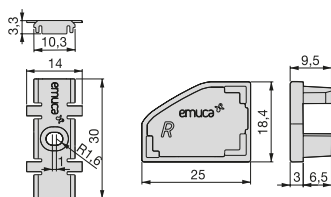

Finishing Wykończenie	Format Format	Cod.
Grey plastic Szary plastik	10 Ut/Szt	5146321

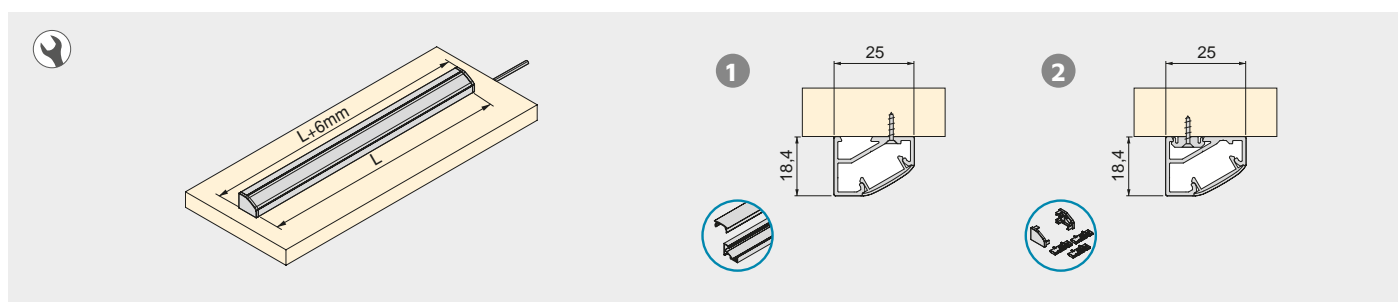
Plastic
Plastik

PROFILES LYNX // PROFILE LYNX

Profiles Lynx for recessed installation for LED strip

Profile Lynx for recessed installation do taśm LED

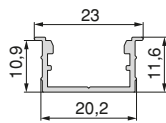
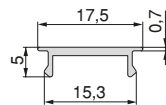

Longitude Długość	Finishing Wykończenie	Format Format	Cod.
2,35 m	Matt anodized Anodyzowany mat	 8 Ut/Szt	5148662

Aluminium
Aluminium

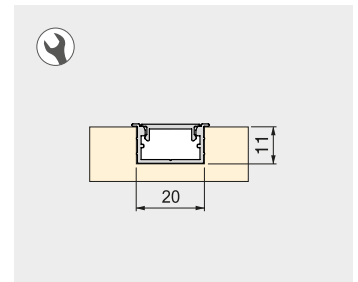

Surfacemount Lynx profiles for LED strip

Surfacemount Lynx profile do taśm LED

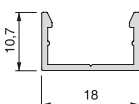
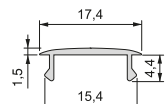

Longitude Długość	Finishing Wykończenie	Format Format	Cod.
2,35 m	Matt anodized Anodyzowany mat	 8 Ut/Szt	5148762

Aluminium
Aluminium

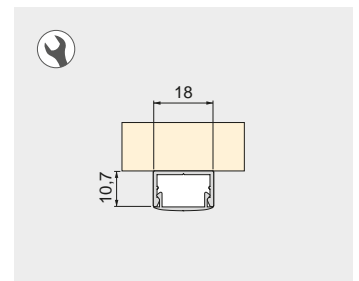

Lynx inclined surface profiles for LED strips

Nachylony profile do powierzchni do taśm LED

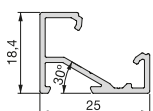
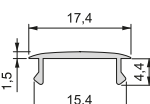

Longitude Długość	Finishing Wykończenie	Format Format	Cod.
2,35 m	Matt anodized Anodyzowany mat	 6 Ut/Szt	5148862

Aluminium
Aluminium

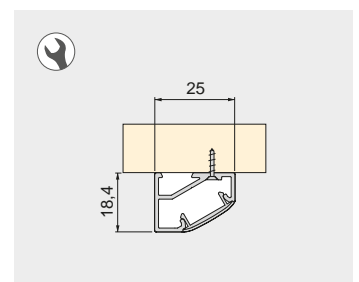

PROFILES LYNX // PROFILE LYNX

LED Wall Lamps Built-in Diflex

Kinkiet LED Wbudowany Diflex

A	L	Lumen	Power Moc	Colour temperature Temperatura koloru	LEDs	Finishing Wykończenie	Format Format	Cod.
362	340	113 lm	2,7 W	Cold white 6.000 K Zimna biel 6.000 K	30	Matt anodized Anodyzowany mat	10 Ut/Szt	5144362
562	540	203 lm	4,6 W	Cold white 6.000 K Zimna biel 6.000 K	54	Matt anodized Anodyzowany mat	10 Ut/Szt	5144462

Aluminium, Plastik
Aluminium, Plastik

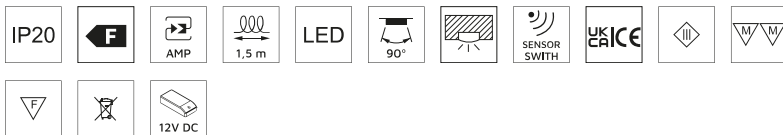
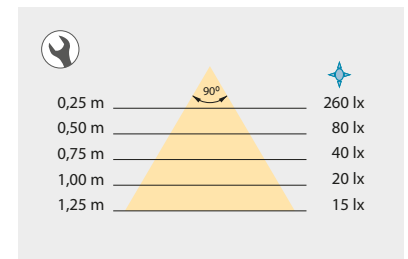
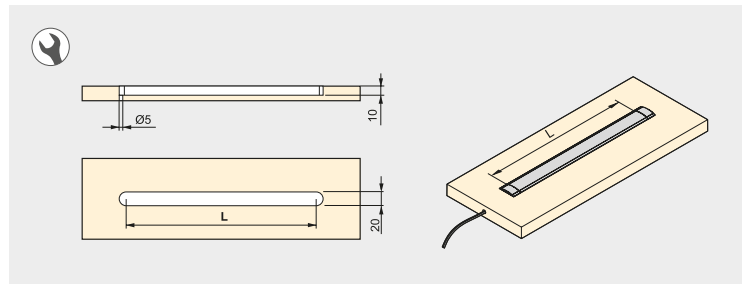
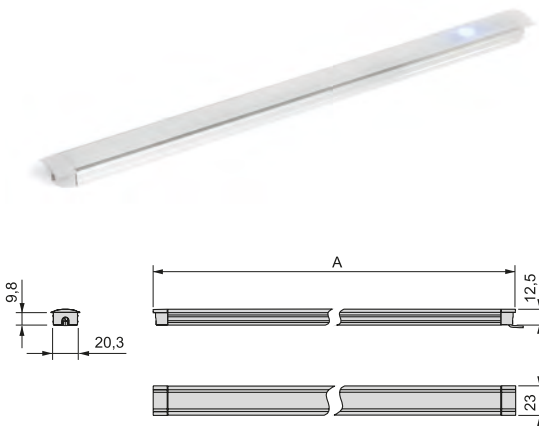

LED Wall Lamps Surface Diflex

Kinkiet LED Diflex montowany na powierzchni

A	Lumen	Power Moc	Colour temperature Temperatura koloru	LEDs	Finishing Wykończenie	Format Format	Cod.
350	101 lm	2,4 W	Cold white 6.000 K Zimna biel 6.000 K	27	Matt anodized Anodyzowany mat	10 Ut/Szt	5144562
550	182 lm	4,3 W	Cold white 6.000 K Zimna biel 6.000 K	54	Matt anodized Anodyzowany mat	10 Ut/Szt	5144662

Aluminium, Plastik
Aluminium, Plastik

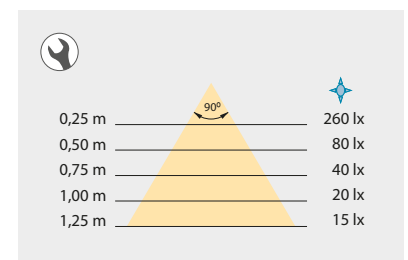
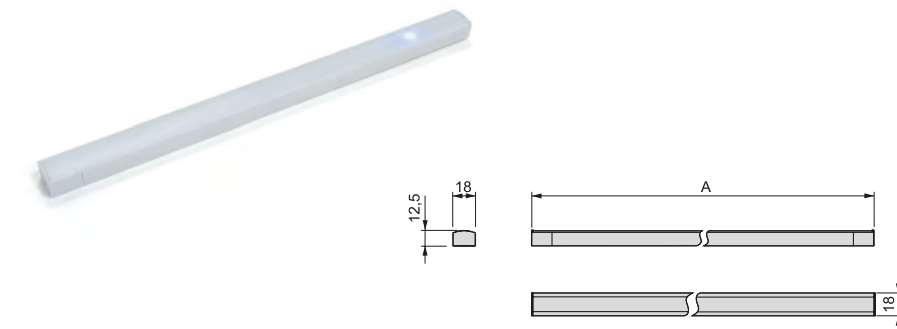

LED LIGHTS

ŚWIATŁA LED



LIGHTS // KINKIETY

LED panel Andromeda (12V DC)

Panel LED Andromeda (12V DC)

Lumen	Power Moc	Colour temperature Temperatura koloru	LEDs	Finishing Wykończenie	Format Format	Cod.
400 lm	5 W	Cold white 6.000 K Zimna biel 6.000 K	54	White plastic Biały plastik		5 Ut/Szt 5915115

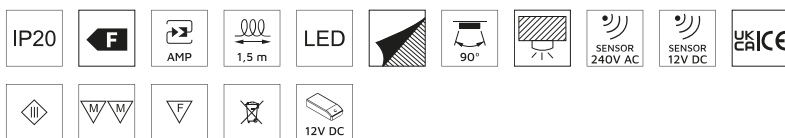
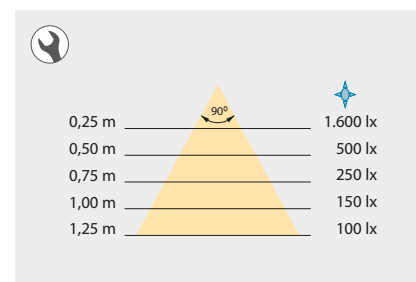
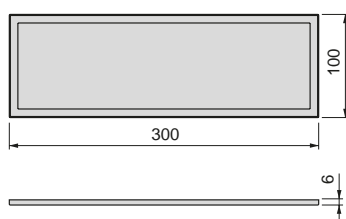
Aluminium, Plastic
Aluminium, Plastik

LED Wall Lamps Auriga (12V DC)

Kinkiet LED Auriga (12V DC)

Lumen	Power Moc	Colour temperature Temperatura koloru	LEDs	Finishing Wykończenie	Format Format	Cod.
205 lm	2,5 W	Natural white 4.000 K Naturalna biel 4.000 K	6	Matt anodized Anodyzowany mat		5 Ut/Szt 5204162

Aluminium, Plastic
Aluminium, Plastik

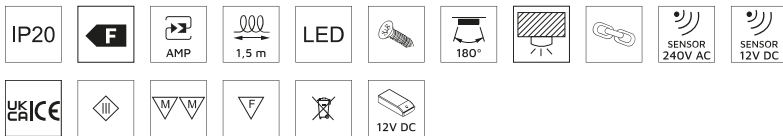
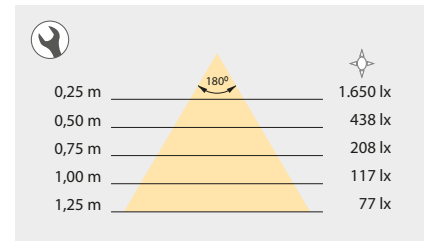
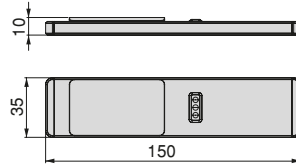

LED Wall Lamps Auriga switch (12V DC)

Kinkiet LED Auriga switch (12V DC)

Lumen	Power Moc	Colour temperature Temperatura koloru	LEDs	Finishing Wykończenie	Format Format	Cod.
205 lm	2,5 W	Natural white 4.000 K Naturalna biel 4.000 K	6	Matt anodized Anodyzowany mat		5 Ut/Szt 5204062

Aluminium, Plastic
Aluminium, Plastik

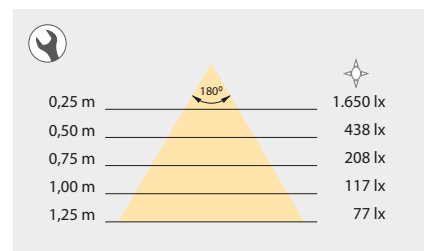
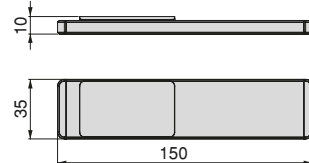

LIGHTS // KINKIETY

LED Wall Lamps Kuma circular (12V DC)

Kinkiet LED Kuma (12V DC)



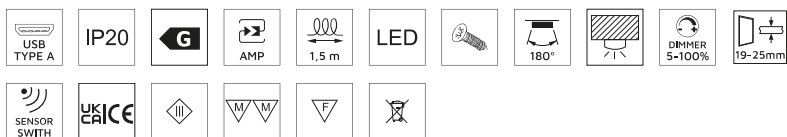
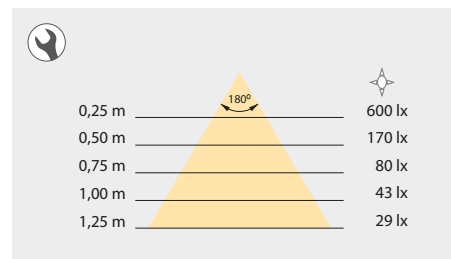
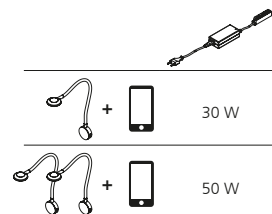
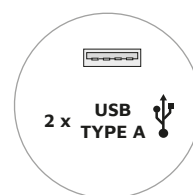
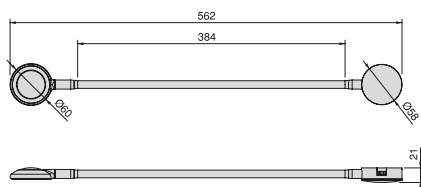

Lumen	Power Moc	Colour temperature Temperatura koloru	LEDs	Finishing Wykończenie	Format Format	Cod.
150 lm	2,1 W	Natural white 4.000 K Naturalna biel 4.000 K	16	White plastic Biały plastik		4 Ut/Szt 5029315

Plastic
Plastik

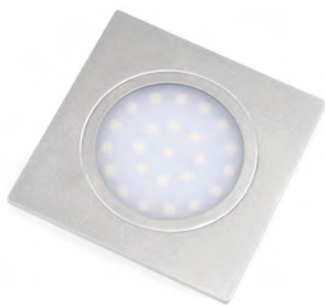
LED spotlight Crux-in-Q (AC 230V 50Hz)

Światło LED Crux-in-Q (AC 230V 50Hz)



Lumen	Power Moc	Colour temperature Temperatura koloru	LEDs	Finishing Wykończenie	Format Format	Cod.
101 lm	1,8 W	Natural white 4.000 K Naturalna biel 4.000 K	24	White painted Malowane na biało		6 Ut/Szt 5203912
101 lm	1,8 W	Natural white 4.000 K Naturalna biel 4.000 K	24	Black painted Malowane na czarno		6 Ut/Szt 5203914
101 lm	1,8 W	Natural white 4.000 K Naturalna biel 4.000 K	24	Silver painted Malowane aluminium		6 Ut/Szt 5203925
101 lm	1,8 W	Natural white 4.000 K Naturalna biel 4.000 K	24	Satin finished nickel Nikiel satynowy		6 Ut/Szt 5203951

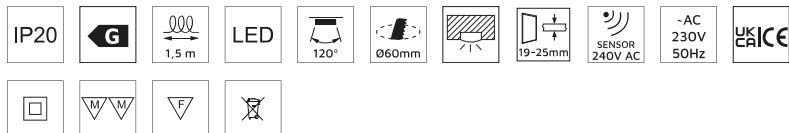
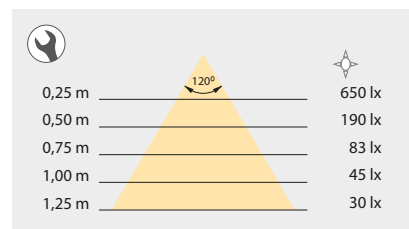
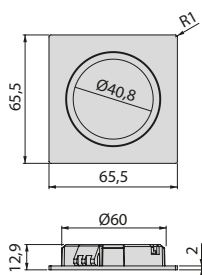

Plastic
Plastik



SPOTS // PUNKT

Crux-in LED luminaire for embedding in furniture without the need for a converter (AC 230V 50Hz)

Oprawa Crux-in LED do osadzania w meblach bez potrzeby stosowania konwertera (AC 230V 50Hz)

Lumen	Power Moc	Colour temperature Temperatura koloru	LEDs	Finishing Wykończenie	Format Format	Cod.
116 lm	1,8 W	Cold white 6.000 K Zimna biel 6.000 K	24	Silver painted Malowane aluminium		6 Ut/Szt 5915225
116 lm	1,8 W	Cold white 6.000 K Zimna biel 6.000 K	24	Satin finished nickel Nikiel satynowy		6 Ut/Szt 5915251
116 lm	1,8 W	Natural white 4.000 K Naturalna biel 4.000 K		Satin finished nickel Nikiel satynowy		6 Ut/Szt 5915351

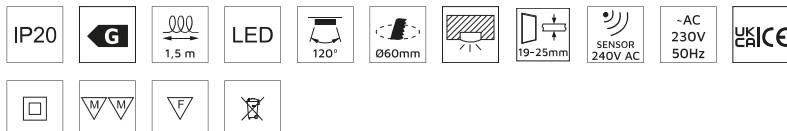
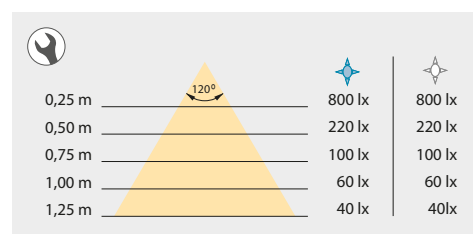
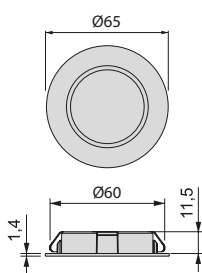
Plastic
Plastik

SPOTS // PUNKT

LED spotlight Crux (12V DC)

Światło LED Crux (12V DC)



Lumen	Power Moc	Colour temperature Temperatura koloru	LEDs	Finishing Wykończenie	Format Format	Cod.
105 lm	1,8 W	Cold white 6.000 K Zimna biel 6.000 K	24	Silver painted Malowane aluminium	6 Ut/Szt	5914525
110 lm	1,8 W	Natural white 4.500 K Naturalna biel 4.500 K	24	Silver painted Malowane aluminium	6 Ut/Szt	5914625
105 lm	1,8 W	Cold white 6.000 K Zimna biel 6.000 K	24	Satin finished nickel Nikiel satynowy	6 Ut/Szt	5914551
110 lm	1,8 W	Natural white 4.500 K Naturalna biel 4.500 K	24	Satin finished nickel Nikiel satynowy	6 Ut/Szt	5914651

Plastic
Plastik

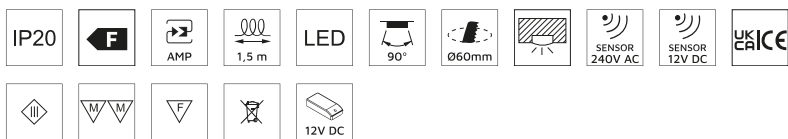
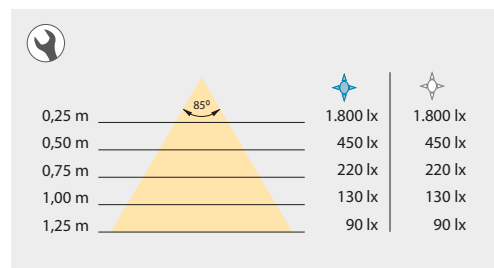
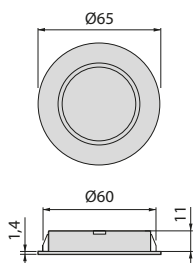

Crux ring for LED spotlight

Wspornik do oświetlenia LED

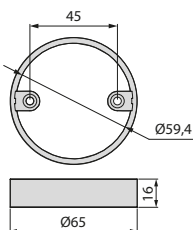

Finishing Wykończenie	Format Format	Cod.
Satin finished nickel Nikiel satynowy	6 Ut/Szt	5915551

Plastic
Plastik

Triangular support for LED spotlight

Wspornik do oświetlenia LED

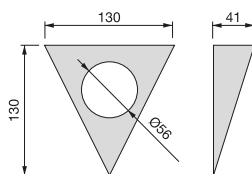

Finishing Wykończenie	Format Format	Cod.
Satin finished nickel Nikiel satynowy	10 Ut/Szt	7056851

Steel
Stal

SPOTS // PUNKT

Mizar LED luminaire for embedding in furniture without the need for a converter (AC 230V 50Hz)

Mizar LED do osadzenia w meblach bez potrzeby stosowania konwertera (AC 230V 50Hz)

A	Diametre Średnica	Lumen	Power Moc	Colour temperature Temperatura koloru	LEDs	Finishing Wykończenie	Format Format	Cod.
66	66	200 lm	3 W	Natural white 4.000 K Naturalna biel 4.000 K	24	Black painted Malowane na czarno	6 Ut/Szt	5040114
66	66	200 lm	3 W	Natural white 4.000 K Naturalna biel 4.000 K	24	Satin finished nickel Nikiel satynowy	6 Ut/Szt	5040151

Plastic, Steel
Plastik, Stal

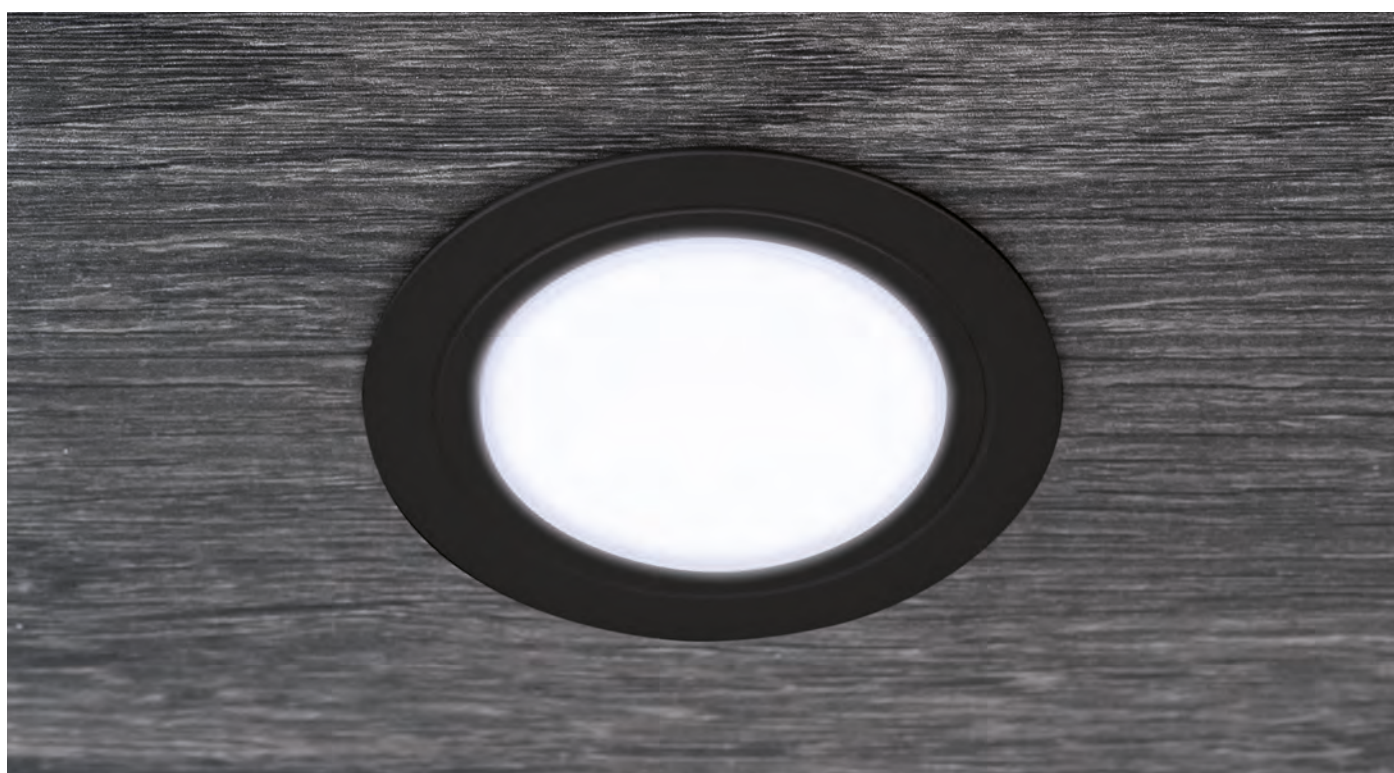
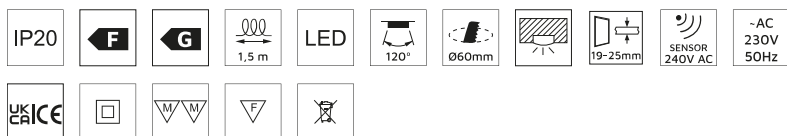
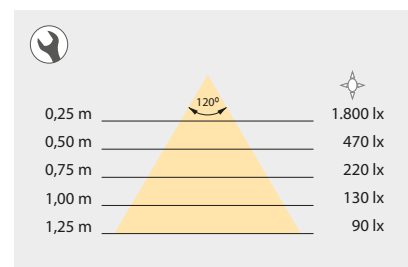
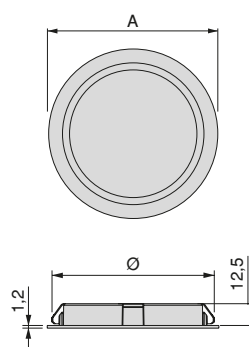

SPOTS // PUNKT

LED spotlight Spot (12V DC)

Światło LED Spot (12V DC)

Lumen	Power Moc	Colour temperature Temperatura koloru	LEDs	Finishing Wykończenie	Format Format	Cod.
8 lm	0,3 W	Cold white 6.000 K Zimna biel 6.000 K	1	Chrome plated Chromowane	10 Ut/Szt	7015611

Plastic
Plastik

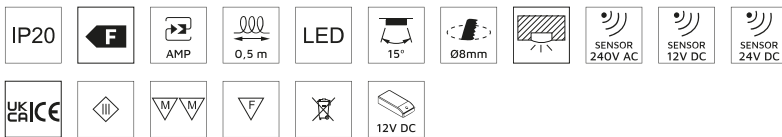
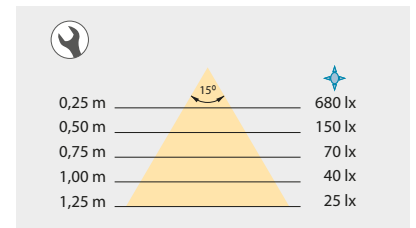
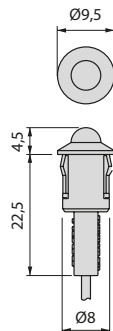

LED spotlight Alcor (12V DC)

Światło LED Alcor (12V DC)

Lumen	Power Moc	Colour temperature Temperatura koloru	LEDs	Finishing Wykończenie	Format Format	Cod.
95 lm	1,2 W	Natural white 4.000 K Naturalna biel 4.000 K	1	Matt anodized Anodyzowany mat	6 Ut/Szt	5022362

Aluminium
Aluminium

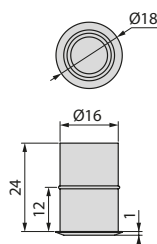

SPOTS // PUNKT

LED spotlight Polaris (12V DC)

Światło LED Polaris (12V DC)

Lumen	Power Moc	Colour temperature Temperatura koloru	LEDs	Finishing Wykończenie	Format Format	Cod.
95 lm	1,2 W	Natural white 4.000 K Naturalna biel 4.000 K	1	Matt anodized Anodyzowany mat		6 Ut/Szt 5022262

Aluminium
Aluminium

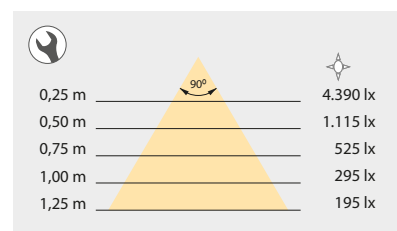
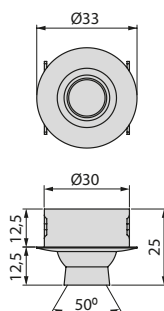

LED spotlight Merak (12V DC)

Światło LED Merak (12V DC)

Lumen	Power Moc	Colour temperature Temperatura koloru	LEDs	Finishing Wykończenie	Format Format	Cod.
60 lm	0,8 W	Natural white 4.000 K Naturalna biel 4.000 K	1	Silver painted Malowane aluminium		6 Ut/Szt 5027825

Plastic
Plastik

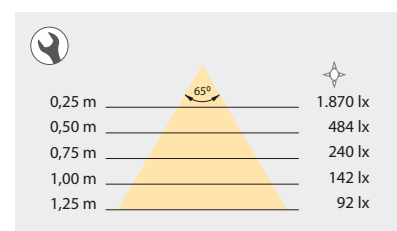
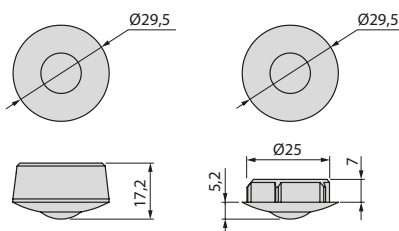

ILLUMINATED HANGING BARS // PODŚWIETLANE DRAŻKI NA WIESZAKI

Castor Hanging wardrobe bar with LED light, removable battery and motion sensor

Drażek do szafy z oświetleniem LED, wymienna bateria, czujnik ruchu, Castor



A	L	Cut Obcinane	Lumen	Power Moc	Colour temperature Temperatura koloru	LEDs	Finishing Wykończenie	Format Format	Cod.
558	547	408-558	30 lm	0,6 W	Natural white 4.000 K Naturalna biel 4.000 K	30	Moka painted Malowane na kolor mokka	1 Ut/Szt	5074013
708	697	558-708	35 lm	0,7 W	Natural white 4.000 K Naturalna biel 4.000 K	45	Moka painted Malowane na kolor mokka	1 Ut/Szt	5074113
858	847	708-858	45 lm	0,9 W	Natural white 4.000 K Naturalna biel 4.000 K	60	Moka painted Malowane na kolor mokka	1 Ut/Szt	5074213
1.008	997	858-1.008	50 lm	1 W	Natural white 4.000 K Naturalna biel 4.000 K	75	Moka painted Malowane na kolor mokka	1 Ut/Szt	5074313
1.158	1.147	1.008-1.158	55 lm	1,2 W	Natural white 4.000 K Naturalna biel 4.000 K	90	Moka painted Malowane na kolor mokka	1 Ut/Szt	5074413
558	547	408-558	30 lm	0,6 W	Natural white 4.000 K Naturalna biel 4.000 K	30	Matt anodized Anodyzowany mat	1 Ut/Szt	5074062
708	697	558-708	35 lm	0,7 W	Natural white 4.000 K Naturalna biel 4.000 K	45	Matt anodized Anodyzowany mat	1 Ut/Szt	5074162
858	847	708-858	45 lm	0,9 W	Natural white 4.000 K Naturalna biel 4.000 K	60	Matt anodized Anodyzowany mat	1 Ut/Szt	5074262
1.008	997	858-1.008	50 lm	1 W	Natural white 4.000 K Naturalna biel 4.000 K	75	Matt anodized Anodyzowany mat	1 Ut/Szt	5074362
1.158	1.147	1.008-1.158	55 lm	1,2 W	Natural white 4.000 K Naturalna biel 4.000 K	90	Matt anodized Anodyzowany mat	1 Ut/Szt	5074462

Aluminium, Plastic
Aluminium, Plastik

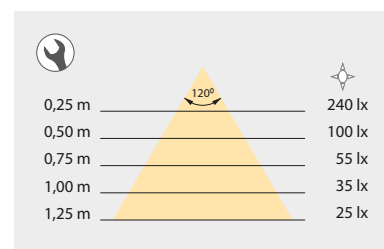
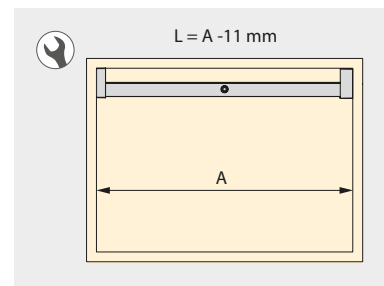
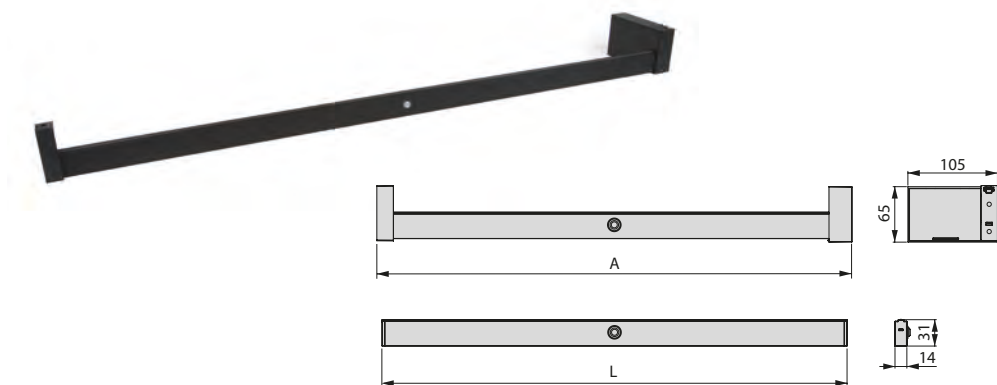

Functioning with an extractable battery, which can recharged using a 5V DC 1A mobile charger with a micro USB type B port.
The cod. 5077413 and 5077462 included the central rail support.

Działa dzięki zasilaniu bateryjnemu, które można doładowywać z wykorzystaniem przenośnej ładowarki na prąd stały 5V 1A z mikroportem USB typu B.
Kod 5077413 i 5077462 zawiera w komplecie wspornik środkowy drążka.



ILLUMINATED HANGING BARS // PODŚWIETLANE DRAŻKI NA WIESZAKI

Polux Hanging wardrobe bar with LED light with motion sensor (12V DC)

Drażek do szafy z oświetleniem LED, czujnik ruchu, Polux (12V DC)

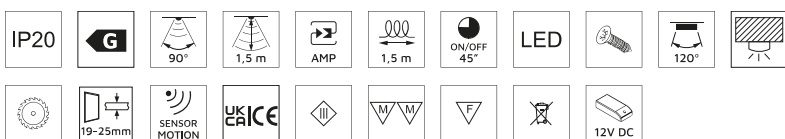
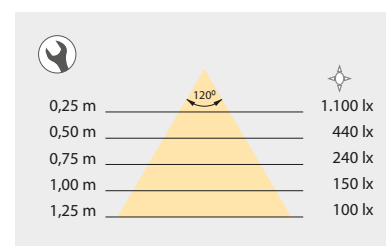
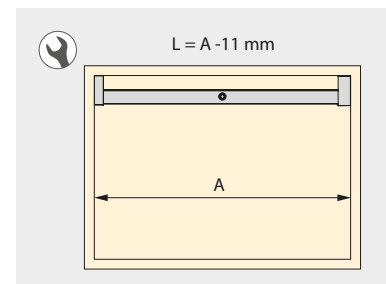
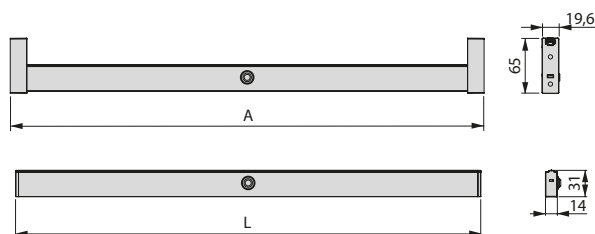

A	L	Cut Obcinane	Lumen	Power Moc	Colour temperature Temperatura koloru	LEDs	Finishing Wykończenie	Format Format	Cod.
558	547	408-558	125 lm	2,6 W	Natural white 4.000 K Naturalna biel 4.000 K	32	Matt anodized Anodyzowany mat	1 Ut/Szt	5074562
708	697	558-708	160 lm	3,3 W	Natural white 4.000 K Naturalna biel 4.000 K	41	Matt anodized Anodyzowany mat	1 Ut/Szt	5074662
858	847	708-858	190 lm	4 W	Natural white 4.000 K Naturalna biel 4.000 K	50	Matt anodized Anodyzowany mat	1 Ut/Szt	5074762
1.008	997	858-1.008	230 lm	4,8 W	Natural white 4.000 K Naturalna biel 4.000 K	59	Matt anodized Anodyzowany mat	1 Ut/Szt	5074862
1.158	1.147	1.008-1.158	260 lm	5,5 W	Natural white 4.000 K Naturalna biel 4.000 K	68	Matt anodized Anodyzowany mat	1 Ut/Szt	5074962

Aluminium, Plastic
Aluminium, Plastik

The cod. 5077962 included the central rail support.
Does not include LED converter.



Kod 5077962 zawiera w komplecie wspornik środkowy drążka.
Nie uwzględnia konwertera LED.



Gemini LED bathroom mirror spotlight (AC 230V 50Hz)

Reflektor LED do lustra łazienkowego Gemini (AC 230V 50Hz)



Lumen	Power Moc	Colour temperature Temperatura koloru	Finishing Wykończenie	Format Format	Cod.
392 lm	6 W	Natural white 4.000 K Naturalna biel 4.000 K	Chrome plated Chromowane	 5 Ut/Szt	5150011
392 lm	6 W	Natural white 4.000 K Naturalna biel 4.000 K	Black painted Malowane na czarno	 5 Ut/Szt	5150014

Aluminium, Plastic
Aluminium, Plastik

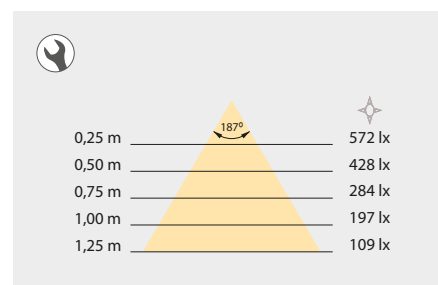
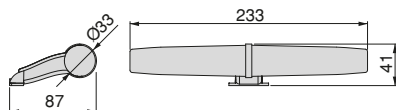

BATHROOM LIGHTS // OŚWIETLЕНИЕ ŁAZIENKOWE

Aries LED bathroom mirror spotlight (AC 230V 50Hz)

Reflektor LED do lustra łazienkowego Aries (AC 230V 50Hz)

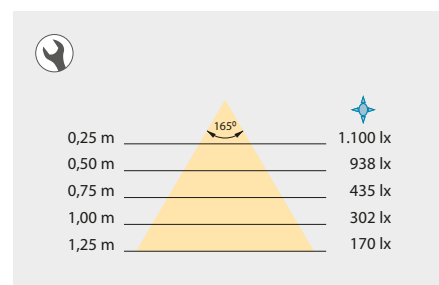
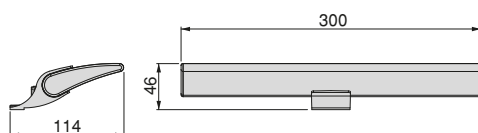

Lumen	Power Moc	Colour temperature Temperatura koloru	Finishing Wykończenie	Format Format	Cod.
599 lm	7 W	Cold white 5.700 K Zimna biel 5.700 K	Chrome plated Chromowane	 5 Ut/Szt	5150211

Aluminium, Plastic
Aluminium, Plastik

BATHROOM LIGHTS // OŚWIETLENIE ŁAZIENKOWE

Leo LED bathroom mirror spotlight (AC 230V 50Hz)

Reflektor LED do lustra łazienkowego Leo (AC 230V 50Hz)



Lumen	Power Moc	Colour temperature Temperatura koloru	LEDs	Finishing Wykończenie	Format Format	Cod.
457 lm	6 W	Cold white 5.700 K Zimna biel 5.700 K	60	Black painted Malowane na czarno	 5 Ut/Szt	5150114

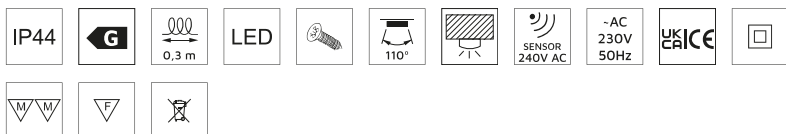
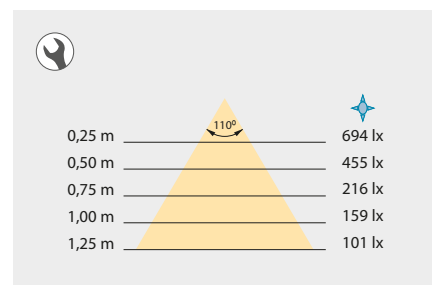
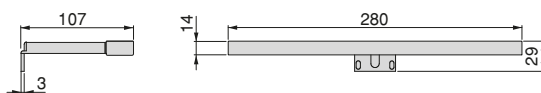

Plastic
Plastik



Aquarius LED lamp over mirror 300 - 450 mm (AC 230V 50Hz)

Kinkiet LED do lustra łazienkowego Aquarius 300 - 450 mm (AC 230V 50Hz)



A	Lumen	Power Moc	Colour temperature Temperatura koloru	LEDs	Finishing Wykończenie	Format Format	Cod.
300	520 lm	7 W	Cold white 6.000 K Zimna biel 6.000 K	60	Chrome plated Chromowane	 5 Ut/Szt	5145311
450	480 lm	7 W	Cold white 6.000 K Zimna biel 6.000 K	60	Chrome plated Chromowane	 5 Ut/Szt	5145411

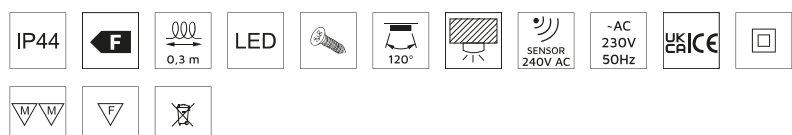
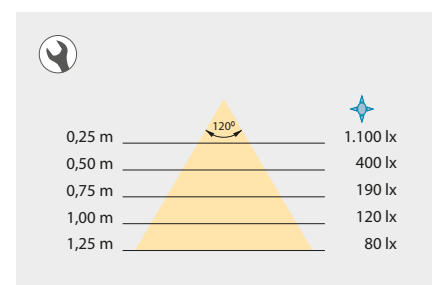
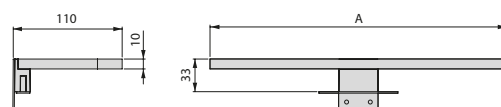

Aluminium, Plastic
Aluminium, Plastik



BATHROOM LIGHTS // OŚWIETLENIE ŁAZIENKOWE

Virgo LED bathroom mirror spotlight (AC 230V 50Hz)

Reflektor LED do lustra łazienkowego Virgo (AC 230V 50Hz)

Lumen	Power Moc	Colour temperature Temperatura koloru	LEDs	Finishing Wykończenie	Format Format	Cod.
400 lm	6 W	Cold white 6.000 K Zimna biel 6.000 K	60	Chrome plated Chromowane	 5 Ut/Szt	5149111
400 lm	6 W	Cold white 6.000 K Zimna biel 6.000 K	60	Black painted Malowane na czarno	 5 Ut/Szt	5149114

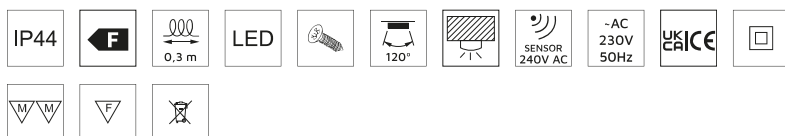
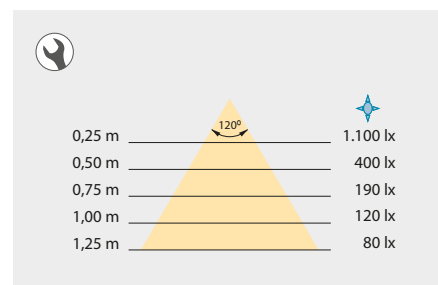
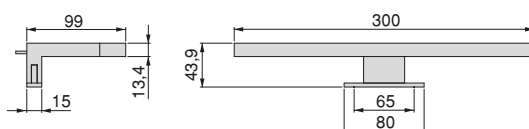
Plastic
Plastik

ILLUMINATED MIRRORS // PODŚWIETLANE LUSTRA

Hercules bathroom mirror with LED front and decorative lighting (AC 230V 50Hz)

Lustro łazienkowe Hercules z oświetleniem LED ozdobnym i z przodu (AC 230V 50Hz)



Lumen	Power Moc	Colour temperature Temperatura koloru	Finishing Wykończenie	Format Format	Cod.
1.728 lm	45 W	Natural white 4.000 K Naturalna biel 4.000 K	Transparent / not defined Przezroczyste / nieokreślone		1 Ut/Szt 5148320

Aluminium, Glass
Aluminium, Szkło

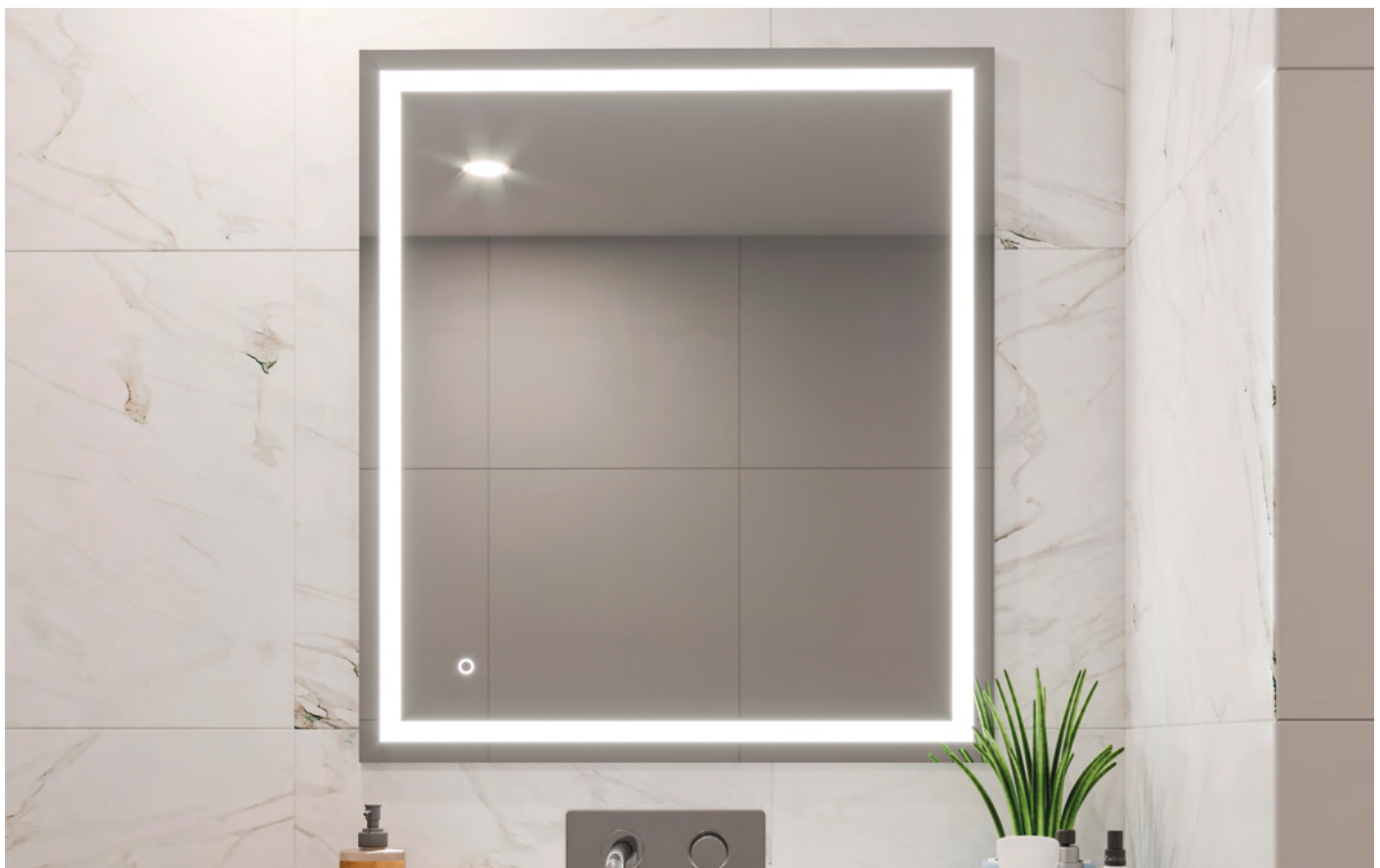
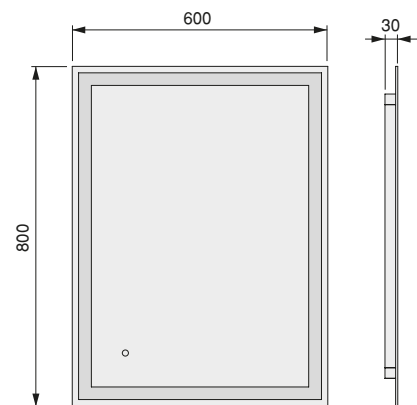



ILLUMINATED MIRRORS // PODŚWIETLANE LUSTRA

Cassiopeia bathroom mirror with LED decorative lighting (AC 230V 50Hz)

Lustro łazienkowe Cassiopeia z ozdobnym oświetleniem LED (AC 230V 50Hz)

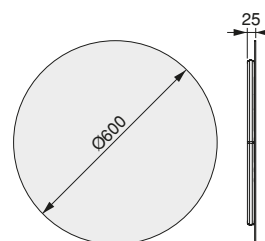

Lumen	Power Moc	Colour temperature Temperatura koloru	Finishing Wykończenie	Format Format	Cod.
718 lm	20 W + 12 W	Natural white 4.000 K Naturalna biel 4.000 K	Transparent / not defined Przezroczyste / nieokreślone		1 Ut/Szt 5148220

Aluminium, Glass
Aluminium, Szkło

ILLUMINATED MIRRORS // PODŚWIETLANE LUSTRA

Pegasus bathroom mirror with LED front lighting (AC 230V 50Hz)

Lustro łazienkowe Pegasus z oświetleniem LED z przodu (AC 230V 50Hz)

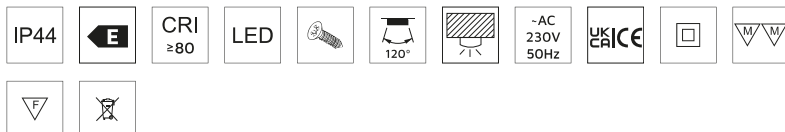
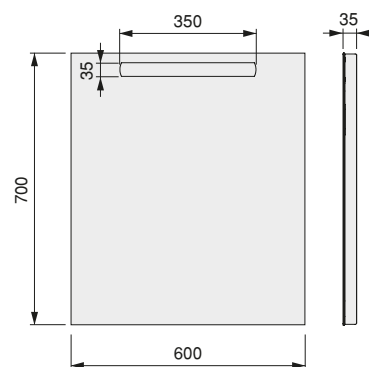

Lumen	Power Moc	Colour temperature Temperatura koloru	Finishing Wykończenie	Format Format	Cod.
414 lm	6 W	Natural white 4.000 K Naturalna biel 4.000 K	Transparent / not defined Przezroczyste / nieokreślone		1 Ut/Szt 5148120

Aluminium, Glass
Aluminium, Szkło

Drawled Battery-powered LED light for inside drawers with vibration sensor and cool light

Oświetlenie LED zasilane bateryjnie do wnętrza szuflad Drawled, czujnik wibracji, zimne światło



Lumen	Power Moc	Colour temperature Temperatura koloru	LEDs	Finishing Wykończenie	Format Format	Cod.
28 lm	0,6 W	Cold white 7.000 K Zimna biel 7.000 K	4	Silver painted Malowane aluminium	5 Ut/Szt	5006325

Plastic
Plastik

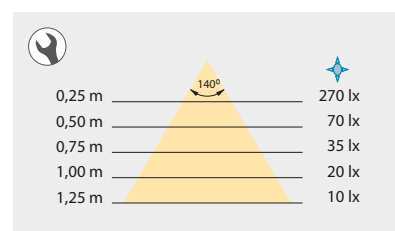
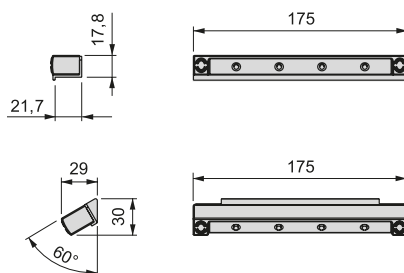

BATTERY OPERATED // Z BATERIĄ

Kraz Rechargeable LED light with movement sensor

Oprawa LED zasilanie akumulatorowe, czujnik ruchu

Lumen	Power Moc	Colour temperature Temperatura koloru	LEDs	Finishing Wykończenie	Format Format	Cod.
85 lm	1 W	Natural white 4.000 K Naturalna biel 4.000 K	9	Silver painted Malowane aluminium	5 Ut/Szt	5028625

Plastic
Plastik

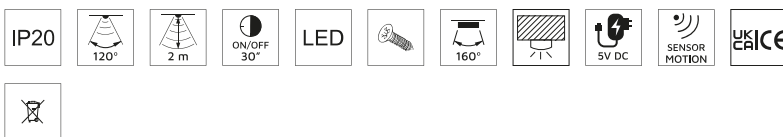
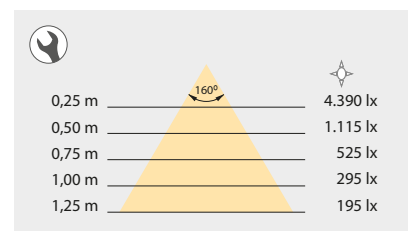
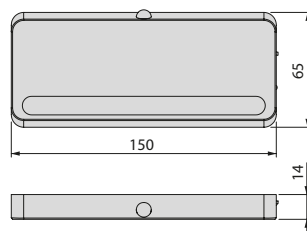

Crater LED light rechargeable by USB and with motion sensor

Kinkiet LED, zasilanie akumulatorowe przez USB, czujnik ruchu, Crater

Lumen	Power Moc	Colour temperature Temperatura koloru	LEDs	Finishing Wykończenie	Format Format	Cod.
110 lm	1 W	Natural white 4.000 K Naturalna biel 4.000 K	28	Silver painted Malowane aluminium	5 Ut/Szt	5023925

Plastic
Plastik

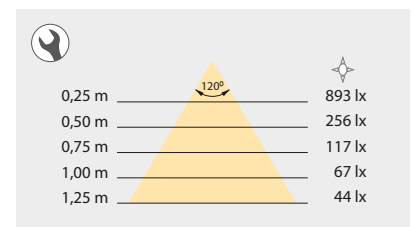
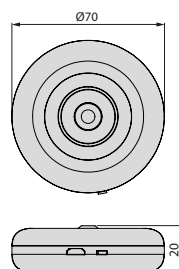

DRIVERS AND DETECTORS KONWERTORY I CZUJNIKI



DRIVERS // KONWERTORY

Constant-voltage converter for LED lights, plastic (12V DC)

Zasilacz napięcia stałego do opraw LED, plastik (12V DC)

A	B	C	Power Moc	Input	Output	Finishing Wykończenie	Format Format	Cod.
17	164	65	30 W	100-240V AC - 50-60Hz 100-240V AC - 50-60Hz	12V DC 12V DC	Transparent / not defined Przezroczyste / nieokreślone	<input type="checkbox"/>	10 Ut/Szt 5147420
17	164	65	50 W	100-240V AC - 50-60Hz 100-240V AC - 50-60Hz	12V DC 12V DC	Transparent / not defined Przezroczyste / nieokreślone	<input type="checkbox"/>	10 Ut/Szt 5147520
38	153	60	72 W	100-240V AC - 50-60Hz 100-240V AC - 50-60Hz	12V DC 12V DC	Transparent / not defined Przezroczyste / nieokreślone	<input type="checkbox"/>	10 Ut/Szt 5008520

Plastic
Plastik

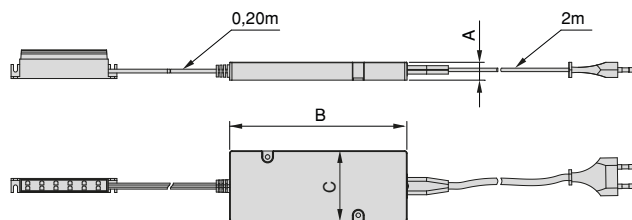

Constant-voltage converter for LED lights, plastic (12V DC)

Zasilacz napięcia stałego do opraw LED, plastik (12V DC)

A	B	C	Power Moc	Input	Output	Finishing Wykończenie	Format Format	Cod.
18	160	58	100 W	100-240V AC - 50-60Hz 100-240V AC - 50-60Hz	12V DC 12V DC	Transparent / not defined Przezroczyste / nieokreślone	<input type="checkbox"/>	5 UN/UN 5209320
35	205	71	200 W	100-240V AC - 50-60Hz 100-240V AC - 50-60Hz	12V DC 12V DC	Transparent / not defined Przezroczyste / nieokreślone	<input type="checkbox"/>	5 UN/UN 5209420

Plastic
Plastik

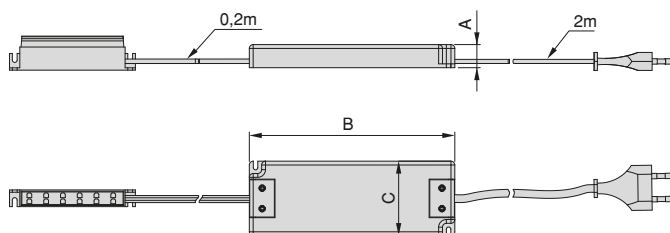

DRIVERS // KONWERTORY

Constant-voltage converter for LED lights, plastic (24V DVC)

Zasilacz napięcia stałego do opraw LED, plastik (24V DVC)

A	B	C	Power Moc	Input	Output	Finishing Wykończenie	Format Format	Cod.
16,2	96	41	15 W	100-240V AC - 50-60Hz 100-240V AC - 50-60Hz	24V DC 24V DC	Transparent / not defined Przezroczyste / nieokreślone	10 UN/UN	5211220
17	164	65	30 W	100-240V AC - 50-60Hz 100-240V AC - 50-60Hz	24V DC 24V DC	Transparent / not defined Przezroczyste / nieokreślone	10 UN/UN	5147620
17	164	65	50 W	100-240V AC - 50-60Hz 100-240V AC - 50-60Hz	24V DC 24V DC	Transparent / not defined Przezroczyste / nieokreślone	10 UN/UN	5147720

Plástico
Plástico

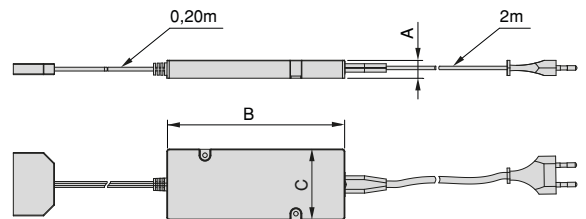

Constant-voltage converter for LED lights, plastic (24V DVC)

Zasilacz napięcia stałego do opraw LED, plastik (24V DVC)

A	B	C	Power Moc	Input	Output	Finishing Wykończenie	Format Format	Cod.
18	160	58	100 W	100-240V AC - 50-60Hz 100-240V AC - 50-60Hz	24V DC 24V DC	Transparent / not defined Przezroczyste / nieokreślone	5 UN/UN	5209520

Plastic
Plastik

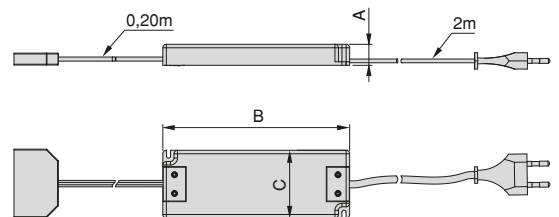

INFORMATION INFORMACJE

SENSORS // CZUJNIKI



Proximity hidden sensor system ON/OFF, switches on or off when action range is interfered. No timer.

Ukryty czujnik zbliżeniowy System WŁĄCZONE/WYŁĄCZONE. Włączniki włączone lub wyłączone w przypadku, gdy zostaje gdy dojdzie do zakłócenia zakresu działania. Bez timera.



Proximity sensor system ON/OFF, switches on or off when action range is interfered. No timer.

System czujnika zbliżeniowego WŁĄCZONE/WYŁĄCZONE. Włączniki włączone lub wyłączone w przypadku, gdy zostaje gdy dojdzie do zakłócenia zakresu działania. Bez timera.



Always ON proximity detection system, switches off when movement is detected within action range. No timer.

System wykrywania zbliżenia zawsze WŁĄCZONY. Włączniki wyłącza się w przypadku wykrycia ruchu w zakresie działania. Bez timera.



Movement detection system, switches on when movement is detected within its action range.

System wykrywania ruchu wyłącza się w przypadku wykrycia ruchu w zakresie działania.



Touch sensor by contact. Adjustable sensitiveness according to need.

Czujnik dotykowy przy dotknięciu. Możliwa do ustawienia czułość według potrzeby.



Radio frequency remote control system with two channels and a timing device for the simultaneous switched off of both channels.

System zdalnego sterowania częstotliwością radiową z dwoma kanałami i urządzeniem odmierającym czas dla jednoczesnego wyłączenia obu kanałów.

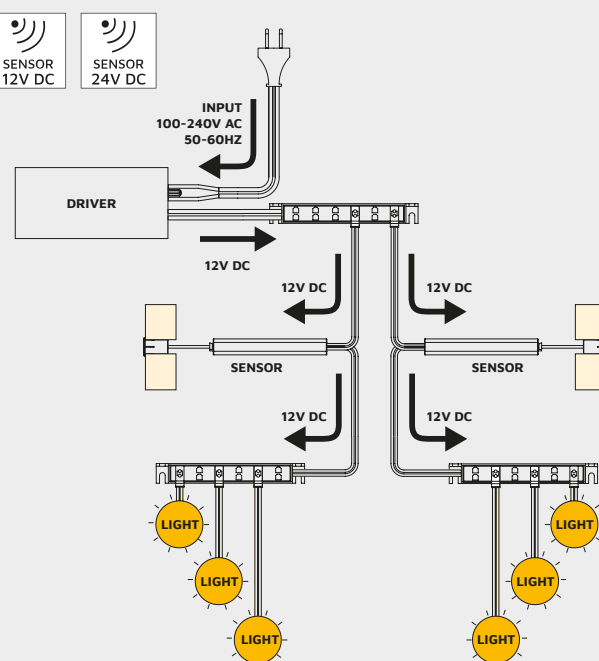
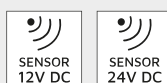
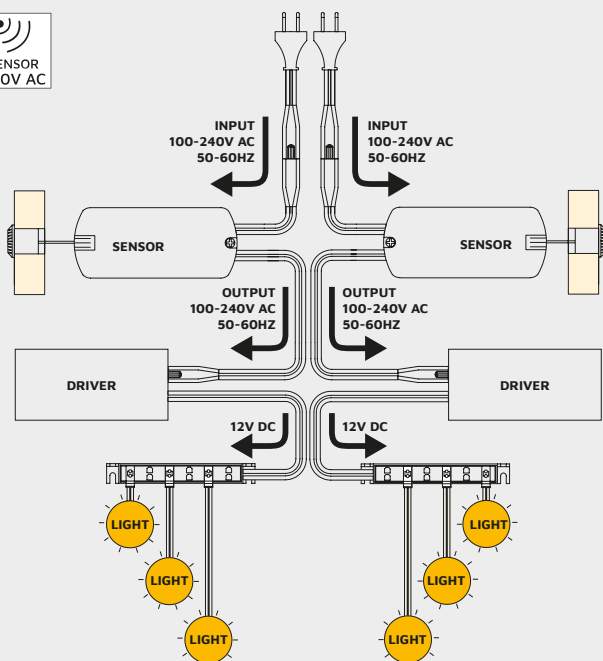
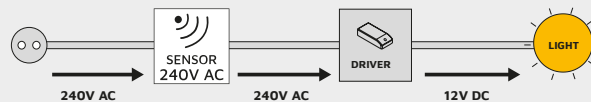
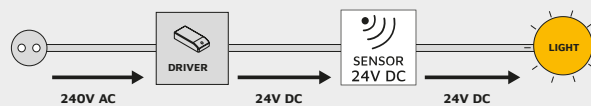
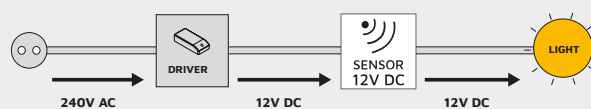
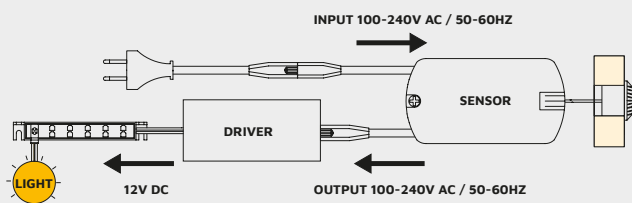

DETECTORS // CZUJNIKI

LED sensor Point switch SIMPLE (switch) 240V AC

Czujnik LED Przełącznik (wyłącznik) punktowy SIMPLE 240V AC



Power Moc	Input	Output	Finishing Wykończenie	Format Format	Cod.
Max. 250 W	100-240V AC 50-60Hz 100-240V AC 50-60Hz	100-240V AC 50-60Hz 100-240V AC 50-60Hz	Silver painted Malowane aluminium		10 Ut/Szt 5040525

Plastic
Plastik

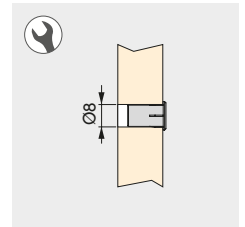
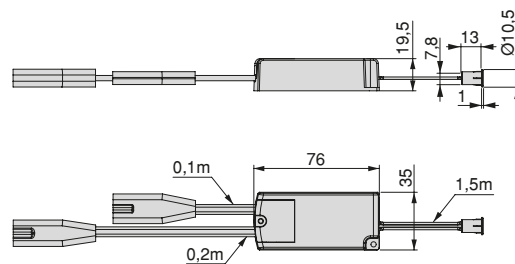

LED sensor Point switch DOUBLE (switch) 240V AC

Czujnik LED Przełącznik (wyłącznik) DOUBLE punktowy 240 V AC



Power Moc	Input	Output	Finishing Wykończenie	Format Format	Cod.
Max. 250 W	100-240V AC 50-60Hz 100-240V AC 50-60Hz	100-240V AC 50-60Hz 100-240V AC 50-60Hz	Silver painted Malowane aluminium		10 Ut/Szt 5040625

Plastic
Plastik

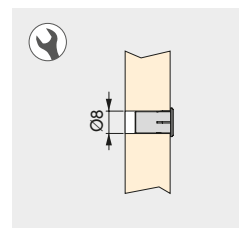
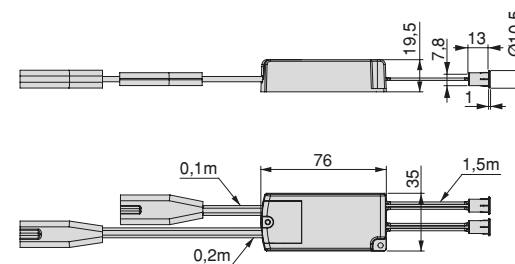

DETECTORS // CZUJNIKI

LED sensor Point door SIMPLE (proximity) 240V AC

Czujnik LED Drzwi punktowe PROSTE (zblizeniowe) 240V AC

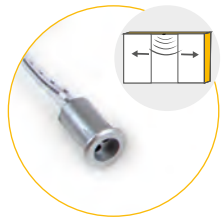

Power Moc	Input	Output	Finishing Wykończenie	Format Format	Cod.
Max. 250 W	100-240V AC 50-60Hz 100-240V AC 50-60Hz	100-240V AC 50-60Hz 100-240V AC 50-60Hz	Silver painted Malowane aluminium	10 Ut/Szt	5040725

Plastic
Plastik

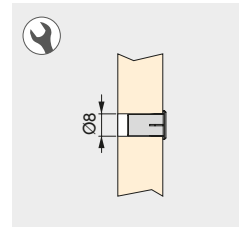
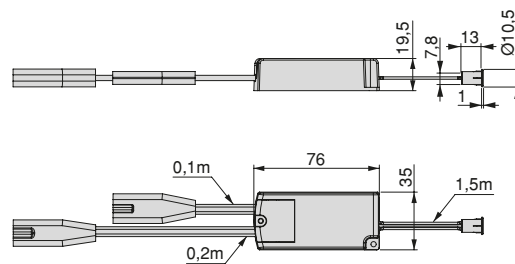

LED sensor Point door DOUBLE (proximity) 240V AC

Czujnik LED Drzwi dwupunktowe (zblizeniowe) 240 V AC

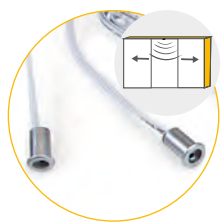

Power Moc	Input	Output	Finishing Wykończenie	Format Format	Cod.
Max. 250 W	100-240V AC 50-60Hz 100-240V AC 50-60Hz	100-240V AC 50-60Hz 100-240V AC 50-60Hz	Silver painted Malowane aluminium	10 Ut/Szt	5040825

Plastic
Plastik

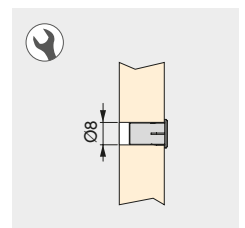
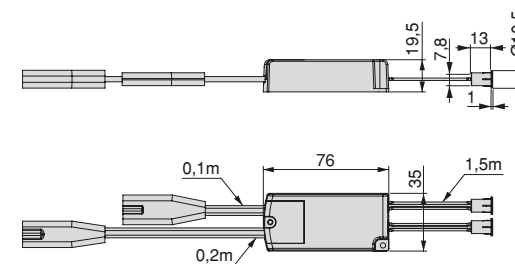

DETECTORS // CZUJNIKI

LED sensor Red Eye 4 motion (movement) 240V AC

Czujnik LED Ruch Red Eye 4



Power Moc	Input	Output	Finishing Wykończenie	Format Format	Cod.
250 W	100-240V AC 50-60Hz 100-240V AC 50-60Hz	100-240V AC 50-60Hz 100-240V AC 50-60Hz	Transparent / not defined Przezroczyste / nieokreślone		10 Ut/Szt 7001820

Plastic
Plastik

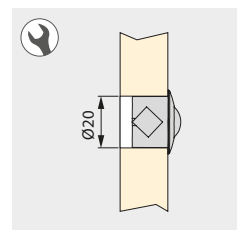
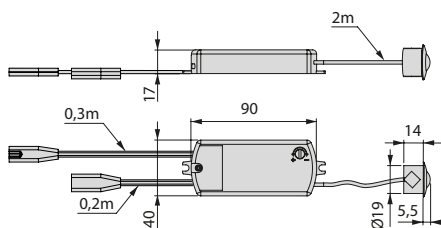

LED sensor Red Eye 5 metal (touch) 240V AC

Czujnik LED Metal (dotykowy) Red Eye 5



Power Moc	Input	Output	Finishing Wykończenie	Format Format	Cod.
500 W	220-240V AC - 50Hz 220-240V AC - 50Hz	220-240V AC 50-60Hz 220-240V AC 50-60Hz	Transparent / not defined Przezroczyste / nieokreślone		10 Ut/Szt 7001920

Plastic
Plastik

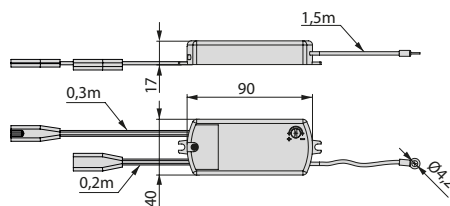

Touch pad and screw

Włącznik/ściemniacz (Włącznik) ukryty czujnik Spirit

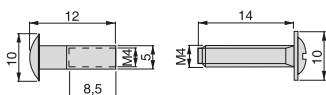

Finishing Wykończenie	Format Format	Cod.
Chrome plated Chromowane	10 Ut/Szt	7006011

Steel
Stal

DETECTORS // CZUJNIKI

LED sensor Point switch SIMPLE (switch) 12V DC / 24V DC

Czujnik LED Włacznik punktowy (Włacznik)



Power Moc	Input	Output	Finishing Wykończenie	Format Format	Cod.
36 W (12V DC) - 72 W (24V DC)	12V DC - 24V DC 12V DC - 24V DC	12V DC - 24V DC 12V DC - 24V DC	Silver painted Malowane aluminium		6 Ut/Szt 5022925

Plastic
Plastik

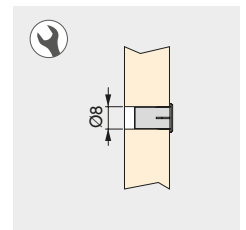
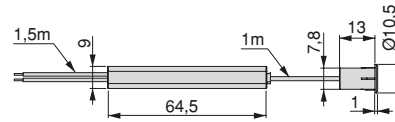

LED sensor Point switch DOUBLE (switch) 12V DC / 24V DC

Czujnik LED Włacznik punktowy (Włacznik)



Power Moc	Input	Output	Finishing Wykończenie	Format Format	Cod.
36 W (12V DC) - 72 W (24V DC)	12V DC - 24V DC 12V DC - 24V DC	12V DC - 24V DC 12V DC - 24V DC	Silver painted Malowane aluminium		6 Ut/Szt 5023025

Plastic
Plastik

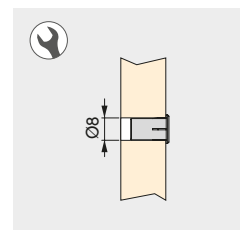
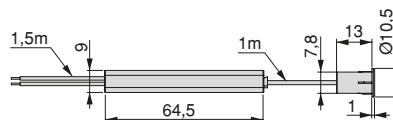

DETECTORS // CZUJNIKI

LED sensor Point door (proximity) 12V DC / 24V DC

Czujnik LED Drzwi Point (zblizeniowy)



Power Moc	Input	Output	Finishing Wykończenie	Format Format	Cod.
36 W (12V DC) - 72 W (24V DC)	12V DC - 24V DC 12V DC - 24V DC	12V DC - 24V DC 12V DC - 24V DC	Silver painted Malowane aluminium		6 Ut/Szt 5023225

Plastic
Plastik

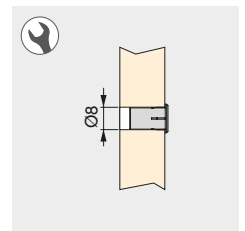
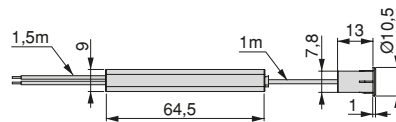

LED sensor Point motion (movement) 12V DC / 24V DC

Czujnik LED Ruch Point



Power Moc	Input	Output	Finishing Wykończenie	Format Format	Cod.
36 W (12V DC) - 72 W (24V DC)	12V DC - 24V DC 12V DC - 24V DC	12V DC - 24V DC 12V DC - 24V DC	Transparent / not defined Przezroczyste / nieokreślone		6 Ut/Szt 5023120

Plastic
Plastik

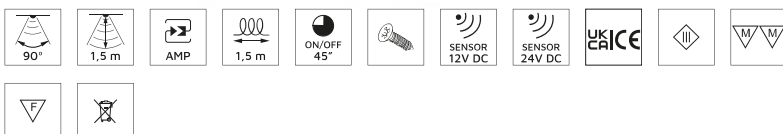
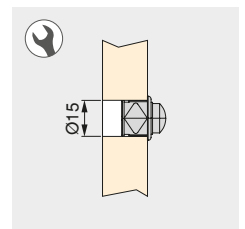
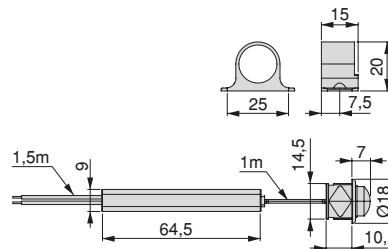

DETECTORS // CZUJNIKI

LED sensor Dot switch/dimmer (switch) 12V DC / 24V DC

Czujnik LED Włącznik/ściemniacz Dot (Włącznik)

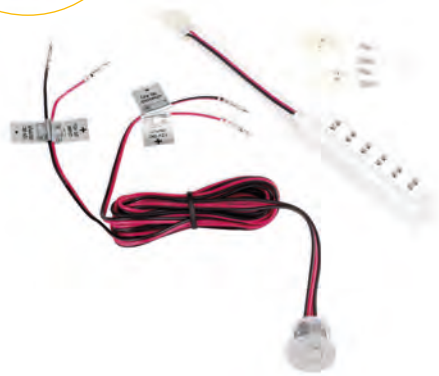
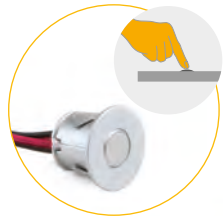

Power Moc	Input	Output	Finishing Wykończenie	Format Format	Cod.
36 W (12V DC) - 72 W (24V DC)	12V DC - 24V DC 12V DC - 24V DC	12V DC - 24V DC 12V DC - 24V DC	Silver painted Malowane aluminium		6 Ut/Szt 5022825

Plastic
Plastik

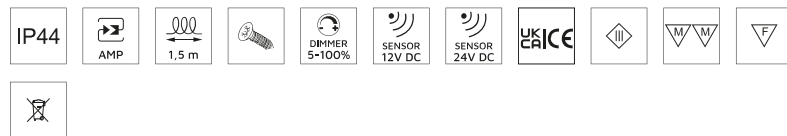
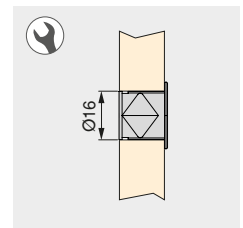
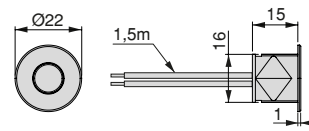

LED sensor Micron switch/dimmer (switch) 12V DC / 24V DC

Czujnik LED Włącznik/ściemniacz Micron (Włącznik)



Power Moc	Input	Output	Finishing Wykończenie	Format Format	Cod.
24 W (12V DC) - 48 W (24V DC)	12V DC - 24V DC 12V DC - 24V DC	12V DC - 24V DC 12V DC - 24V DC	Silver painted Malowane aluminium		6 Ut/Szt 5053125

Plastic
Plastik

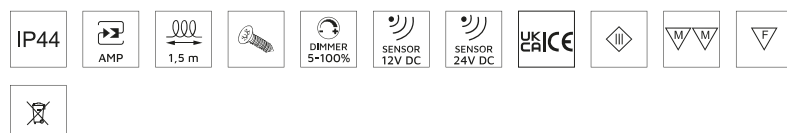
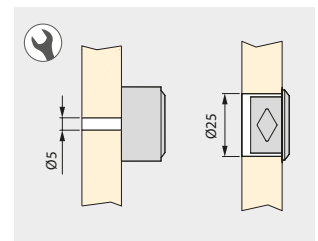
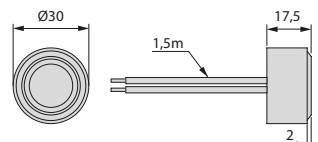

DETECTORS // CZUJNIKI

LED sensor Spirit switch/dimmer (switch) hidden sensor 12V DC

Czujnik LED Włącznik/ściemniacz (Włącznik) ukryty czujnik Spirit

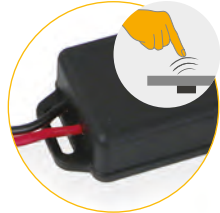

Power Moc	Input	Output	Finishing Wykończenie	Format Format	Cod.
Max. 80 W	12V DC 12V DC	12V DC 12V DC	Black plastic Czarny plastik	6 Ut/Szt	5022617

Plastic
Plastik

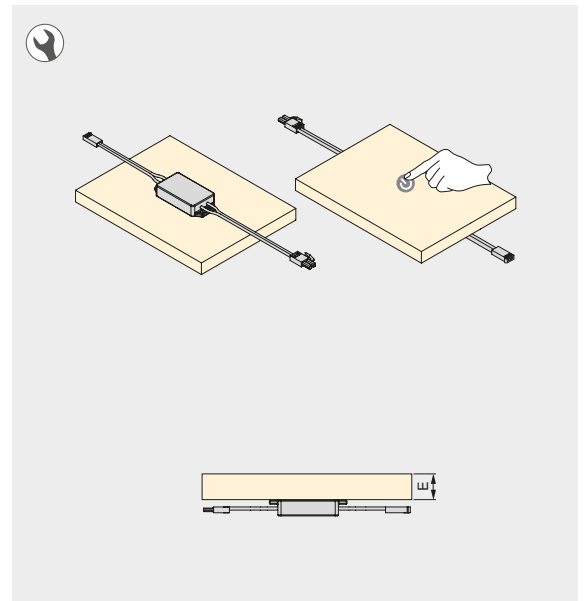
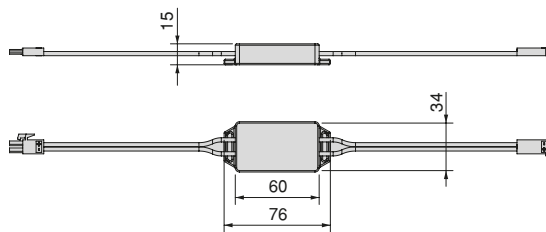

Hidden sensor that penetrates materials of up to 32 mm thick.
Not compatible with mirrors and metals.

Ukryty czujnik przenikający materiały o grubości do 32 mm.
Niekompatybilne z lustrami.

- E < 32 mm Wood.
- E < 22 mm Plastic.
- E < 20 mm Stone.
- E < 12 mm Glass.

- E < 32 mm Drewno.
- E < 22 mm Plastik.
- E < 20 mm Kamień.
- E < 12 mm Kamień.

DETECTORS // CZUJNIKI

LED sensor Wirly switch/dimmer (switch) 12V DC / 24V DC

Czujnik LED Wirtualny przełącznik / ściemniacz (przełącznik) 12V DC / 24V DC



Power Moc	Input	Output	Finishing Wykończenie	Format Format	Cod.
36 W (12V DC) - 72 W (24V DC)	12V DC - 24V DC 12V DC - 24V DC	12V DC - 24V DC 12V DC - 24V DC	Transparent / not defined Przezroczyste / nieokreślone		6 Ut/Szt 5207020

Plastic
Plastik

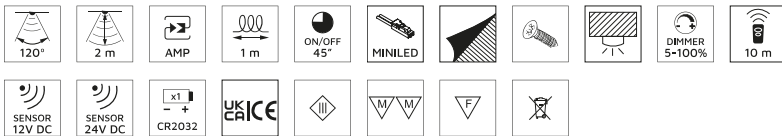
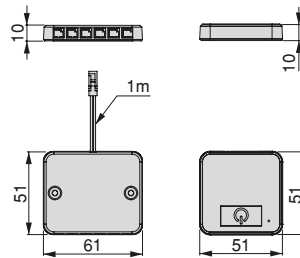

LED sensor Wirly switch/motion (movement) 12V DC / 24V DC

Czujnik LED Wirtualny włącznik / ruch (ruch) 12V DC / 24V DC



Power Moc	Input	Output	Finishing Wykończenie	Format Format	Cod.
36 W (12V DC) - 72 W (24V DC)	12V DC - 24V DC 12V DC - 24V DC	12V DC - 24V DC 12V DC - 24V DC	Transparent / not defined Przezroczyste / nieokreślone		6 Ut/Szt 5207120

Plastic
Plastik

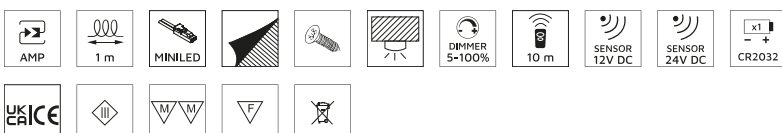
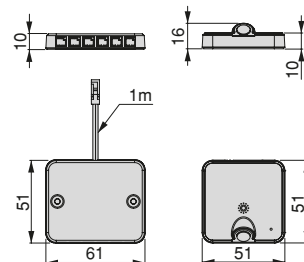

LED LIGHT CONTROLLERS // STEROWNIKI OŚWIETLENIA LED

LED Control for lighting

Sterownik LED do oświetlenia

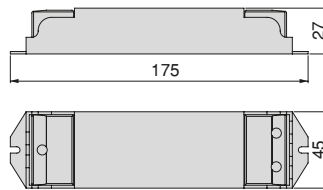

Finishing Wykończenie	Format Format	Cod.
Transparent / not defined Przezroczyste / nieokreślone	1 Ut/Szt	5205920

Plastic
Plastik

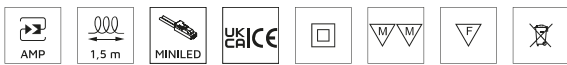

WiFi-Relay for illumination

Moduł Wi-Fi do kontrolera LED do oświetlenia

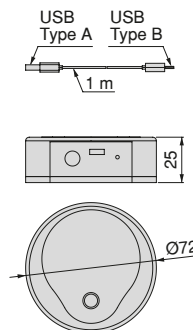

Finishing Wykończenie	Format Format	Cod.
Transparent / not defined Przezroczyste / nieokreślone	1 Ut/Szt	5205820

Plastic
Plastik



LED LIGHT CONTROLLERS // STEROWNIKI OŚWIETLENIA LED

Dimmer Remote Controller for illumination

Pilot Dimmer do oświetlenia



Finishing Wykończenie	Format Format	Cod.
Transparent / not defined Przezroczyste / nieokreślone	1 Ut/Szt	5205720

Plastic
Plastik

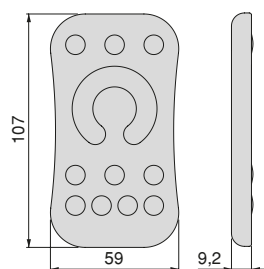

RGB Remote Controller for illumination

Pilot RGB do oświetlenia



Finishing Wykończenie	Format Format	Cod.
Transparent / not defined Przezroczyste / nieokreślone	1 Ut/Szt	5205520

Plastic
Plastik

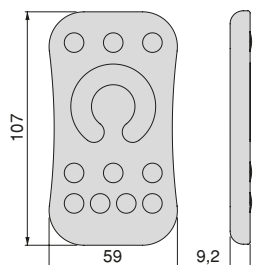

CABLES // KABLE

AMP to Miniled adaptor set for sensors (12V DC) (24V DC)

Zestaw adapterów AMP do MiniLED do czujników (12V DC) (24V DC)

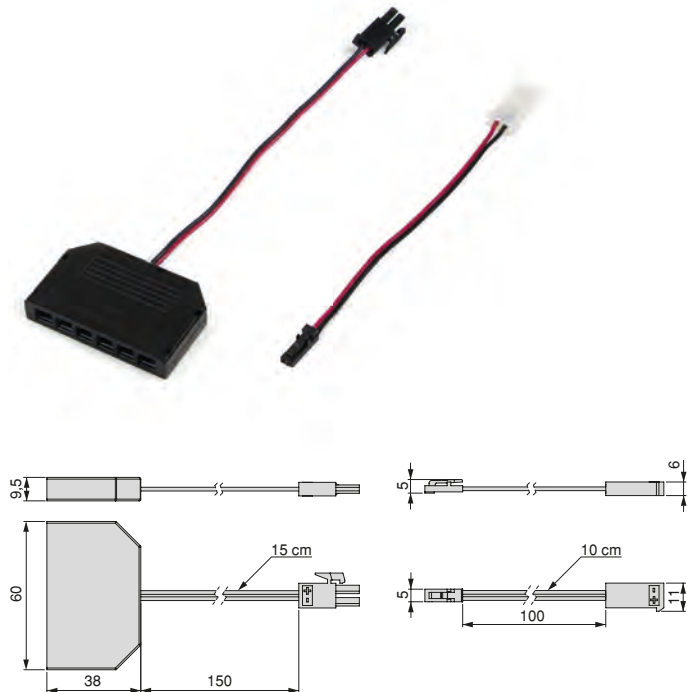

Finishing Wykończenie	Format Format	Cod.
Transparent / not defined Przezroczyste / nieokreślone		10 Ut/Szt 5205020

Plastic
Plastik

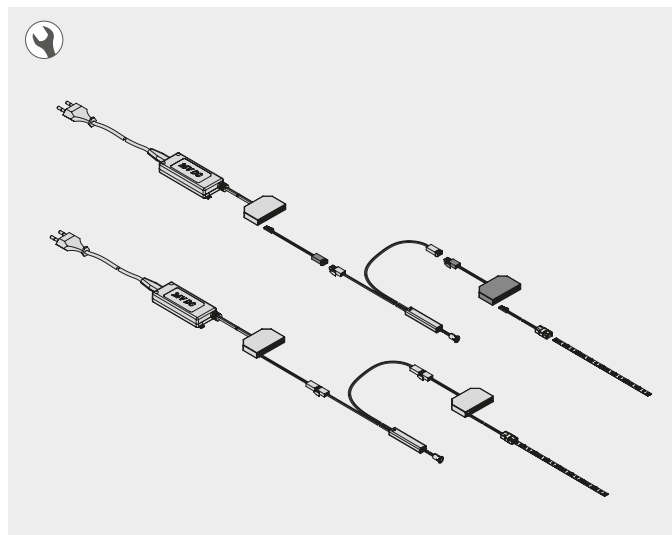

AMP extension cable (12V DC)

Przedłużacz AMP (12V DC)

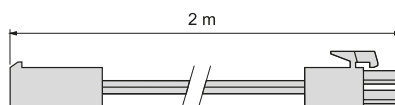

Longitude Długość	Finishing Wykończenie	Format Format
2 m	Black plastic Czarny plastik	25 Ut/Szt

Plastic
Plastik



12V AMP distribution cable

Kabel rozdzielczy 12V AMP

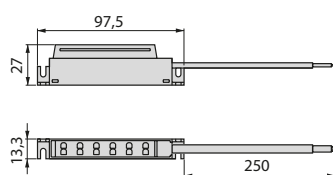

Longitude Długość	Finishing Wykończenie	Format Format
0.25 m	White plastic Biały plastik	10 Ut/Szt

Plastic
Plastik



SWITCHES // PRZEŁĄCZNIKI, WYŁĄCZNIKI

Switch for embedding

Włącznik, montaż wpuszczany

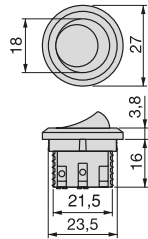

Finishing Wykończenie	Format Format	Cod.
White plastic Biały plastik	100 Ut/Szt	9638115
Black plastic Czarny plastik	100 Ut/Szt	9638117
Grey plastic Szary plastik	100 Ut/Szt	9638121

Plastic
Plastik

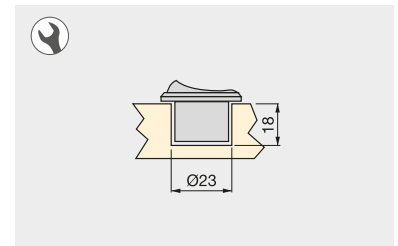

Wardrobe door switch

Przełącznik do drzwi szafy

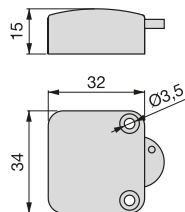

Finishing Wykończenie	Format Format	Cod.
White plastic Biały plastik	10 Ut/Szt	9642415
Black plastic Czarny plastik	10 Ut/Szt	9642417

Plastic
Plastik

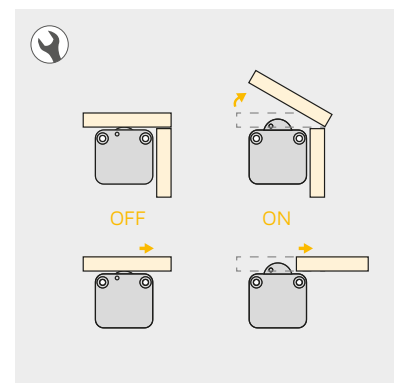

Junction box IP44

Puszka przyłączeniowa IP44

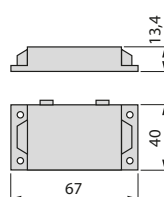

Finishing Wykończenie	Format Format	Cod.
Transparent / not defined Przezroczyste / nieokreślone	20 Ut/Szt	5017220

IP44

OFFICE GABINET



CHARGERS // ŁADOWARKI

Airless wireless hidden charger for mobiles

Bezprzewodowa ładowarka ukryta do telefonów komórkowych Airless

Input	Output	Finishing Wykończenie	Format Format	Cod.
100-240V AC - 50/60Hz 100-240V AC - 50/60Hz	5V DC - 1,8A 5V DC - 1,8A	White plastic Biały plastik	1 Ut/Szt	5149315

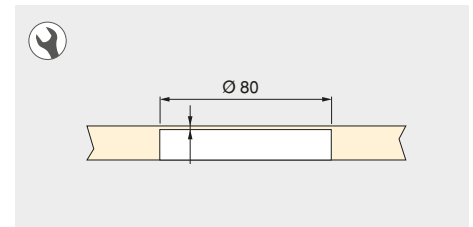
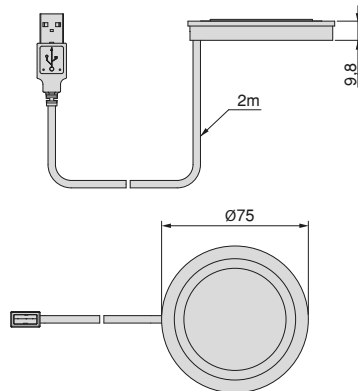
Plastic
Plastik

Airless wireless charger for mobiles

Bezprzewodowa ładowarka do telefonów komórkowych Airless

Input	Output	Finishing Wykończenie	Format Format	Cod.
100-240V AC - 50/60Hz 100-240V AC - 50/60Hz	5V DC - 1,8A 5V DC - 1,8A	White plastic Biały plastik	1 Ut/Szt	5149215

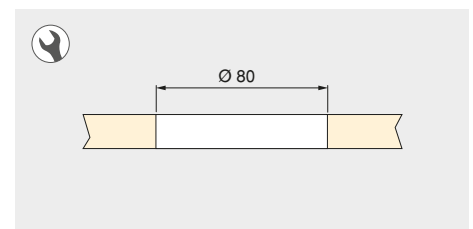
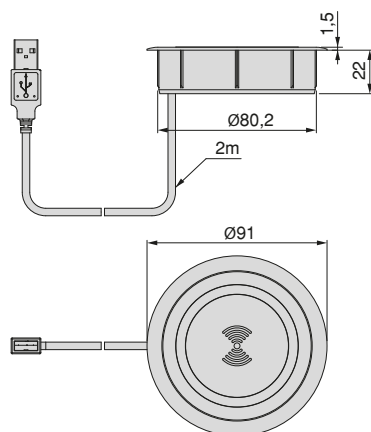
Plastic
Plastik

CONNECTORS // ZŁĄCZA

Connector One for embedding into furniture

Conector One montaż wpuszczany wewnątrz mebla

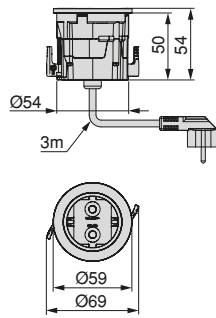

Finishing Wykończenie	Format Format	Cod.
Black painted Malowane na czarno	1 Ut/Szt	5048314

Plastic
Plastik

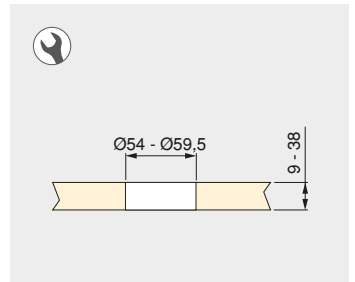

Circle 80 plug connector and grommet

Złącze i przelotka Circle 80

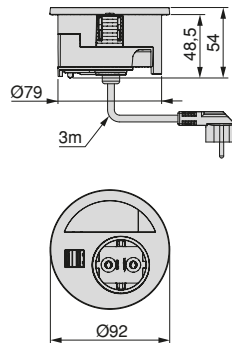

Finishing Wykończenie	Format Format	Cod.
Black painted Malowane na czarno	1 Ut/Szt	5048414

Plastic
Plastik

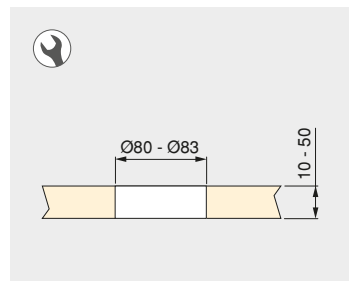

CONNECTORS // ZŁĄCZA

Backflip multi-plug connector for desk

Wielozłącze Backflip na biurko

Finishing Wykończenie	Format Format	Cod.
Stainless steel Stal nierdzewna	1 Ut/Szt	5048565

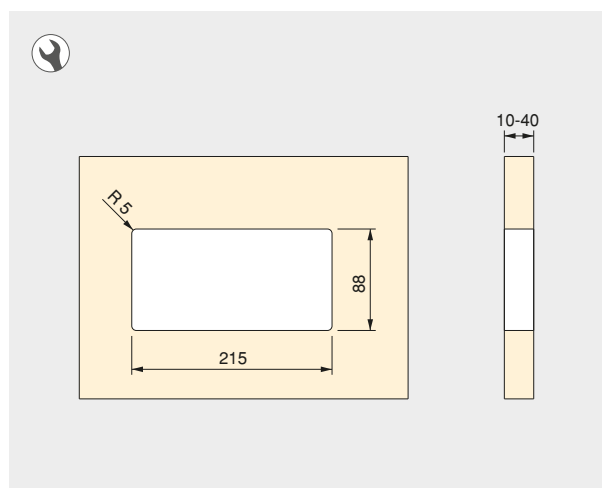
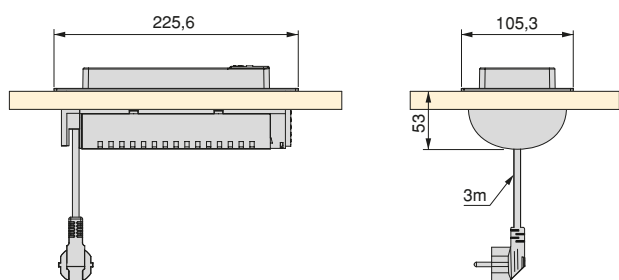
Plastic, Steel
Plastik, Stal

CONNECTORS // ZŁĄCZA

Square 80 plug connector with sliding cover

Listwa zasilająca z gniazdkami Square 80 z przesuwaną pokrywą

Finishing Wykończenie	Format Format	Cod.
Black painted Malowane na czarno	1 Ut/Szt	5048614

Plastic
Plastik

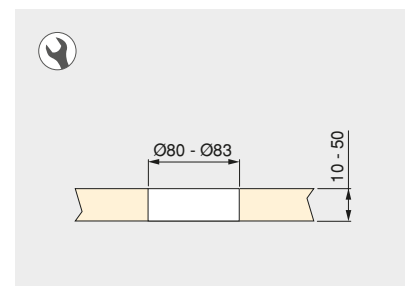
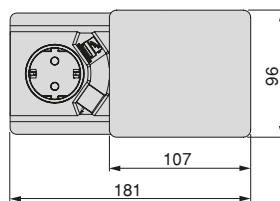
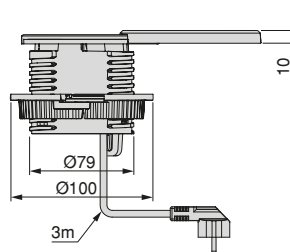

Surface-mounted socket V Dock for furniture

Listwa zasilająca z gniazdkami V Dock do mebli

Finishing Wykończenie	Format Format	Cod.
Matt anodized Anodizowany mat	1 Ut/Szt	5048862

Aluminium, Plastic
Aluminium, Plastik

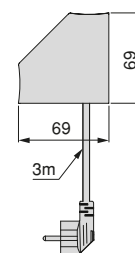
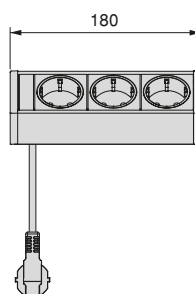

CONNECTORS // ZŁĄCZA

Port USB retractable multi-plug connector

Gniazdowa listwa zasilająca wysuwana Port USB

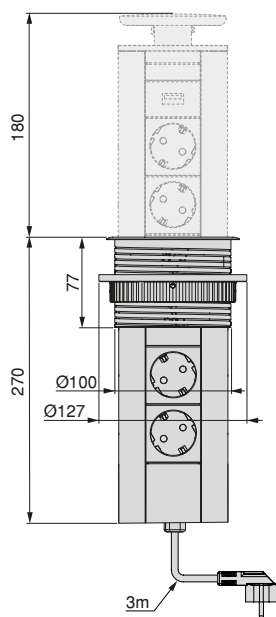

Finishing Wykończenie	Format Format	Cod.
Matt anodized Anodizowany mat	1 Ut/Szt	5048762

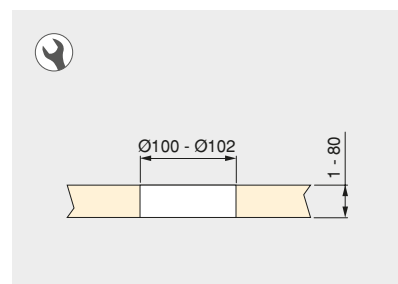
Aluminium, Plastic
Aluminium, Plastik

CONNECTORS // ZŁĄCZA

Atom 26 Multi-plug connector for desk

Wielozłącze Atom 26 na biurko



Description Opis	Finishing Wykończenie	Format Format	Cod.
EU EU	White painted Malowane na biało		1 Ut/Szt 5029512
EU EU	Black painted Malowane na czarno		1 Ut/Szt 5029514
EU EU	Silver painted Malowane aluminium		1 Ut/Szt 5029525

Plastic, Steel, Zamak
Plastik, Stal, Znak

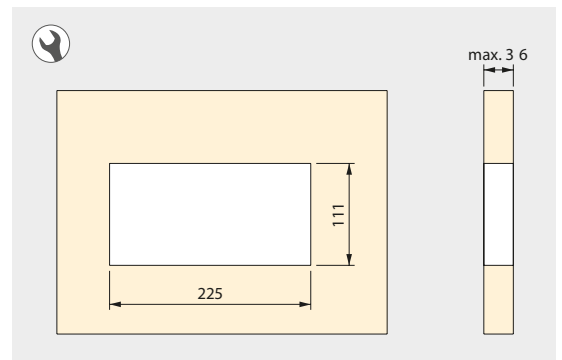
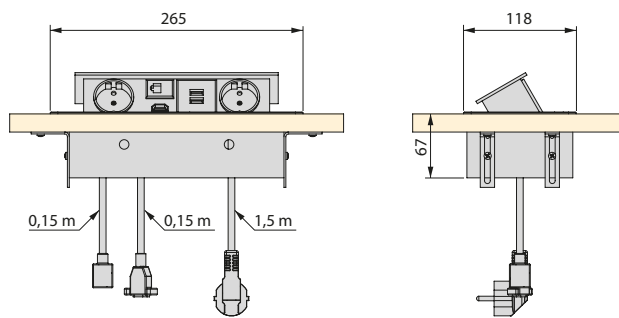
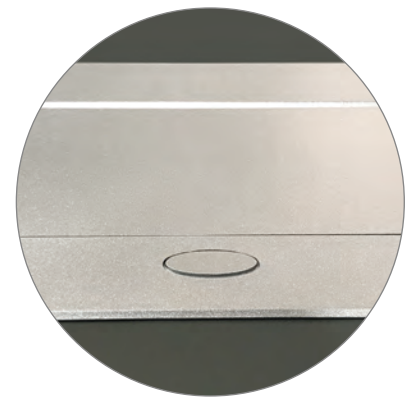

CONNECTORS // ZŁĄCZA

Atom 26 Lite Multi-plug connector for desk

Wielozłącze Atom 26 Lite na biurko

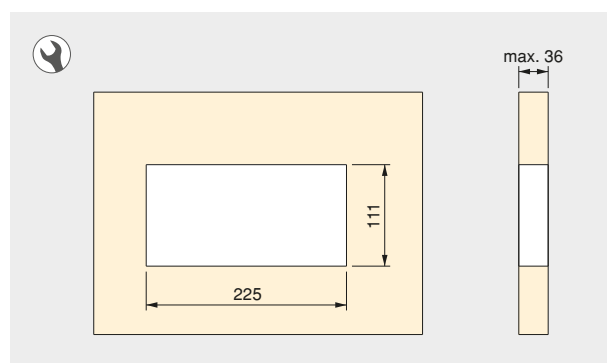
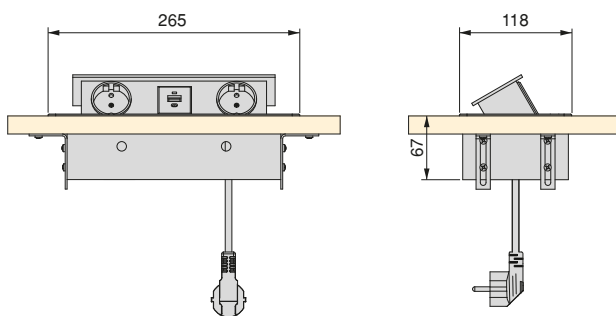

Finishing Wykończenie	Format Format	Cod.
White painted Malowane na biało	1 Ut/Szt	5039812
Black painted Malowane na czarno	1 Ut/Szt	5039814
Silver painted Malowane aluminium	1 Ut/Szt	5039825

Plastic, Steel, Zamak
Plastik, Stal, Znal

CONNECTORS // ZŁĄCZA

Atom 14 Multi-plug connector for desk

Wielozłącze Atom 14 na biurko

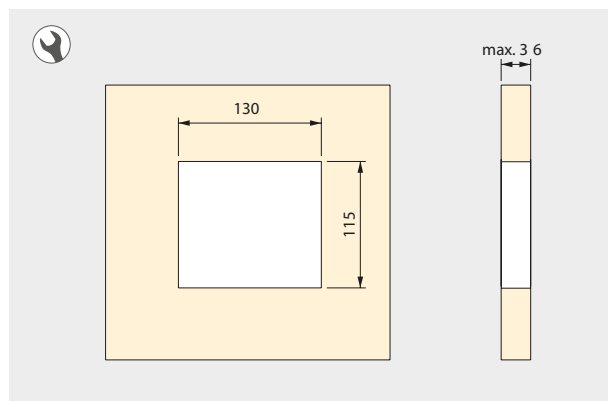
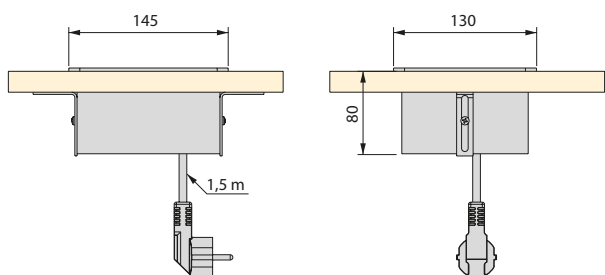
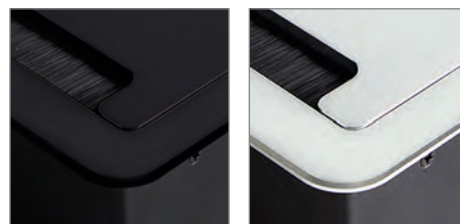

Description Opis	L	Finishing Wykończenie	Format Format	Cod.
EU EU	130	Black painted Malowane na czarno		1 Ut/Szt 5029714
EU EU	130	Silver painted Malowane aluminium		1 Ut/Szt 5029725

Aluminium, Plastic, Steel
Aluminium, Plastik, Stal

CONNECTORS // ZŁĄCZA

Vertikal Flat 60 plug connector with sliding cover

Listwa zasilająca z gździadkiem Flat 60 z przesuwaną pokrywą

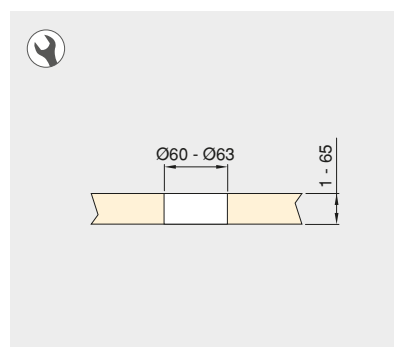
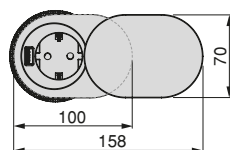
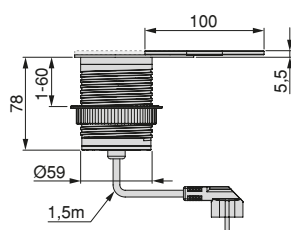

Finishing Wykończenie	Format Format	Cod.
Stainless steel Stal nierdzewna	1 Ut/Szt	5048065

Plastic, Steel
Plastik, Stal

CONNECTORS // ZŁĄCZA

Vertikal retractable multi-plug connector

Gniazdowa listwa zasilająca wysuwana Vertikal

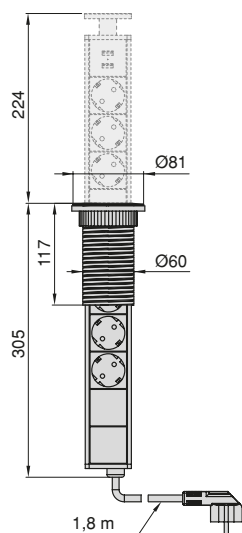

Finishing Wykończenie	Format Format	Cod.
White painted Malowane na biało	1 Ut/Szt	5009912
Silver painted Malowane aluminium	1 Ut/Szt	5009925
Black painted Malowane na czarno	1 Ut/Szt	5009914

Aluminium, Plastic
Aluminium, Plastik

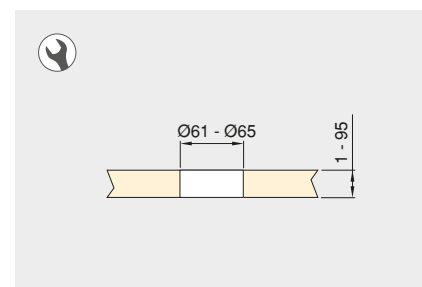

CONNECTORS // ZŁĄCZA

Vertikal Push 60 plug connector

Listwa zasilająca z gniaздkami Vertikal Push 60

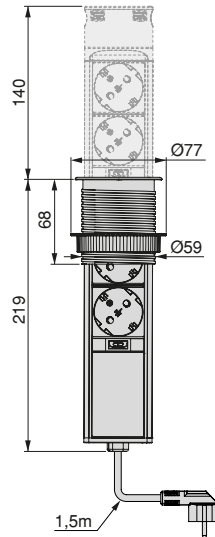

Finishing Wykończenie	Format Format	Cod.
Stainless steel Stal nierdzewna	1 Ut/Szt	5048165

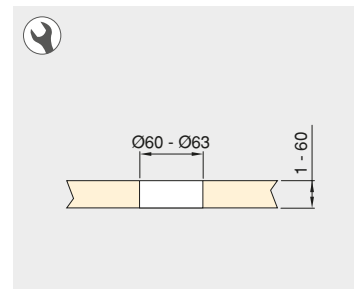
Plastic, Steel
Plastik, Stal

Vertikal Push 100 plug connector

Listwa zasilająca z gniaздkami Vertikal Push 100

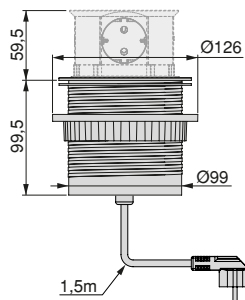

Finishing Wykończenie	Format Format	Cod.
Black painted Malowane na czarno	1 Ut/Szt	5048214

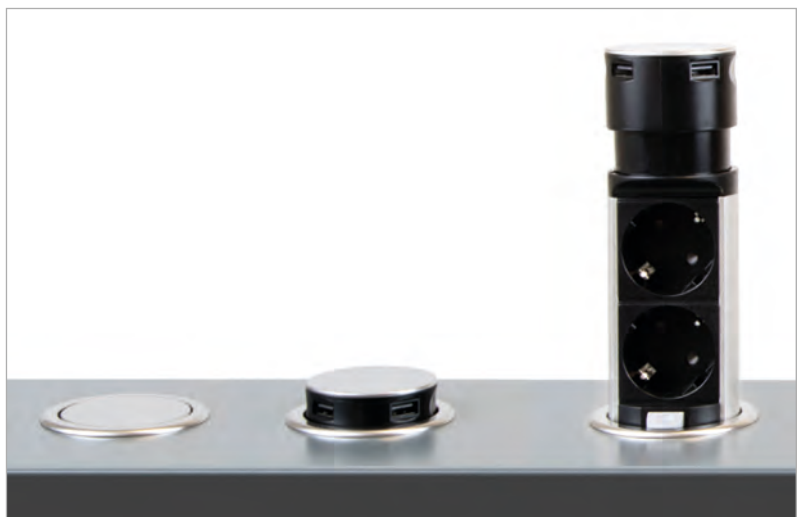
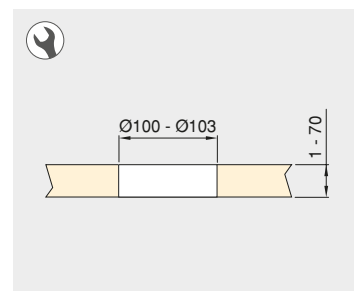
Plastic, Steel
Plastik, Stal

CONNECTORS // ZŁĄCZA

USB Plugs Ø37 round connector

Plugs



Description Opis	Input	Output	Finishing Wykończenie	Format Format	Cod.
Ø37 Ø37	12V DC 12V DC	5V DC 5V DC	Black painted Malowane na czarno		6 Ut/Szt 5009014
Ø37 Ø37	12V DC 12V DC	5V DC 5V DC	Silver painted Malowane aluminium		6 Ut/Szt 5009025

Plastic
Plastik

	Input	Output
	30 W 12V DC (2,50A)	5V DC - 3,40A MAX. (1 x 3,40A) (2 x 1,70A)
	15 W 12V DC (1,25A)	5V DC - 1,70A MAX. (1 x 1,70A) (2 x 0,85A)

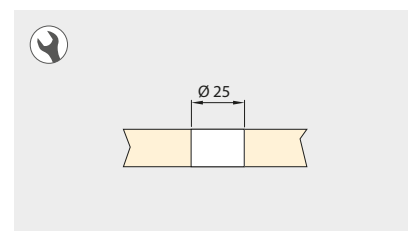
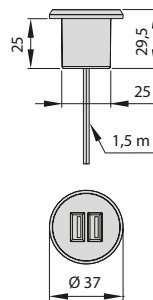

Plug Round connector with 2 USB ports for embedding into furniture

Ladownarka 2x USB wpuszczana w płytę meblową. Plugs



Description Opis	Finishing Wykończenie	Format Format	Cod.
Ø37 Ø37	Black painted Malowane na czarno		1 KIT/Zestaw 5070614
Ø37 Ø37	Silver painted Malowane aluminium		1 KIT/Zestaw 5070625

Plastic
Plastik

CONNECTORS // ZŁĄCZA

USB Plugy square 37x37 connector

Plugy



Description Opis	Input	Output	Finishing Wykończenie	Format Format	Cod.	
37x37 37x37	12V DC 12V DC	5V DC 5V DC	Silver painted Malowane aluminium		6 Ut/Szt	5009125

Plastic
Plastik

	Input	Output
	30 W 12V DC (2,50A)	5V DC - 3,40A MAX. (1 x 3,40A) (2 x 1,70A)
	15 W 12V DC (1,25A)	5V DC - 1,70A MAX. (1 x 1,70A) (2 x 0,85A)

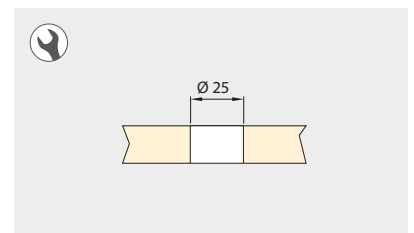
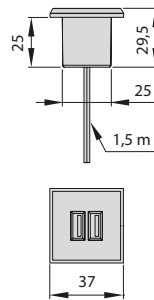

Plugy Square connector with 2 USB ports for embedding into furniture

Złącze kwadratowe, montaż wpuszczany wewnątrz mebla, 2 USB, Plugy



Description Opis	Finishing Wykończenie	Format Format	Cod.
37x37 37x37	Silver painted Malowane aluminium		1 KIT/Zestaw

Plastic
Plastik

CABLE PROFILE // PRZEPUSTY KABLOWE

Quadrum desk cable grommet, rectangular

Przepust kablowy stołowy Quadrum, prostokątny

A	B	Finishing Wykończenie	Format Format	Cod.
159	147	Matt anodized Anodyzowany mat	5 Ut/Szt	5010062
269	257	Matt anodized Anodyzowany mat	5 Ut/Szt	5012462

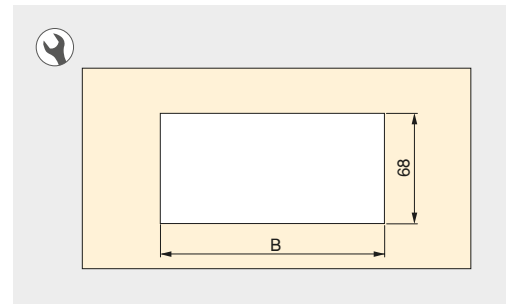
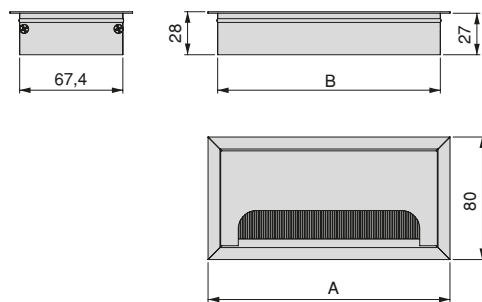
Aluminium
Aluminium

CABLE PROFILE // PRZEPUSTY KABLOWE

Plaswire 85 desk cable grommet

Przepust kablowy stołowy Plaswire 85

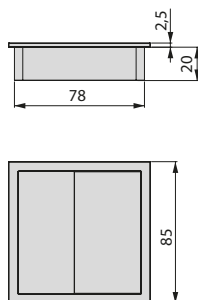

Finishing Wykończenie	Format Format	Cod.
White painted Malowane na biało	15 Ut/Szt	5012512
Black painted Malowane na czarno	15 Ut/Szt	5012514

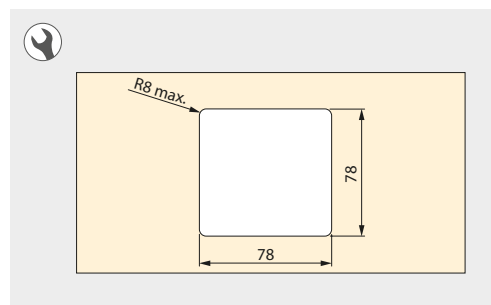
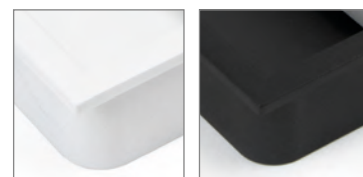
Plastic
Plastik

Plaswire 152 desk cable grommet

Przepust kablowy stołowy Plaswire 152

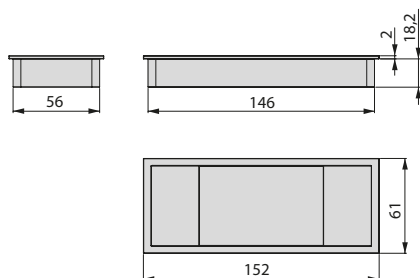

Finishing Wykończenie	Format Format	Cod.
White painted Malowane na biało	10 Ut/Szt	5012612
Black painted Malowane na czarno	10 Ut/Szt	5012614

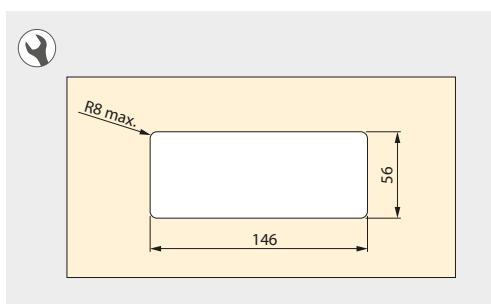
Plastic, Steel
Plastik, Stal

CABLE PROFILE // PRZEPUSTY KABLOWE

Plasquare 1 desk cable grommet

Przepust kablowy stołowy Plasquare 1

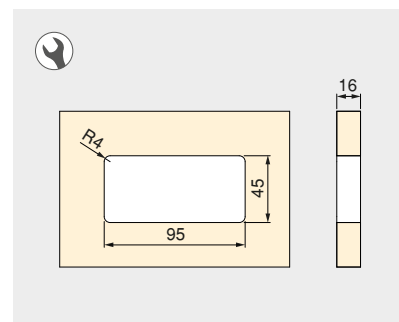
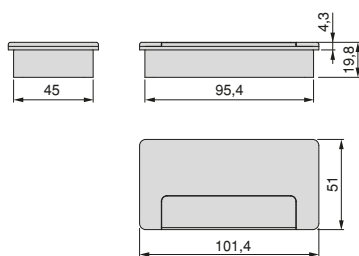

Finishing Wykończenie	Format Format	Cod.
Black plastic Czarny plastik	5 Ut/Szt	3920017
White plastic Biały plastik	5 Ut/Szt	3920015

Plastic
Plastik

CABLE PROFILE // PRZEPUSTY KABLOWE

Plasquare 2 desk cable grommet

Przepust kablowy stołowy Plasquare 2

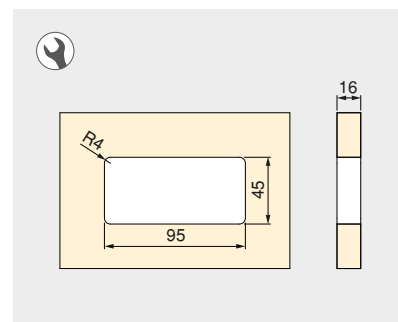
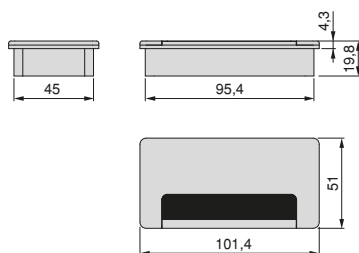

Finishing Wykończenie	Format Format	Cod.
Black plastic Czarny plastik	5 Ut/Szt	3920117
White plastic Biały plastik	5 Ut/Szt	3920115

Plastic
Plastik

CABLE PROFILE // PRZEPUSTY KABLOWE

Plastwin table grommet

Przepust do kabli Plastwin do stołu

Finishing Wykończenie	Format Format	Cod.
White plastic Biały plastik	6 Ut/Szt	3920415
Black plastic Czarny plastik	6 Ut/Szt	3920417

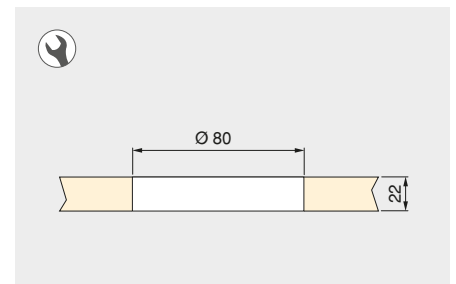
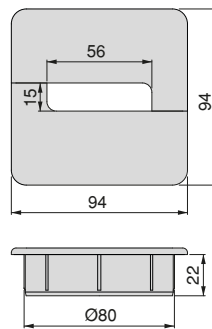
Plastic
Plastik

CABLE PROFILE // PRZEPUSTY KABLOWE

Circum round cable grommet

Przepust kablowy okrągły Circum





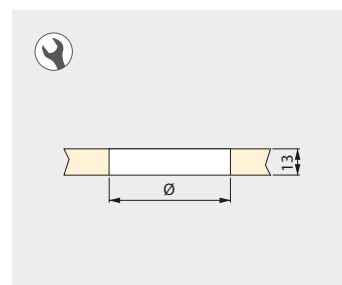
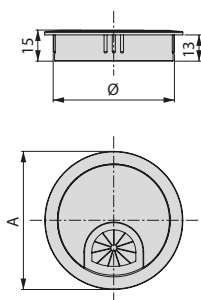

A	Diametre Średnica	Finishing Wykończenie	Format Format	Cod.
68,5	60	Chrome plated Chromowane	8 Ut/Szt	5006711
90	80	Chrome plated Chromowane	7 Ut/Szt	5022511
68,5	60	Matt chrome plated Chromowane matowe	8 Ut/Szt	5006764
90	80	Matt chrome plated Chromowane matowe	7 Ut/Szt	5022564

Zamak
Znal

CABLE PROFILE // PRZEPUSTY KABLOWE

Circular cable organizer

Kołowy organizator kabli

A	B	Diametre Średnica	Finishing Wykończenie	Format Format	Cod.
71	14	60	White plastic Biały plastik		100 Ut/Szt 5123815
71	14	60	Black plastic Czarny plastik		100 Ut/Szt 5123817
95	20	80	Black plastic Czarny plastik		100 Ut/Szt 5123917
71	14	60	Grey plastic Szary plastik		100 Ut/Szt 5123821
95	20	80	Grey plastic Szary plastik		100 Ut/Szt 5123921

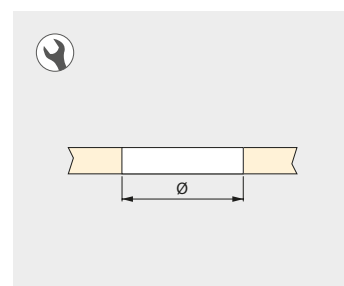
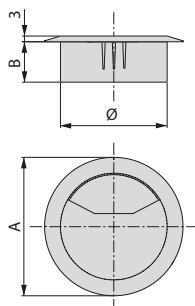
Plastic
Plastik

CABLE PROFILE // PRZEPUSTY KABLOWE

Roundot desk cable grommet

Przepust kablowy stołowy Roundot

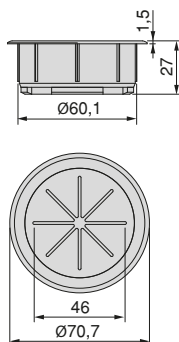

Finishing Wykończenie	Format Format	Cod.
Black plastic Czarny plastik	10 Ut/Szt	3920217

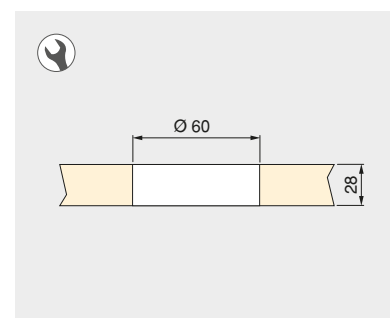
Plastic
Plastik

Pipe 4 Cable grommet column

Kręgołupy kablowe Pipe 4

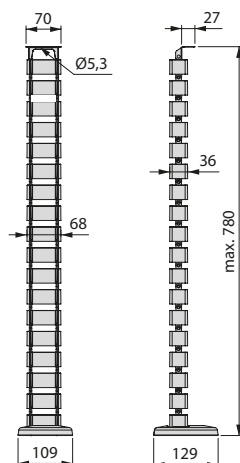

Finishing Wykończenie	Format Format	Cod.
Silver painted Malowane aluminium	10 Ut/Szt	6210025

Plastic
Plastik

ACCESSORIES // AKCESORIA

E-Fan air freshener

E-Fan odświeżacz powietrza

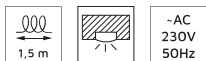
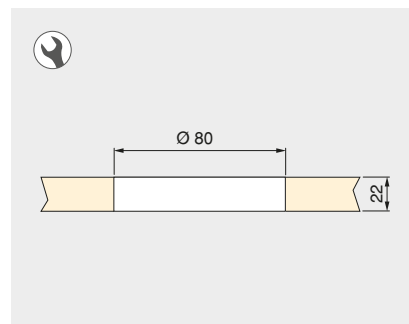
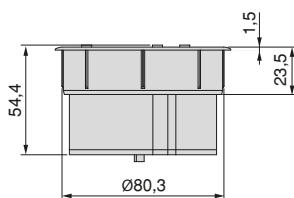

Diametre Średnica	Finishing Wykończenie	Format For- mat	Cod.
80	White plastic Biały plastik	1 Ut/ Szt	5149415

Plastic
Plastik

ACCESSORIES // AKCESORIA

Replacement tablet for E-Fan air freshener

Zaprawy tablet do odświeżacza powietrza E-Fan



Description Opis	Finishing Wykończenie	Format Format	Cod.
lavender lawenda	Transparent / not defined Przezroczyste / nieokreślone	<input type="checkbox"/>	1 Ut/Szt 5149720
citric cytrynowy	Transparent / not defined Przezroczyste / nieokreślone	<input type="checkbox"/>	1 Ut/Szt 5149520

Felt
Filc

Replacement felt for E-Fan air freshener

Zaprawy filc do odświeżacza E-Fan



Finishing Wykończenie	Format Format	Cod.
Transparent / not defined Przezroczyste / nieokreślone	<input type="checkbox"/>	1 Ut/Szt 5149620

Felt
Filc

ACCESSORIES // AKCESORIA

Pot items holder accessory

Dodatek do przechowywania Pot

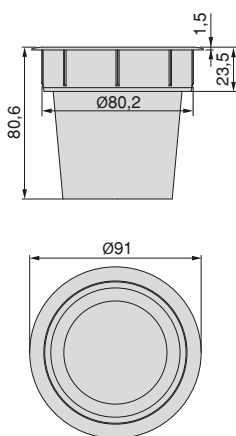

Finishing Wykończenie	Format Format	Cod.
Black plastic Czarny plastik	5 Ut/Szt	3920317
White plastic Biały plastik	5 Ut/Szt	3920315

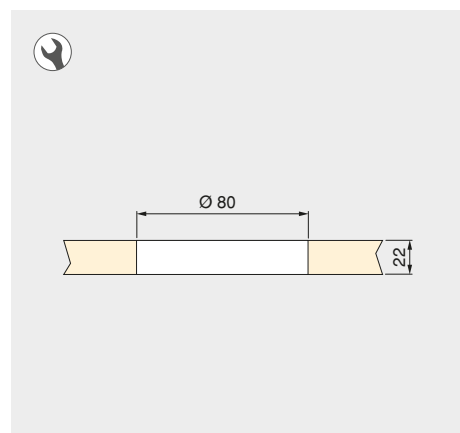
Plastic
Plastik

TV SUPPORTS // WSPORNIKI NA TELEWIZORY

Tilting and rotating 360 ° desk monitor stands for table.

uchwyty na monitor na biurko, uchylny i obrotowy o 360 °.

Description Opis	Finishing Wykończenie	Format Format	Cod.
Simple Proste	Black painted Malowane na czarno	1 Ut/Szt	3200014
Double Podwójne	Black painted Malowane na czarno	1 Ut/Szt	3200114

Steel
Stal

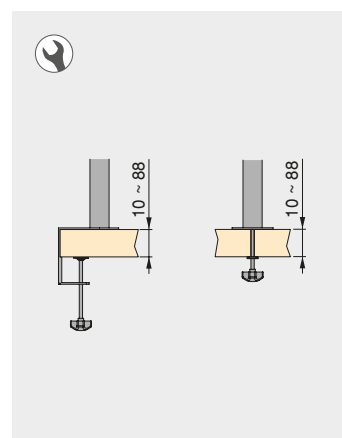
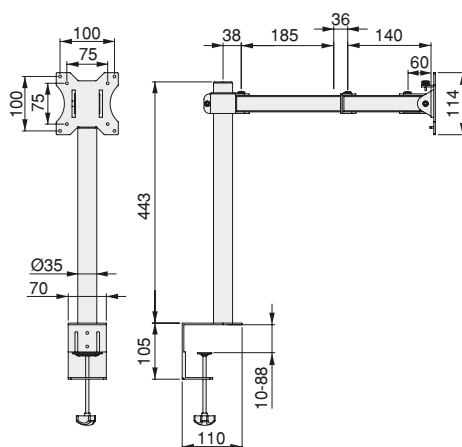

TV SUPPORTS // WSPORNIKI NA TELEWIZORY

Automatic TV stand Lift - Vision

Uchwyt do telewizora Lift - Vision

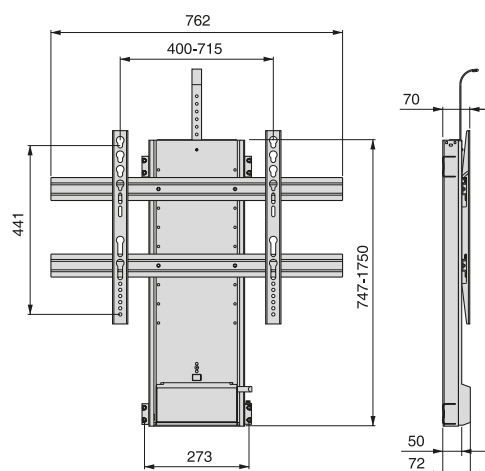

Finishing Wykończenie	Format Format	Cod.
Black painted Malowane na czarno	1 Ut/Szt	6009814

Steel
Stal

- Motorized lifting support for televisions.
- Route of the support until a meter.
- Has a manual switch which can be set into the cabinet, and a radio operated remote control.
- It requires an electrical supply of 110-240 VAC / 50-60Hz.
- Includes a type G adapter (UK).
- A push-back safety mechanism is in place to avoid anything getting caught as the television is lowered.
- End of adjustable race in the slope.
- Loads from 5kg minimum through to 100 kg maximum.
- Compatible with televisions VESA: 200x100 - 200x200 - 300x300 - 400x100 - 400x200 - 400x400 - 600x100 - 600x200 - 600x400.

- Wspornik podnoszący z silnikiem dla telewizorów.
- Wysuw wspornika nawet do 1 metra.
- Wyposażona w ręczny wyłącznik, który można umieścić w szafce, zdalne sterowanie radiowe.
- Wymaga zasilania 110-240 VAC / 50-60Hz.
- W zestawie adapter typu G (UK).
- Zainstalowany zabezpieczający mechanizm odbijający, aby zapobiec zaklinowaniu przy obniżaniu telewizora.
- Zakończenie nastawnej bieżni w nachyleniu.
- Obsługuje obciążenia: minimum 5 kg i maksimum 100 kg.
- Kompatybilne z telewizorami VESA: 200x100 - 200x200 - 300x300 - 400x100 - 400x200 - 400x400 - 600x100 - 600x200 - 600x400.

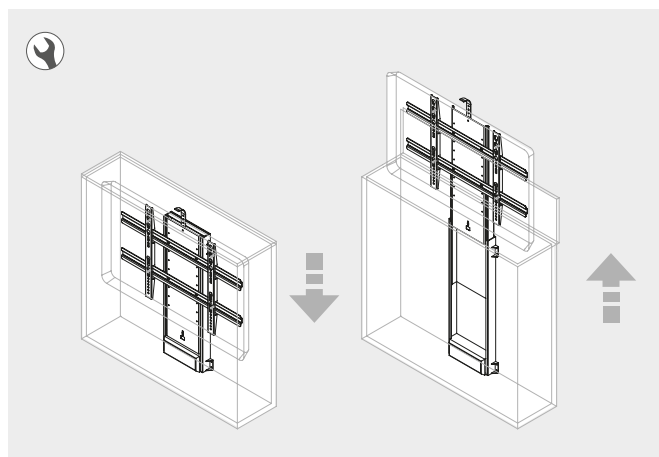

TV SUPPORTS // WSPORNIKI NA TELEWIZORY

Tilting and rotating wall mount for television.

ścienny na telewizor, uchylny i obrotowy, marki Emuca.

Finishing Wykończenie	Format Format	Cod.
Black painted Malowane na czarno	1 Pair/Kpl.	4014314

Steel
Stal

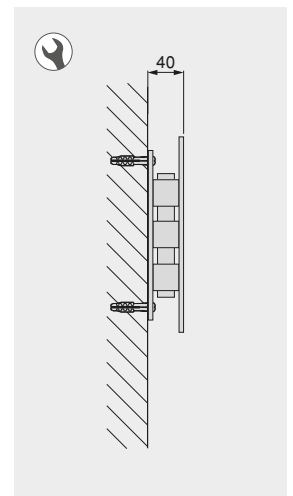
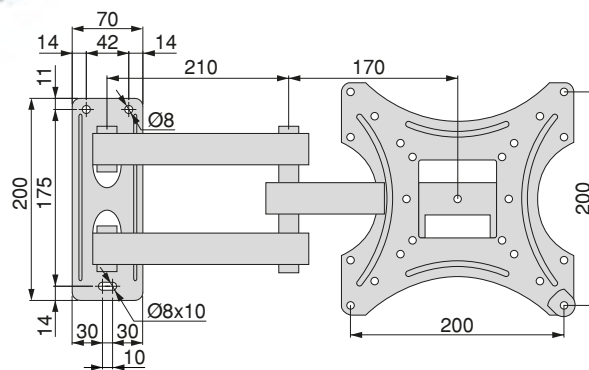

Giro1 Rotating base

Podstawa obrotowa Giro1



Finishing Wykończenie	Format Format	Cod.
Black painted Malowane na czarno	20 Ut/Szt	4952614

Steel
Stal

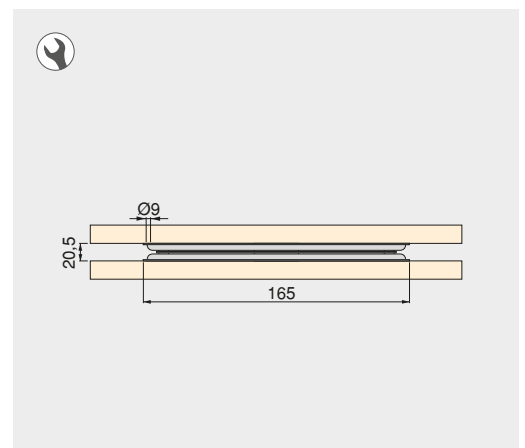
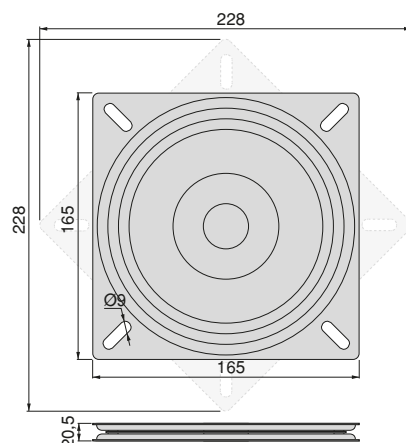

EXTENDING KEYBOARD SHELF RUNNER // PROWADNICE DO PÓLEK NA KLAWIATURĘ

CPU support

Uchwyt na komputer

Finishing Wykończenie	Format Format	Cod.
Silver painted Malowane aluminium	1 Ut/Szt	6216925

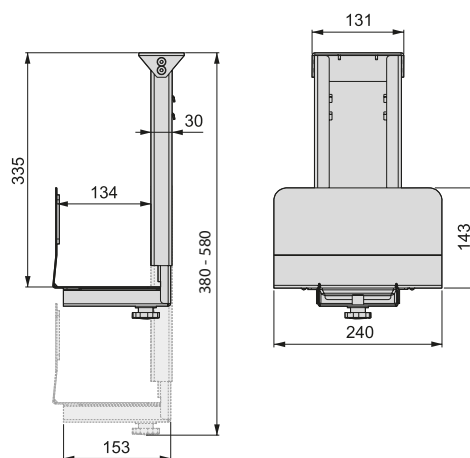
Steel
Stal

Mickey2 keyboard holder

Uchwyt na klawiaturę Mickey2

Finishing Wykończenie	Format Format	Cod.
Grey plastic Szary plastik	5 Ut/Szt	4193121

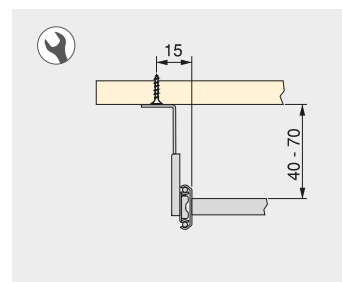
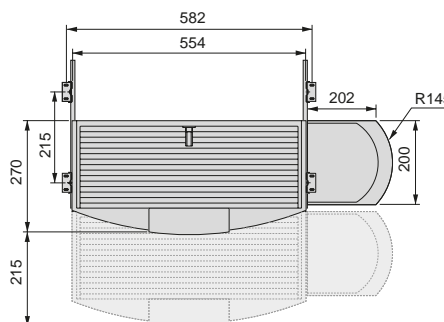
Plastic, Steel
Plastik, Stal

EXTENDING KEYBOARD SHELF RUNNER // PROWADNICE DO PÓLEK NA KLAWIATURĘ

Ball bearing keyboard holder runners kit, Steel

Zestaw prowadnic kulkowych do klawiatury z regulacją wysokości, stal

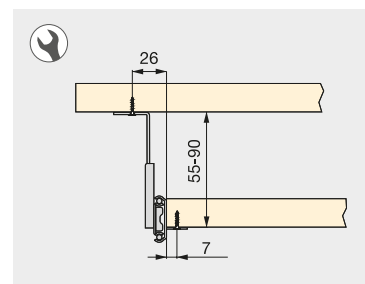
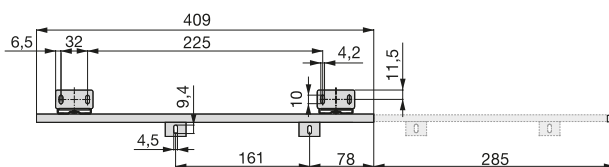

Finishing Wykończenie	Format Format	Cod.
Black zinc plated Cynkowana czerni	20 Ut/Szt	4193409

Steel
Stal

Set of ball bearing keyboard runners in steel

Zestaw prowadnic pod klawiaturę, stal

Finishing Wykończenie	Format Format	Cod.
Silver painted Malowane aluminium	1 Pair/Kpl.	3026025

Steel
Stal